



# SAN FRANCISCO BETTER STREETS PLAN POLICIES AND GUIDELINES FOR THE PEDESTRIAN REALM



## FINAL PLAN

ADOPTED BY THE SAN FRANCISCO BOARD OF SUPERVISORS ON DECEMBER 7, 2010



SAN FRANCISCO  
PLANNING  
DEPARTMENT

Mayor's Office on  
Disability



SFMTA | Municipal Transportation Agency





THE *BETTER STREETS PLAN* IS INTENDED TO ILLUSTRATE BEST PRACTICES AND PROVIDE A GUIDING DOCUMENT FOR ALL ACTORS WISHING TO MAKE CHANGES TO THE PUBLIC RIGHT-OF-WAY IN SAN FRANCISCO. THE *BETTER STREETS PLAN* IS EXPLICITLY INTENDED AS GUIDANCE ONLY, AS OPPOSED TO DEFINITIVE STANDARDS. THE *BETTER STREETS PLAN* DESCRIBES AND ILLUSTRATES TYPICAL SITUATIONS FOR THE DESIGN OF STREETS, SIDEWALKS, AND INTERSECTIONS, BASED ON TYPICAL STREET TYPES AND STANDARD STREET IMPROVEMENTS. INTERSECTION GEOMETRY, TOPOGRAPHY, TRANSPORTATION FACTORS, AND OTHER EXISTING CONDITIONS COMBINE TO CREATE MANY UNIQUE SITUATIONS. THE *BETTER STREETS PLAN* PROVIDES FLEXIBILITY FOR THE PROFESSIONAL TO DESIGN TO SPECIFIC CONDITIONS. TO THE GREATEST EXTENT FEASIBLE, THE GUIDELINES CONTAINED IN THIS DOCUMENT SHOULD BE FOLLOWED TO CREATE A PEDESTRIAN ENVIRONMENT THAT SERVES ALL USERS.





**Office of the Mayor**  
City & County of San Francisco



**Gavin Newsom**

June 2010

My Fellow San Franciscans:

I am pleased to present the Better Streets Plan Final Draft. This is a major milestone towards my vision of establishing a systematic, implementable program to bring about real and lasting change to San Francisco's streets.

Across the nation, forward-thinking cities are creating street design manuals as a tool to improve the quality and character of their neighborhoods and districts. In San Francisco, the Better Streets Plan creates a vision and provides guidelines for making the city's streets safer, greener and more enjoyable for all, following the City's Transit-First Policy and Better Streets Policy.

The Better Streets Plan is the result of a significant, inclusive public process. Department staff have held over 100 community meetings, gathered over 1,000 surveys, and received hundreds of comments into the Better Streets Plan. This plan truly represents the collective vision of the San Francisco community.

But the Better Streets Plan is just one step on the journey towards achieving truly world-class streets in San Francisco. As this document goes to print, my administration is bringing forward many street improvements towards a more livable public realm, including:

- **The Pavement to Parks program:** reclaiming underutilized portions of the roadway for vibrant public spaces
- **Better Market Street:** returning this once-great street to its rightful place at the center of San Francisco's civic life
- **The Great Streets Program:** improving neighborhood main streets such as Valencia Street, Leland Avenue, Divisadero Street, and Balboa Street to support local merchants and communities
- And many others

The Better Streets Plan illustrates that the City and community working together can realize actual street changes that improve San Francisco's streetscapes – to make our streets more useable and attractive and universally accessible to all, to make them safer and more welcoming, to improve their ecological functioning, and to return them to their rightful place as the center of civic life in this wonderful city. I commend all those involved in the drafting of this plan for their work.

We hope to have your full support in making San Francisco's streets part of a world-class public realm. We appreciate your on-going commitment to helping us plan Better Streets in San Francisco.

With my warmest personal regards,

Gavin Newsom  
Mayor, City and County of San Francisco

## Contact

For more information on the Better Streets Plan, contact:

Adam Varat, Project Manager  
San Francisco Planning Department  
415.558.6405  
adam.varat@sfgov.org

Visit our website at:

[www.sfbetterstreets.org](http://www.sfbetterstreets.org)





# SAN FRANCISCO **BETTER STREETS PLAN**

**POLICIES AND GUIDELINES FOR THE PEDESTRIAN REALM**

**FINAL PLAN**

ADOPTED BY THE SAN FRANCISCO BOARD  
OF SUPERVISORS ON DECEMBER 7, 2010

# Read this first: Navigating the Better Streets Plan

The Better Streets Plan guides the design of the pedestrian environment for all users. It's a long document, but most of the time users will only need to read certain portions. This page will help you quickly figure out where to look in the document for particular guidance.

## USERS

The Better Streets Plan is intended for a variety of users, including:

- **Decision-makers:** The Plan recommends policy directions and next steps to achieve a great pedestrian environment. See Chapter 3.
- **Street designers and managers:** The Plan sets guidelines to guide the design and use of the pedestrian environment, whether new streets, full streetscape re-designs, or design and placement of individual streetscape elements. See Chapters 4, 5, and 6.
- **Stakeholders:** The plan provides a resource and guide for community members, organizations, or private developers making streetscape improvements or seeking to understand the rules regarding design and use of the pedestrian environment. See Chapters 4, 5, and 6.

## DOCUMENT STRUCTURE

The Better Streets Plan consists of the following sections:

### *1. Introduction*

Background, overview of the plan process, and next steps.

### *2. Context*

Existing pedestrian and streetscape conditions, relevant federal, state, and local policies, and existing City planning efforts relating to street design.

### *3. Goals and Policies: The Path to Better Streets*

Plan goals, objectives, and policy directions to achieve Better Streets.

### *4. Approach: Designing Great Streetscapes*

Framework for design of the pedestrian realm by street type, and guidelines that apply to the pedestrian environment as a whole, such as sidewalk zones and general layout of streetscape elements.

### *5. Guide: Street Designs*

Guidelines for curb lines and related features, such as medians, curb extensions, and crosswalks.

### *6. Guide: Streetscape Elements*

Guidelines for individual streetscape elements, such as plantings, lighting, site furnishings, and utilities.

### *7. Implementation*

Recommendations for implementing Better Streets, including maintenance, enforcement, and funding strategies.

## Designing a street?

Follow these steps:

1. Determine street type (See Section 4.1)
2. Identify appropriate standard and additional elements for that street type (4.1)
3. See guidelines for overall design: sidewalk width, sidewalk zones, and layout of streetscape elements (4.2)
4. Follow specific guidelines for individual elements as necessary (Chapters 5 and 6)

## Locating a specific element?

Follow these steps:

1. See guidelines for overall design: sidewalk width, sidewalk zones, and layout of streetscape elements (Chapter 4)
2. Follow specific guidelines for the particular element (Chapters 5 and 6)



# Contents

<b>EXECUTIVE SUMMARY</b>	III
<b>1.0 INTRODUCTION</b>	01
1.1 BACKGROUND	03
1.2 PLAN DEVELOPMENT	11
1.3 MOVING FORWARD	15
<b>2.0 CONTEXT</b>	19
2.1 EXISTING CONDITIONS	21
2.2 REGULATORY CONTEXT	25
2.3 EXISTING CITY EFFORTS	29
<b>3.0 GOALS AND POLICIES: THE PATH TO BETTER STREETS</b>	35
3.1 VISION	36
3.2 PREFACE TO GOALS AND POLICIES	37
3.3 GOALS AND POLICIES	38
<b>4.0 APPROACH: DESIGNING GREAT STREETSCAPES</b>	53
4.1 STREET TYPES	55
4.2 OVERALL STREETSCAPE GUIDELINES	60
<b>5.0 GUIDE: STREET DESIGNS</b>	111
5.1 CROSSWALKS AND PEDESTRIAN SIGNALS	113
5.2 CORNER CURB RADII	123
5.3 CURB EXTENSIONS (BULB-OUTS)	127
5.4 MEDIANS AND ISLANDS	133
5.5 TRANSIT-SUPPORTIVE STREETSCAPE DESIGN	139
5.6 PARKING LANE TREATMENTS	147
5.7 TRAFFIC CALMING AND ROUNDABOUTS	153
5.8 PEDESTRIAN-PRIORITY DESIGNS	159
<b>6.0 GUIDE: STREETSCAPE ELEMENTS</b>	171
6.1 URBAN FOREST	173
6.2 STORMWATER MANAGEMENT TOOLS	187
6.3 LIGHTING	205
6.4 PAVING	211
6.5 SITE FURNISHINGS	217
6.6 UTILITIES AND DRIVEWAYS	233
<b>7.0 IMPLEMENTATION</b>	243
<b>AP APPENDICES</b>	234
A BETTER STREETS POLICY	251
B TRANSIT-FIRST POLICY	252
C "COMPLETE STREETS" POLICY	254
D SUMMARY OF COMMUNITY INVOLVEMENT	255
E SUMMARY OF ACCESSIBILITY GUIDELINES	256
F GLOSSARY	263
G SUMMARY OF PHYSICAL ELEMENTS IN THE BETTER STREETS PLAN	266





Cose Belle  
BOUTIQUE

*“Streets are almost always public: owned by the public, and when we speak of the public realm we are speaking in large measure of streets. What is more, streets change. They are tinkered with constantly: curbs are changed to make sidewalks narrower or (in fewer cases) wider, they are repaved, lights are changed, the streets are torn up to replace water and sewer lines or cables and again repaved. The buildings along them change and in doing so change the streets. Every change brings with it the opportunity for improvement. If we can develop and design streets so that they are wonderful, fulfilling places to be, community-building places, attractive public places for all people of cities and neighborhoods, then we will have successfully designed about one-third of the city directly and will have had an immense impact on the rest.”*

Allan Jacobs,  
*Great Streets*, MIT Press, 1995



# Executive Summary

## INTRODUCTION

The Better Streets Plan provides a blueprint for the future of San Francisco's pedestrian environment. It describes a vision, creates design guidelines, and identifies next steps to create a truly great pedestrian realm.

The Plan seeks to balance the needs of all street users, and reflects the understanding that the pedestrian environment is about much more than just transportation – that streets serve a multitude of social, recreational and ecological needs that must be considered when deciding on the most appropriate design. The Plan follows from the 'Better Streets Policy,' adopted by the Board of Supervisors and the Mayor in February 2006, which describes the varied roles that the City's streets should play.

The Better Streets Plan provides guidelines for the pedestrian environment, defined as the areas of the street where people walk, shop, sit, play, or interact – outside of moving vehicles. Generally speaking, this refers to sidewalks and crosswalks; however, in some cases, this may be expanded to include certain areas of the roadway. The Plan does not generally focus on roadway or vehicle travel characteristics.

If fully realized, the Better Streets Plan will bring a number of benefits to San Francisco. It will help retain families in San Francisco, support Muni and a transit-first city, help promote public safety, help to minimize sewer/stormwater overflows into the Bay, decrease the likelihood of pedestrian injuries and fatalities, increase accessibility for all street users, and enhance the everyday quality of life for San Francisco's residents.

This plan follows from a long public and technical process. City staff attended over 100 community meetings relating to the Better Streets Plan, held monthly meetings with a Community Advisory Committee, and received over 1,000 responses to the two Better Streets Plan surveys. As well, the Better Streets team has met with technical agency staff to gather comments regarding technical feasibility of initial concepts and proposals.

## PLAN HIGHLIGHTS

The Better Streets Plan contains a wide range of guidelines relating to streetscape and pedestrian facilities. Major themes and ideas include:

- **Distinctive, unified streetscape design:** Street trees as defining the streetscape rhythm; integrated site furnishings; regular pedestrian-oriented lighting; minimizing cluttering elements.
- **Space for public life:** Safe, useable public seating for neighborhood gathering; generous curb extensions for seating and landscaping; reclaiming of excess street space for public use; space for outdoor café and restaurant seating and merchant displays.
- **Enhanced pedestrian safety:** Safe, convenient pedestrian crossings; curb radii and curb extensions that slow traffic, shorten crossing distance, and enhance visibility; pedestrian countdown signals and other pedestrian priority signals (head-start, pedestrian scramble).
- **Improved street ecology:** On-site stormwater management to reduce combined sewer overflows; resource-efficient elements and materials; streets as green corridors and habitat connectors.
- **Universal design and accessibility:** Generous, unobstructed sidewalks, curb ramps for all users, accessible pedestrian signals.
- **Integrating pedestrians with transit:** Transit rider amenities at key stops; safe, convenient pedestrian routes to transit; mutual features that benefit pedestrian safety and comfort and transit operations, such as bus bulb-outs and boarding islands.
- **Creative use of parking lanes:** Permanent curb extensions with seating and landscaping; landscape planters in the parking lane; flexible, temporary use of the parking lane for restaurant seating or other uses.
- **Traffic calming to reduce speeding and enhance pedestrian safety:** Raised crossings and speed tables; landscaped traffic circles; chicanes.



Rendering by Allan B. Jacobs

- **Pedestrian-priority designs:** Shared public ways; temporary or permanent street closures to vehicles; sidewalk and median pocket parks.
- **Extensive greening:** Healthy, well-maintained urban forest; expanded sidewalk plantings; efficient utility location to provide more potential planting locations.

## NEXT STEPS

The Better Streets Plan is a vision for the future of the City's pedestrian environment. These suggested improvements are not extravagant or uncommon—they are in use in many cities across the state and nation. However, even typical street improvements cost money to build and maintain. To build out the Plan's recommendations on the City's streets, the City must have capital and maintenance funding in place—funding the City does not currently have. The City must continue to seek funding to realize the vision of the Better Streets Plan.

Better streets rely on successful implementation—ongoing capital funding, efficient maintenance, and effective education and enforcement. This plan describes a vision for ideal streets, and recognizes the need to have detailed implementation strategies. The plan identifies high-level implementation measures. Other recommendations have been developed in an accompanying report by the Controller's Office.

The Better Streets Plan is merely the first step to realizing an improved pedestrian environment and public realm in San Francisco. It sets high-level guidelines that should be used in the City's on-going streetscape and pedestrian design. It does not seek to prioritize or create a project list of Better Streets projects. Nor does it give specific engineering guidance on a number of technical topics—those standards may be found in other existing or planned documents.

In order to implement the vision of the plan, the City must take a variety of next steps, including the following:

- Improve the coordination and delivery of street improvements.
- Create an easy to use Better Streets guide and website.
- Develop a framework for implementation and prioritization of street improvement projects.
- Develop additional technical guidance on a number of topics, including: urban forest, stormwater, street and pedestrian lighting, street furnishing, and roadway design guidelines.

## CHAPTERS

The Better Streets Plan consists of the following chapters:

1. Introduction
2. Context
3. Goals and Policies: The Path to Better Streets
4. Approach: Designing Great Streetscapes
5. Guide: Street Designs
6. Guide: Streetscape Elements
7. Implementation

### 1.0 INTRODUCTION

Chapter 1 gives background on the plan, describes the plan development, and identifies next steps, and is summarized above.

### 2.0 CONTEXT

Chapter 2 describes existing conditions and policies relating to streets and the pedestrian environment in San Francisco today.

### 2.1 Existing conditions

Walking accounts for 20% of all trips made in San Francisco<sup>1</sup>. Major activity generators include transit hubs, schools, hospitals and shopping centers. Pedestrian volumes are highest in the northeast quadrant of the city, and along major transit corridors. Pedestrian collisions and fatalities have been generally declining over time, though still remain significant. Many pedestrian collisions are concentrated in a few areas of the city.

Streetscape and pedestrian infrastructure includes signs and signals, sidewalks, curb ramps, street trees, street lighting, site furnishings, and stormwater infrastructure. San Francisco's street and sidewalk infrastructure varies greatly, as does data on the condition of these features. The City is engaged in collecting on-going data on a number of features.

### 2.2 Existing policies

Street design in San Francisco is subject to federal, state, and local policies, standards, and guidelines. Key federal and state policies and standards include the Americans with Disabilities Act (ADA) and related documents, the California Manual on Uniform Traffic Control Devices (MUTCD), the California Vehicle Code (CVC), American Association of State Highway and Transportation Officials (AASHTO) standards, the California Environmental Quality Act (CEQA), and the Clean Water Act and National Pollutant Discharge Elimination System (NPDES) permit, which regulates stormwater runoff into receiving waters.

Locally, San Francisco has passed the 'Transit-First Policy' (City Charter Section 16.102) and the 'Better Streets Policy' (Administrative Code Chapter 98), which prioritize street improvements that enhance transit trips over other transportation modes, and require the City to coordinate to create streets that are pedestrian-oriented and multi-functional, respectively. Additional City policies can be found in the San Francisco General Plan and its constituent elements. The Countywide Transportation Plan also

<sup>1</sup> San Francisco County Transportation Authority



guides street improvements. City standards and guidelines relating to street design can be found in the Administrative Code, Building Code, Fire Code, Planning Code, Public Works Code, Transportation Code, and in departmental orders, design guidelines, and standard plans.

### 2.3 Existing City efforts

The City has a number of on-going projects and programs relating to street improvement. Responsibility for street planning, design, funding, regulation, maintenance, education, and enforcement is spread over several departments. Though there are many good projects, there is often inconsistency in the results, and the process can be expensive, time-consuming, and confusing.

## 3.0 GOALS AND POLICIES: THE PATH TO BETTER STREETS

Chapter 3 describes an overall vision for better streets. It describes goals, objectives, policies, guidelines, and next steps to achieve a great pedestrian environment, based on the following “10 Elements of Better Streets.”

Streets should (be):

1. **Memorable:** San Francisco’s streets should be designed to give the city and its neighborhoods a recognizable image and provide a means of orientation and understanding of the city.
2. **Support diverse public life:** San Francisco’s streets should provide opportunities for diverse experiences and encourage people to spend time engaging in social and recreational activities.
3. **Vibrant places for commerce:** San Francisco’s streets should be designed and managed as attractive and exciting destinations that encourage residents and visitors to walk to and use local shopping areas, rather than to drive to regional shopping centers.
4. **Promote human use and comfort:** San Francisco streets should be designed to prioritize the everyday needs of people and to support human comfort and enjoyment.

5. **Promote healthy lifestyles:** San Francisco’s streets should promote healthy lifestyles by encouraging walking to daily and occasional destinations, minimizing pedestrian injuries and helping to decrease major chronic diseases related to air quality and pedestrian activity.
6. **Safe:** San Francisco’s streets should be designed to create a street environment that supports a high level of pedestrian safety and security.
7. **Create convenient connections:** San Francisco’s streets should be designed to facilitate safe, accessible, and convenient connections among major nodes, hubs, destinations, transit centers, and major land use and activity centers.
8. **Ecologically sustainable:** San Francisco’s streets should be designed as a green network, enhancing the City’s long-term ecological functioning.
9. **Accessible:** San Francisco streets should be designed for ease of use and access to destinations for all populations, particularly those with visual or mobility impairments.
10. **Attractive, inviting, and well-cared for:** San Francisco’s streets should be beautiful, create an engaging visual impression, appeal to senses of sight, smell, and sound, and encourage a sense of ownership and civic pride that is reflected in streets’ physical appearance and level of activity.

## 4.0 APPROACH: DESIGNING GREAT STREETSCAPES

Chapter 4 sets a framework for overall streetscape design. It is divided into two sections: 4.1 Street Types; and 4.2 Overall Streetscape Guidelines.

### 4.1 Street Types

Different streets play different roles, so this chapter begins by categorizing streets into different street types for the purposes of streetscape design. Street classifications are based on land use characteristics (residential, commercial,

industrial, mixed-use) and transportation roles (downtown, throughway, neighborhood). Special streets (parkways, park edge streets, boulevards and ceremonial (civic) streets), and small streets (alleys, shared public ways, and pedestrian-only streets) are called out separately. These classifications are not intended to replace technical transportation classifications, but to help make decisions about streetscape design.

Section 4.1 shows a typical site plan and section for each street type, using recommended sidewalk widths, pedestrian facilities, and streetscape amenities. For each street type, the Plan lists standard improvements (such as street trees, curb ramps, marked crossings, and site furnishings) and case-by-case additions (such as mid-block crosswalks, landscaped center medians, perpendicular or angled parking with corner plazas, and extended bulb-outs with landscaping and seating). Standard additions should generally be included in any streetscape design project on a particular street type. Case-by-case additions should be considered as budgets, physical conditions, and neighborhood preferences allow.

### 4.2 Overall Streetscape Guidelines

Section 4.2 provides overall guidelines for the streetscape environment. Streetscapes should be designed to encompass a variety of features and amenities, and reflect a unified design sensibility. Streetscape projects should be combined wherever possible to provide ‘completeness’ in streetscape design. For example, curb ramp projects may be combined with building curb extensions, which could house seating, landscaping, and stormwater treatment measures.

Section 4.2 describes appropriate elements and treatments for intersection design, including marked crosswalks, curb ramps, parking restrictions at corners, tight turn radii, curb extensions, pedestrian refuge islands, street trees, street and pedestrian lighting, and site furnishings. These elements should be combined to create a safe, convenient, inviting intersection for pedestrians.

Next, Section 4.2 discusses sidewalk widths and zones. Sidewalks are divided into five zones: frontage, through-way, furnishings, edge, and ‘extension.’ These terms are used throughout the document. Minimum and recommended sidewalk widths are given for each street type. Sidewalks below minimum width should be considered deficient, and should be widened as opportunities and funding allow. Recommended widths are wide enough to allow for desired streetscape amenities. Sidewalks on new streets should meet or exceed recommended widths.

Finally, this section describes guidelines for overall layout of streetscape elements. Streetscapes should wisely allocate limited space, strive for ‘wholeness’, and accommodate pedestrian needs. Street trees should define the rhythm of the streetscape, and be the primary organizing element. Conflicts with ideal street tree locations should be minimized to achieve this rhythm. Street and pedestrian lighting may be placed in an off-setting rhythm. Other site furnishings should be placed in relation to these elements, per appropriate clearances, discussed in Chapter 6.

## 5.0 GUIDE: STREET DESIGNS

Chapter 5 describes guidelines for street designs such as curb geometries, crosswalks, parking lanes, and special street conditions. It is divided into eight sections: 5.1 Crosswalks and Pedestrian Signals; 5.2 Corner curb radii; 5.3 Curb extensions; 5.4 Medians and Islands; 5.5 Transit-Supportive Streetscape Design; 5.6 Parking lane treatments; 5.7 Traffic calming and roundabouts; and 5.8 Pedestrian-priority designs.

### 5.1 Crosswalks and Pedestrian Signals

Crosswalks are an essential part of a safe, convenient pedestrian realm, and may also be an urban design treatment. This section describes guidelines for location and design of marked crosswalks at intersections and mid-block locations, special treatments such as raised crossings, special paving treatments, and special signals, pedestrian signals, and vehicle movements at intersections, including right turns on red and multiple turn lanes.

### 5.2 Corner curb radii

Corner curb radii (turn radii) have a major impact on pedestrian safety and quality. Tight turn radii slow turning vehicles, shorten crossing distances and enhance visibility. Turn radii should be as tight as possible to enhance pedestrian comfort; however, they should be designed to accommodate turning vehicles as well per the guidelines. This section also presents alternative strategies for dealing with intersections with frequent large turning vehicles.

### 5.3 Curb extensions

Similar to curb radii, curb extensions slow turning vehicles, shorten crossing distances and enhance visibility by extending the sidewalk into parking lanes. Corner curb extensions should be a standard treatment on most street types. They should be designed to maximize pedestrian space. Generous curb extensions may allow opportunities for landscaping, seating, and stormwater management. They may also be placed at mid-block locations to create a small plaza.

### 5.4 Medians and islands

Medians are continuous raised areas within the roadway that control traffic, and may have a traffic calming, greening, and ecological benefit. They may also provide pedestrian refuges at crossings. Medians should include trees and other landscaping as appropriate. Islands are smaller raised areas within the roadway. They may provide a pedestrian refuge, traffic calming, or design feature.

### 5.5 Transit-Supportive Streetscape Design

Most transit rides begin or end on foot. People waiting at transit stops are some of the most frequent users of the pedestrian realm. Transit waiting areas should be designed with amenities for waiting riders. They must also be accessible to all users and provide clear paths to and from the transit shelter and vehicle. Bus bulbs and transit boarding islands may be used to improve transit operations and also provide greater sidewalk space.

### 5.6 Parking lane treatments

In many cases, the pedestrian environment may be extended into the parking lane, either permanently or temporarily. Curb extensions are one way of achieving this. Providing perpendicular or angled parking where roadway width allows can also allow for the creation of significant corner plazas. Alternative uses for the parking lane are also considered, including landscaped planters, bicycle parking, and flexible (temporary) use of the parking lane for outdoor seating.

### 5.7 Traffic calming and roundabouts

Traffic calming enhances pedestrian safety and neighborhood character by slowing traffic. Traffic calming measures discussed in this plan include traffic circles and chicanes. These should be designed to slow traffic by visually narrowing the street and forcing cars to shift laterally. They may also present opportunities for landscaping, stormwater treatment, and community stewardship. Roundabouts are traffic control devices with limited applicability in San Francisco. Where they are used, consideration should be given to pedestrian safety, accessibility, and wayfinding.

### 5.8 Pedestrian-priority designs

Pedestrian-priority designs are special cases that provide more than the standard sidewalk space for pedestrians. These include: sidewalk and median pocket parks, shared public ways, local lanes and medians on multi-way boulevards, pedestrian-only streets, and public stairs. In all cases, the pedestrian area or shared pedestrian/vehicle area should be designed to slow traffic and indicate areas of pedestrian priority. They may also be opportunities to create significant public spaces.



## 6.0 GUIDE: STREETScape ELEMENTS

Chapter 6 describes guidelines for streetscape elements typically found in sidewalks or curb extensions, including: street trees and plantings, stormwater control measures, street and pedestrian lighting, paving, site furnishings, utilities, and driveways.

### 6.1 Urban forest

The urban forest consists of street trees, understory plantings (ground landscaping), and above-ground plantings (planter boxes or hanging planters). Urban forest elements should be appropriate to soil and microclimate zones. Drought-tolerant and climate-adapted species should be used. Native plantings should be used when it is possible to maintain healthy plantings.

Street trees should be the primary organizing element of the streetscape; restrictions and conflicts with other elements should be minimized to ensure consistent plantings. Tree basins should be optimized to ensure tree health and minimize root interference with sidewalks. Tree furnishings such as grates, guards or railings may be used for a design treatment; however, they may be difficult to maintain or inhibit tree health.

Understory plantings should be used in furnishings zones on most street types, with sufficient area for healthy plantings. They may have a formal or more naturalistic treatment, depending on the context. Sidewalk landscaping may be present and still allow access to parked cars and utilities if designed properly. Above-ground landscaping is appropriate in limited circumstances such as in special design areas, or where in-ground landscaping is not possible due to utilities or other constraints.

### 6.2 Stormwater control measures

Stormwater control measures are on-street stormwater facilities that capture stormwater before it enters the City's combined or separate stormwater systems. This treatment

can result in fewer combined sewer overflows into the bay or ocean. Stormwater control measures can be designed to infiltrate, retain, detain, convey, and treat stormwater. Infiltration may not be possible in all locations. For more technical details, refer to the San Francisco Stormwater Design Guidelines.

Stormwater management tools include permeable paving, bioretention facilities, swales, channels and runnels, infiltration trenches, infiltration boardwalks, vegetated gutters, and vegetated buffer strips. All of these features may be designed to be integral, aesthetic parts of the streetscape in addition to their stormwater management role.

### 6.3 Lighting

Street lighting is a key organizing element that defines the daytime and nighttime environment and enhances personal safety and security. Street lights should light the entire right-of-way; specific pedestrian-oriented lighting is appropriate in downtown, civic, and commercial areas with high numbers of pedestrians. Lighting should be spaced to optimize light distribution and not interfere with other streetscape elements, particularly street trees. Street lights should use energy efficient technologies, and minimize light loss to the night sky. Lighting guidelines should be further developed through a street lighting master plan.

### 6.4 Paving

Paving materials in the pedestrian realm can be either standard concrete or non-standard materials, such as brick, stone, or unit pavers. Paving should be functional—stable, firm, slip-resistant, and relatively easy to maintain. It may also provide a unique design treatment, particularly on special streets or in areas of the street environment meant for pausing rather than walking through. Special paving may be considered at transit stops, crosswalks, pedestrian refuges, shared public ways, local lanes of boulevards, transit malls, pedestrian-only streets, flexibly used parking lanes, curb extensions, or in the furnishings zone of the sidewalk.

### 6.5 Site furnishings

Site furnishings consist of all streetscape amenities in the sidewalk, including: benches and seating, bicycle racks, bollards, flowerstands, kiosks, newsracks, parking meters, public art, sidewalk restrooms, traffic and parking signs, trash receptacles, and signage and gateways. Generally, site furnishings should be located in the furnishings zone. Site furnishings should be considered design elements, and use consistent, aesthetic design along a particular street or corridor. They should meet basic clearances and requirements for accessibility, maintenance, and safety.

### 6.6 Utilities and driveways

Utilities and driveways are functional elements that provide necessary access and facilities. Utilities may be poles, overhead wires, surface-mounted boxes, underground vaults, mains and laterals. They are a necessary and ubiquitous element of streetscape environments; however, they often conflict with other streetscape elements, and vice versa.

Utilities should be efficiently located to minimize impacts on other existing or potential streetscape elements, maintain basic access and maintenance requirements, and be consolidated into shared vaults, boxes, or trenches wherever possible. Likewise, driveways should be minimized and located to avoid impacts to existing or potential streetscape elements.

## 7.0 IMPLEMENTATION

Chapter 7 describes implementation measures necessary to carry out the vision of the Better Streets Plan, including funding, maintenance, and enforcement strategies. The Controller's Office report: "Better Streets Plan: Recommendations for Improved Streetscape Project Planning, Design, Review and Approval" contains additional implementation recommendations.



# CHAPTER

# 10



CHAPTER

# 1.0

INTRODUCTION

- 1.1 Background
- 1.2 Plan Development
- 1.3 Moving Forward

# INTRODUCTION

The Better Streets Plan provides a blueprint for the future of San Francisco's pedestrian environment. It describes a vision, creates design guidelines, and identifies next steps for the City to take to create a truly great pedestrian realm.





*What is a Better Street?*

A Better Street is designed and built to strike a balance between all users regardless of physical abilities or mode of travel.

A Better Street attends to the needs of people first, considering pedestrians, bicyclists, transit, street trees, stormwater management, utilities, and livability as well as vehicular circulation and parking.



# Background

## 1.1

### BETTER STREETS PLAN PURPOSE

Streets make up fully 25% of San Francisco’s land area, more area even than is found in the city’s parks. The City’s streets are one of its most memorable features; the city’s famous hilly terrain is made all the more scenic by the steady march of streets over its rolling topography to the water’s edge. However, the scenic vistas visible from and along so many of the city’s streets have made it too easy to ignore the untapped potential of the streets themselves—San Francisco’s streets are vastly underutilized resources.

San Francisco is renowned for its quality of life, commitment to social equity and growing concern for environmental sustainability. The City’s Charter declares that transit, bicycle, and pedestrian use of street space take precedence over private vehicle use. The City strives to

provide services, infrastructure, and lifestyle opportunities for people from all walks and stages of life: families with children, young professionals, senior citizens, and everyone inbetween. These goals seek to maintain and enhance San Francisco’s role as one of the premier world cities.

As San Francisco continues to mature and evolve it faces many challenges in supporting this vision of itself as a world-class city. Families with children are leaving the city more quickly than they are arriving. Pedestrian injuries and fatalities continue to occur on busy streets. Many neighborhoods lack open space for recreational activities or places for neighbors to gather. The quality of streets and public spaces is slowly deteriorating amid structural budget deficits. The need to address concerns about air and

▼ Noe Street





water quality and global climate change grows increasingly urgent each passing day. Well-designed streets that serve a multitude of uses can help to address these concerns.

Each year, the City spends millions of dollars maintaining and improving city streets, yet too often the streets serve only a single purpose—the movement of automobiles. With improved planning and coordination, San Francisco could use this money to transform its streets to meet the City’s many objectives for streets, including enhancement of all types of travel, improved ecological performance, encouragement of physical activity for public health, and restoring the streets’ rightful role as the heart of the city’s public life.

The Better Streets Plan provides a blueprint for achieving this multi-use vision of streets – streets that continue to function as corridors of movement while at the same time reach their potential for enhanced community life, recreational opportunities, and ecological benefits. As San Francisco continues to grow, the Better Streets Plan will help to ensure that it can fulfill its vision of a world-class city – one that is renowned not just for the views from its streets, but for the quality of the streets themselves and the vibrant public life that they foster.

## PLAN BENEFITS

The Better Streets Plan describes a set of guidelines for the pedestrian realm. As street improvements are built over time using the Better Streets Plan, the City will realize a number of essential benefits from improved street design. These benefits include:

- **Help retain families in San Francisco:** Streets that are safe from fast-moving traffic, are clean and well-maintained, and have spaces for neighbors to gather or children to play will help to retain families in San Francisco, much as affordable housing or good public schools will do the same.
- **Support Muni and a transit-first city:** Every transit trip begins and ends with a walking trip. Well designed streets that are safe and convenient for pedestrians and connect to important transit lines will encourage greater use of the transit system.
- **Help promote public safety:** Active streets that provide ‘eyes on the street’ will enhance peoples’ sense of safety and security from crime and violence.
- **Help improve public health:** Walkable, livable streets encourage physical activity and social cohesion, leading to a decrease in obesity, chronic diseases, and social isolation.

## ➔ Benefits of the Better Streets Plan

- Help retain families in San Francisco
- Support Muni and a transit-first city
- Help promote public safety
- Help improve public health
- Help to minimize impact on global climate change and local air pollution
- Help to minimize sewer/stormwater overflows into the Bay
- Decrease the likelihood of pedestrian injuries and fatalities
- Increase accessibility for all street users
- Support the City’s local shopping districts and small businesses
- Support neighborliness, civic interaction, and identity
- Enhance the everyday quality of life for San Francisco’s residents

### ➔ What is the pedestrian environment?

The term “pedestrian environment” refers to the areas of the street where people walk, shop, sit, play, or interact – outside of moving vehicles. Generally speaking, this refers to the sidewalk areas between the property line and the curb, and the crossing areas at intersections. However, the pedestrian environment can also include portions of the street normally associated with vehicular traffic—such as during street fairs or farmer’s markets, or the entire street on small streets such as alleys or pedestrian pathways.



The pedestrian environment







▲ Recent San Francisco projects such as Octavia Boulevard (top) and Mint Plaza (bottom) show how streets can be transformed into active and green public spaces

- **Help to minimize impact on global climate change and local air pollution:** Streets that are designed to promote walking, cycling, and transit use over private automobile use will help to minimize San Francisco's contribution to global climate change and reduce local air pollution.
- **Help to minimize sewer/stormwater overflows into the Bay:** Streets can be designed to detain a certain percentage of water during big storms, to reduce overflows of the City's combined stormwater and sewer infrastructure into the bay and minimize local flooding problems.
- **Decrease the likelihood of pedestrian injuries and fatalities:** Streets that are designed with the safety of pedestrians in mind will decrease the likelihood of pedestrian/auto collisions and the number of pedestrian injuries and fatalities that occur each year.
- **Increase accessibility for all street users:** Streets that have a clear, accessible path of travel and are free from barriers and obstructions will result in increased usability for all users, including people with disabilities, seniors, children, parents with strollers, and everyone else.
- **Support the City's local shopping districts and small businesses:** A street system that encourages people to walk to neighborhood commercial districts rather than drive to regional shopping centers for their daily needs helps to support the small commercial areas and small businesses that make up an important part of San Francisco's character and economy.
- **Provide open space in areas that are lacking:** There is increasing pressure on the City's existing open spaces, and a need for open space in new neighborhoods. The city's street system can complement and link to the larger open space network, bringing more open space to underserved neighborhoods.

- **Support neighborliness, civic interaction, and identity:** Cities depend on peaceful interactions of colleagues, neighbors, and strangers who share a collective identity and pride as the residents of a place. Well-designed streets that include places to sit, stop, gather, and play create the spaces for this interaction to take place.
- **Enhance the everyday quality of life for San Francisco's residents:** Above all, a well-designed street system will enhance the City's livability for San Francisco's residents, workers, and visitors, by providing pleasant places to stroll or sit, opportunities for neighborly interaction, freedom from excessive noise and pollution, and a green, attractive cityscape.

For the Better Streets Plan to help achieve these benefits, the City must reform many of its current standards, guidelines, and practices relating to street design, construction and maintenance. These practices, standards and guidelines—found in the City's codes, plans, and departmental orders—are strong determinants of the resulting street environment that we see and use everyday. Many of these codes are old or out of date, and often conflict with one another. Many were adopted during times when thinking about streets, technologies, and ecological best practices was different than it is today, and often reflect a single-use vision for streets that does not account for the multitude of uses that streets can serve.

The Better Streets Plan seeks to balance and reconcile these codes while considering all potential street uses; the legislation accompanying the Better Streets Plan adoption updated many of these codes.

Additionally, there must be an on-going commitment from the City to ensure that future changes to the public right-of-way are consistent with the Better Streets Plan. This document provides a guide for City agencies, community members, and private developers and anyone else making changes to the pedestrian realm. This guide must be complemented with an on-going commitment from the City's elected officials and department heads to funding, staffing, building, and maintaining Better Streets improvements.



**DISTINCTIVE, UNIFIED OVERALL DESIGN**



- Integrated site furnishings [Section 6.5]
- Pedestrian-oriented lighting [6.3]
- Minimize site cluttering [6.5]

**SPACE FOR PUBLIC LIFE**



- Reclaim excess street space for public use [5.8]
- Safe public seating for neighborhood gathering [6.5]
- Merchant participation [6.5]

**PEDESTRIAN SAFETY**



- Visible crossings [5.1]
- Slower turning speed [5.2]
- Shorter crossing distances [5.3]

**PEDESTRIAN PRIORITY**

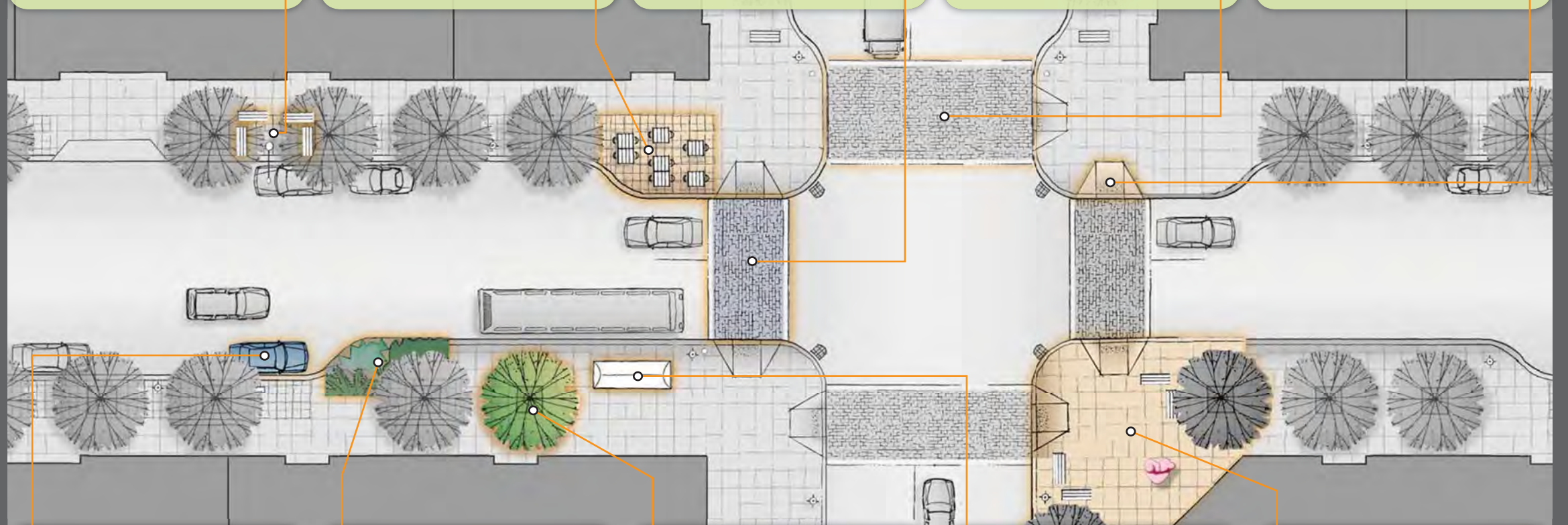


- Shared public ways [5.8]
- Temporary or permanent street closures [5.8]
- Raised crossings [5.1]

**UNIVERSAL DESIGN**



- Generous, unobstructed sidewalks [4.2]
- Curb ramps for all users [5.1]
- Accessible pedestrian signals [5.1]



**CREATIVE USE OF PARKING LANE**



- Flexible use for cafe seating [5.6]
- Permanent mini-plazas [5.3]
- Landscaping in the parking lane [6.1]

**ECOLOGY**



- Stormwater management [6.2]
- Permeable materials [6.2]
- Streets as habitats [6.1]

**EXTENSIVE GREENING**



- Healthy urban forest [6.1]
- Expanded sidewalk plantings [6.1]
- Utility consolidation [6.6]

**INTEGRATING PEDS AND TRANSIT**



- Transit rider amenities [5.5]
- Bus bulbouts and boarding islands [5.5]
- Safe, convenient routes to transit [5.5]

**RECLAIMING EXCESS STREET SPACE**



- Street parks and new plazas [5.8]
- Traffic circles [5.7]
- Landscaped medians [5.4]

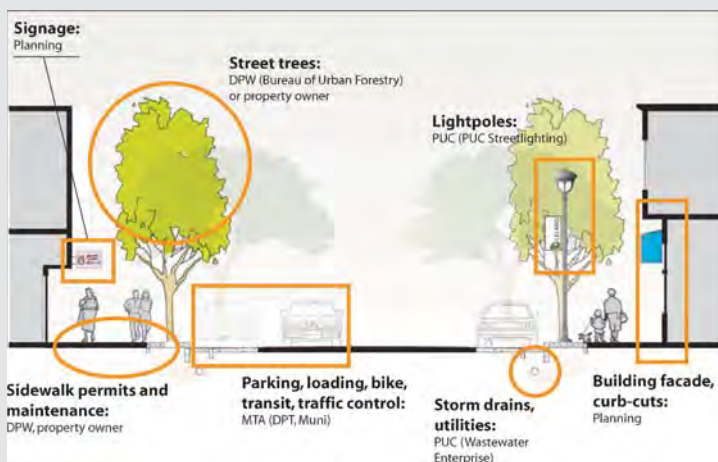


## ➔ Street Delivery in San Francisco

Streets in San Francisco are regulated and managed by a variety of agencies, reflecting specific areas of expertise. Although this is sometimes necessary to provide specific technical know-how, there is no one body coordinating streetscape design projects. As a result, individual decisions about street design, use, prioritization, and management do not add up to streets that reflect the City's goals for the character of our streets.

The Better Streets Plan posits a new manner of designing and building streets in San Francisco. Streets should be designed with greater agency coordination, and individual decisions should add up to an integrated whole that prioritizes the needs of people. Each design or management decision should bring the City closer to the collective vision for streets.

As a follow-up action to the Better Streets Plan, the Controller's Office has analyzed the City's street design process and made recommendations for its improvement. See the Controller's Office report: "Better Streets Plan: Recommendations for Improved Streetscape Planning, Design, Review, and Approval," available at [www.sfbetterstreets.org](http://www.sfbetterstreets.org).

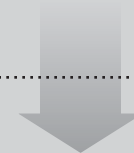


▲ Jurisdiction over streets is divided among numerous agencies, including those shown here, and others as well

### PROCESS

#### Business as usual

- Independent agencies with competing goals
- Lack of overall framework for street improvements
- Lack of coordination for street programming and funding
- Ad hoc coordination on street design and use
- Planning for individual elements
- Competing visions for streets/lack of overall vision for streets



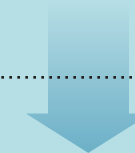
- City priorities not clearly defined
- Uncoordinated use of City resources

### RESULT

- Cluttering streetscape elements
- Streets with lack of unifying aesthetic
- Streets that do not serve well as public spaces
- Lack of greenery
- Lack of ecological functioning

#### Better Streets Plan

- Coordinated agencies working toward citywide goals
- Integrated framework for street improvements
- Coordinated programming and funding for street improvements
- Centralized coordination on street design and use
- Planning for streets as a whole
- Unified vision for streets



- Citywide priorities clearly defined
- Efficient use of City resources
- More numerous and more complete street projects
- Multi-purpose projects with greater competitiveness for funding
- Unified street design
- Fewer cluttering streetscape elements
- Streets with a healthy public realm
- Increased greenery and ecological functioning
- Enhanced safety and accessibility





◀ This photo-simulation illustrates how the Better Streets Plan guidelines could be applied to a typical mixed-use San Francisco street to improve the pedestrian environment



Photosimulations are for visualization purposes only, and are not intended to show specific details and dimensions



This photo-simulation illustrates how the Better Streets Plan guidelines could be applied to improve the pedestrian environment on a typical residential San Francisco street





A grayscale photograph of a tree-lined street. The street is lined with large, mature trees on both sides, creating a canopy effect. Several cars are parked along the street, including a white SUV on the left and a white pickup truck on the right. A person is visible walking on the sidewalk on the left side of the street. The overall scene is peaceful and well-maintained.

The Better Streets Plan  
is a partnership among  
City departments and  
agencies, with the goal  
of coordinating and  
streamlining the City's  
street design processes and  
resulting in a more gracious  
pedestrian realm.



# Plan Development

# 1.2

## HISTORY OF THE PLAN

In February 2006, the Board of Supervisors passed the ‘Better Streets Policy’ (Administrative Code Section 98.1—shown in Attachment A), which requires the City to consider the multiple objectives for streets in all decisions about the public right-of-way. Responding to this policy, City departments joined together to work on the Better Streets Plan, to provide a single comprehensive, consistent set of guidance for the design of the pedestrian realm.

Work on the Better Streets Plan began in Fall 2006, with a public kick-off in April 2007. The Better Streets Plan Draft for Public Review was published in June 2008, Plan Revisions in October 2009, and the Final Draft in July 2010. The Better Streets Plan and accompanying amendments to the City’s General Plan and Municipal Codes were adopted by the Board of Supervisors on December 7, 2010.

The Better Streets Plan is a unique collaboration among all of the agencies involved in the funding, design, and management of streets citywide, including the Planning Department, San Francisco Municipal Transportation

Agency (SFMTA), San Francisco Public Utilities Commission (SFPUC), Department of Public Works (DPW), Department of Public Health (DPH), Mayor’s Office on Disability (MOD), Mayor’s Office on City Greening, and the San Francisco County Transportation Authority (SFCTA). Staff from each of these agencies (the “Better Streets team”) met bi-weekly to develop the plan, and gave frequent updates to Department leadership.

The Better Streets team convened a wider Technical Advisory Committee (TAC) of over 50 staff from 15 City departments who work in design and management of the public right-of-way. The Better Streets Plan TAC met multiple times over the course of the project to comment on the technical feasibility of plan proposals.

Additionally, the Better Streets team convened a 15 member Community Advisory Committee, which met monthly over a two-year period to provide input into plan as it was developed. Finally, the Better Streets Team held a significant public outreach program, summarized in the following section.



## SUMMARY OF PUBLIC OUTREACH

In order to create the Better Streets Plan, the Better Streets Team conducted significant community involvement efforts to present plan concepts and gather public input. Over five rounds of community involvement, the Better Streets Team held over 100 community meetings, and received over 1,000 responses to two Better Streets Plan surveys.

Mayor Gavin Newsom kicked off the community involvement for the Better Streets Plan in April 2007, at a project kick-off meeting at City Hall attended by over 200 members of the public. Following the kick-off meeting, in April through June 2007, City agencies held four public workshops around the city, seven focus groups, and over 25 neighborhood meetings with community groups by request.

The second round of outreach took place from July through September 2007, and consisted of over 40 events, including focus groups, stakeholder interviews with a variety of advocacy and community organizations, neighborhood meetings with community groups, street-side tabling events, and a youth walking tour.

In June 2008, Mayor Gavin Newsom formally released the Draft Better Streets Plan for Public Review at a public event in Mint Plaza. Following the plan release event, the Better Streets Team held a third round of outreach to

gather feedback on the Draft Plan, consisting of several community meetings and a walking tour. The fourth round of outreach, held in October 2009 to coincide with the release of the Plan Revisions, consisted of public informational hearings to the City's Boards and Commissions, and public discussions hosted by local organizations. The fifth and final round of outreach involved public hearings to adopt the Plan and associated legislative amendments.

A full list of community meetings is included in Appendix D.

Through the public outreach, participants could give their input in multiple ways, including facilitated small group exercises, comment boards, questions and answer sessions, surveys, comment sheets, and informal discussion and correspondence.

Respondents to the first Better Streets Plan survey rated the five most important street improvements as:

- street trees;
- greenery (landscaping other than trees);
- sidewalk maintenance;
- clear sidewalks (free from obstructions); and
- slower traffic.

### Round 1 Survey Responses:

Average Score for Street Improvements  
(Scale of 1 to 7, 7 being most important)

Trees	5.6
Greenery	5.4
Sidewalk Maintenance	5.3
Blocked Sidewalks	5.3
Slower Traffic	5.3
Pedestrian Lighting	5.1
Places to Sit	5.0
Crosswalk Conditions	5.0
Sidewalk Materials	4.8
Countdown Signals	4.8
Wider Sidewalks	4.6
Narrow Street Crossings	4.1
Curb Ramps	4.0

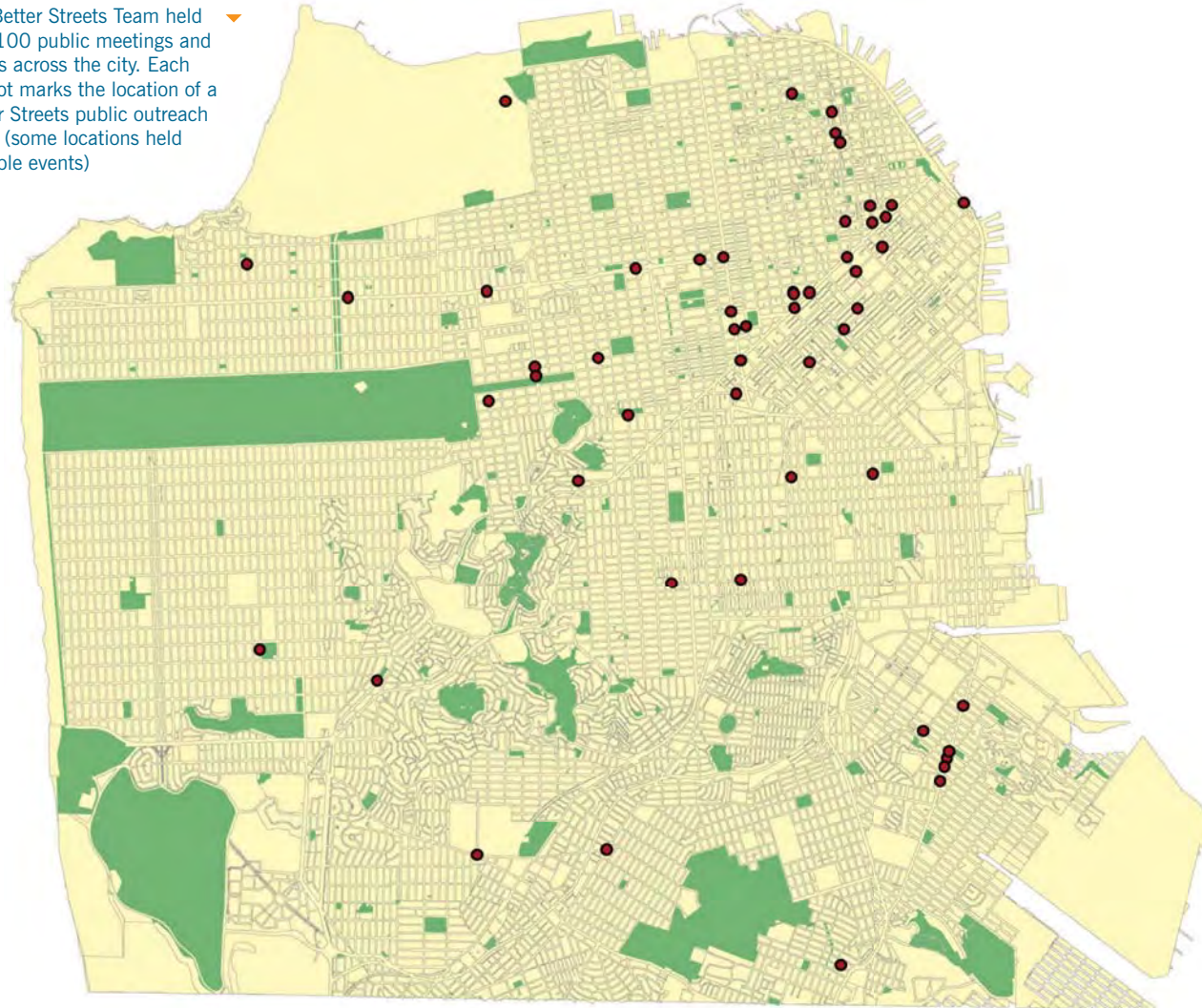


◀ Better Streets Plan kick-off event at City Hall (left) and street-side tabling event (right)

A broader summary of community input is included in Appendix D.



The Better Streets Team held over 100 public meetings and events across the city. Each red dot marks the location of a Better Streets public outreach event (some locations held multiple events)



### Community Involvement Milestones to Date

- 5 rounds of community involvement
- Over 100 community meetings
- Over 500 attendees
- Over 1,000 responses to two Better Streets Plan surveys



Participants at the Better Streets Plan youth walking tour

### ADA Transition Plan Outreach

In coordination with the Better Streets Plan, the City conducted public outreach to provide input to the City's ADA Transition Plans for Curb Ramps and Sidewalks, which describe the City's priorities for installing accessible curb-ramps and barrier-free sidewalks. Five meetings were hosted by community organizations and directed at seniors and people with mobility, visual, or cognitive impairments. Participants were asked their priorities for installing these features.

The priority improvements identified by participants included:

- install new curb ramps instead of fixing existing (unless unsafe);
- focus on high-need areas throughout the city instead of moving district-by-district;
- fix sidewalks broken by tree roots;
- provide accessible wayfinding signage;
- remove obstructions such as low branches, parked cars, tables, merchant signs and displays, and bikes and skateboards;

For more information on the ADA Transition Plans for Curb Ramps and Sidewalks, see:

[http://www.sfgov.org/site/mod\\_index.asp?id=36604](http://www.sfgov.org/site/mod_index.asp?id=36604)







# Moving Forward

# 1.3

## FUTURE ACTIONS

The Better Streets Plan provides a comprehensive vision and guidelines for the design of the City's pedestrian realm. However, it is not enough for the City to simply adopt the Better Streets Plan. The City must also follow through to consistently use the Better Streets Plan and build projects that adhere to the Plan's vision.

To achieve this, the City should take a number of additional steps. Some of these steps are already funded and on-going; others have not yet begun and lack adequate funding.

### Improve the City's street design process

The Better Streets Plan process has illustrated how City agencies can work together in the design of streets. However, it has also highlighted the challenges of doing so

on an on-going basis. The Better Streets Team is working with the Controller's Office to study the City's existing street design and maintenance process and make recommendations for its improvement. See the Controller's Office report, available at [www.sfbetterstreets.org](http://www.sfbetterstreets.org).

### Develop a Better Streets Plan user guide and interactive website

The City should create a user-friendly guide and website to easily communicate the relevant guidelines, permits and resources in one place to anyone proposing to make changes to the public right-of-way. The Better Streets Plan is a 'living document' and will be amended over time to reflect new thinking. The user guide and website would be updated accordingly, such that there is a single, comprehensive location for information about making street changes.

## ➔ Moving Forward: Summary

- Improve the City's street design process
- Develop Better Streets Plan user guide and website
- Develop implementation and funding framework
- Develop additional technical plans (street and pedestrian lighting, street furnishings, roadway design manual)





### Develop a funding and implementation program

Using information from on-going planning efforts, long-range plans, and capital projects, the City should coordinate among agencies to develop a set of priorities, specific implementation projects, and a long-term capital plan for street improvements, recognizing opportunities to combine funding sources into single projects for cost efficiency and completeness. The City should identify existing and potential new funding sources for pedestrian realm improvements.

### Develop additional technical guidance

The Better Streets Plan provides high-level guidance on how to design and layout the pedestrian realm. These guidelines complement existing City street design guidance, such as the Bicycle Plan design guidelines, Stormwater Design Guidelines, and Traffic Calming Guidelines. City guidelines that are not consistent with the Better Streets Plan should be amended to make them consistent.

In addition, the City should create guidelines for areas of the right-of-way that are not covered by the Better Streets Plan or other existing guidelines, including the development of:

- street furnishings palette;
- street and pedestrian lighting plan;
- roadway design manual.

### PAYING FOR BETTER STREETS IMPROVEMENTS

The Better Streets Plan's premise is that streets and sidewalks must be improved comprehensively to meet a variety of functions, in a way that offers a safe and pleasant experience for everyone using them. To achieve this in any significant and efficient measure requires an agreed upon plan, which depends for its success and implementation on the full range of partners who make changes to the street: individuals and community groups through their personal interests in improving their immediate streetscapes, the development community as a condition of their right to build, the City through its capital improvement program, and the integrated actions of utilities working in the public realm.

For those streetscape improvements initiated by the City, the holistic improvements envisioned in the Better Streets Plan will require significant amounts of funding to build and maintain. Despite record investments in capital improvements proposed over the next decade, the City has an estimated \$885 million of deferred capital improvements required to merely maintain the city's streets and right-of-ways in their current condition. Funding this backlog alone would require more than doubling this historic investment and would only bring our infrastructure to current standards, not the significantly higher standards envisioned within this document.

Complete streetscape improvements currently cost several million dollars per block to construct. For publicly funded projects, funding sources for these improvements (including transportation sales tax funds and federal and state grant sources) are limited. This means the City can only improve a select number of streets with Better Streets-type improvements each year at current funding levels. (Private developers and community members may also build or improve streets, constituting a significant source of streetscape improvements.)

Given limited capital funding, this may require significant trade-offs and decision points: should there be fewer projects with a more complete set of improvements, or a greater number with fewer improvements per street? Should a project cross an entire corridor, or just a few blocks? Which streetscape elements or corridors should be prioritized? The Better Streets Plan posits that street improvements should be made holistically, such that improvements have a greater impact and capital and operating efficiencies can be realized—however, it is important to note the trade-offs that this entails given funding limitations.

As a next step to the Better Streets Plan, the City should develop a recommended program for implementing the envisioned improvements. That program must be integrated into the city's ten-year capital plan so that it can be appropriately prioritized and adequately coordinated within the city's larger capital planning program. Moreover, the operating budget impacts of any capital improvements must be identified and funded prior to implementation. Securing sustained maintenance funding is essential to ensuring the viability and durability of any improvements such as those contemplated in this document.

The City must address funding and set realistic priorities as part of its capital planning process for what can be accomplished. The need for higher funding levels will pose a challenge. Currently available resources and funding levels will greatly limit our ability to accomplish more than a fraction of the desired improvements in the foreseeable future.

But it is important to get started. Other thriving cities have realized that prosperity depends on safe, convenient, and pleasant ways of getting about—and are further along on improving their public realm. San Francisco's future is tied to functional, attractive streets and sidewalks. The Better Streets Plan is a key first step in this important journey.



## → Roadway Standards: Designing the Entire Right-of-Way

The pedestrian character and quality of place for a given street is determined as much by the design of the roadway between the curbs as by what happens on the sidewalk. Factors such as numbers of lanes, lane widths, design and posted speeds, number of directions (one-way or two-way), and how the roadway is split among different travel modes (transit, bicycles, vehicles) exert a great influence on pedestrian safety and quality. There are many opportunities across the City to enhance the pedestrian realm by putting streets on a ‘road diet’: removing vehicle travel lanes and increasing sidewalk space, bicycle and transit lanes, and other amenities.

The Better Streets Plan does not directly address these roadway design issues, focusing instead on the pedestrian realm of sidewalks and crossings. It is an important step that will lay the groundwork for future plans and projects. It represents a manageable piece to begin to bring the multitude of City agencies, community members, private developers, and advocates together to begin the work of improving the City’s streets, and to provide a comprehensive resource on streetscape and pedestrian design that the city currently lacks.

Although they are complex subjects in themselves, the policies and guidelines in the BSP are likely to have greater public acceptance, present fewer conflicts among various City agencies, and be generally simpler than the pieces that may follow – politically and technically difficult decisions about street classifications, levels of service, or assigning roadway right-of-way among various travel modes. This plan is intended to begin the public dialogue and create the strong interagency and public relationships to make subsequent steps more feasible.

The areas of the street covered by the Better Streets Plan can be shaped by individual community members or developers, who have rights and obligations tied to management of the sidewalk realm. The Better Streets Plan focuses on this realm such that the basic amenities (trees, lights,

curb-cuts, paving materials, path clearances) we value collectively are supported and maintained by the individual interests who have some independent control over them.

### NEXT STEPS

For any holistic re-design of a complete street from property line to property line, the Better Streets Plan tools must be coupled with thoughtful decisions on what happens between the curbs. The Better Streets Plan identifies several potential next steps to complete the City’s thinking on street design through to encompass the entire street. These projects will require significant commitment, time and budget from the City. Funding has not yet been identified, but the City recognizes that these are necessary steps to achieve a world-class street system.

Potential next steps may include:

- create a roadway design manual (City policies for street classifications, roadway dimensions, and right-of-way allocation);
- update of the Transportation Element of the San Francisco General Plan (and associated roadway networks and classifications);
- update to Traffic Calming Guidelines (including guidelines and/or standard plans for features not specifically called-out in the Better Streets Plan); and
- reform transportation analysis in environmental review to consider measures that prioritize transit, bicycles, and pedestrians.

By taking these steps, the City can create a comprehensive set of street design guidance that considers the entire right-of-way from property line to property line and prioritizes pedestrian, bicycle, and transit over auto travel per the City’s ‘Transit-First Policy.’





# CHAPTER

# 20



CHAPTER

# 2.0

CONTEXT

- 2.1 Existing Conditions
- 2.2 Regulatory Context
- 2.3 Existing City Efforts

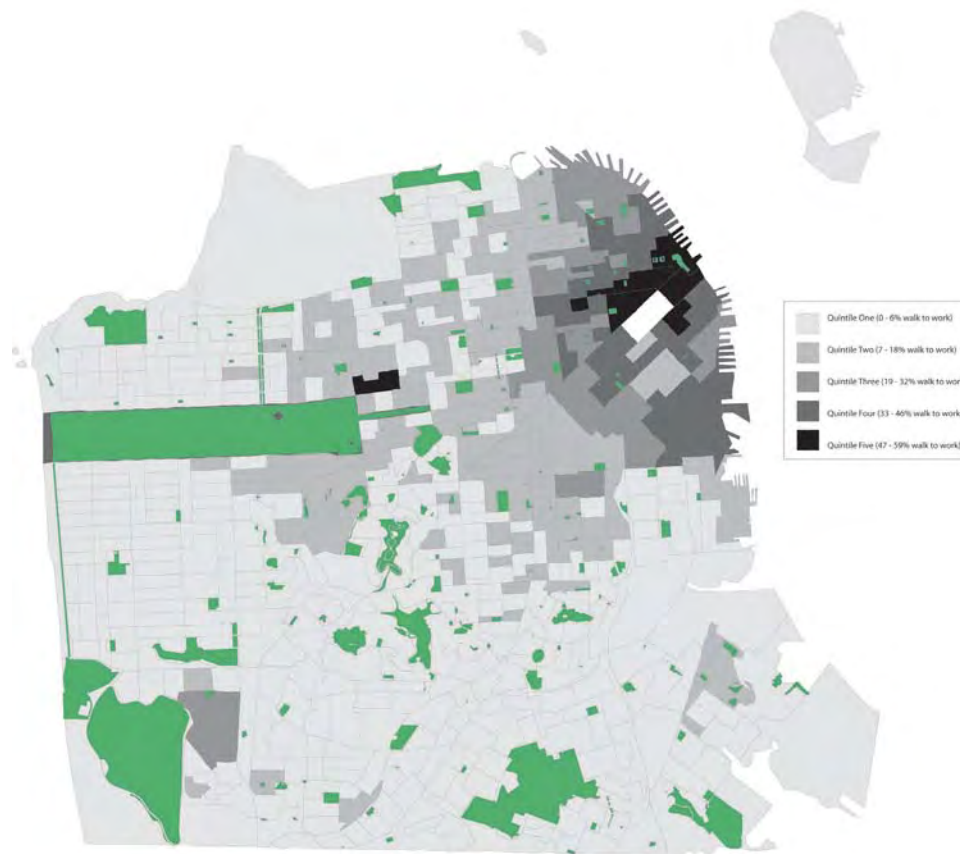
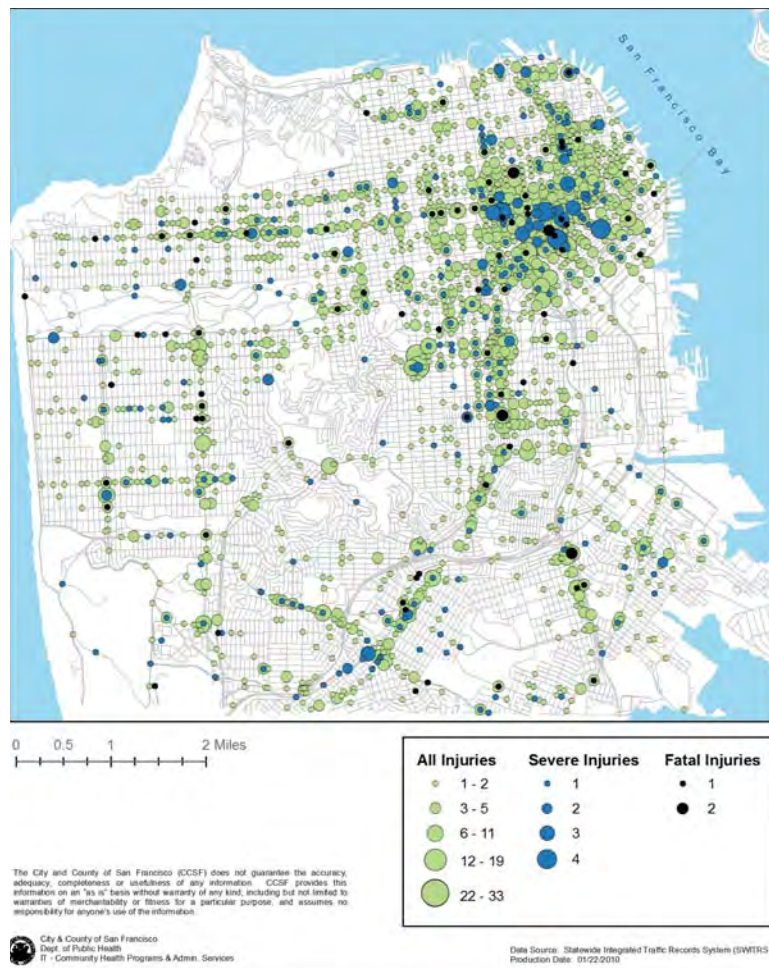
# CONTEXT

San Francisco is a walker's city – a dense mix of uses, short blocks, and small streets combine to make a convenient and desirable walking environment. However, existing conditions could still be improved to promote a safer and more comfortable pedestrian realm.

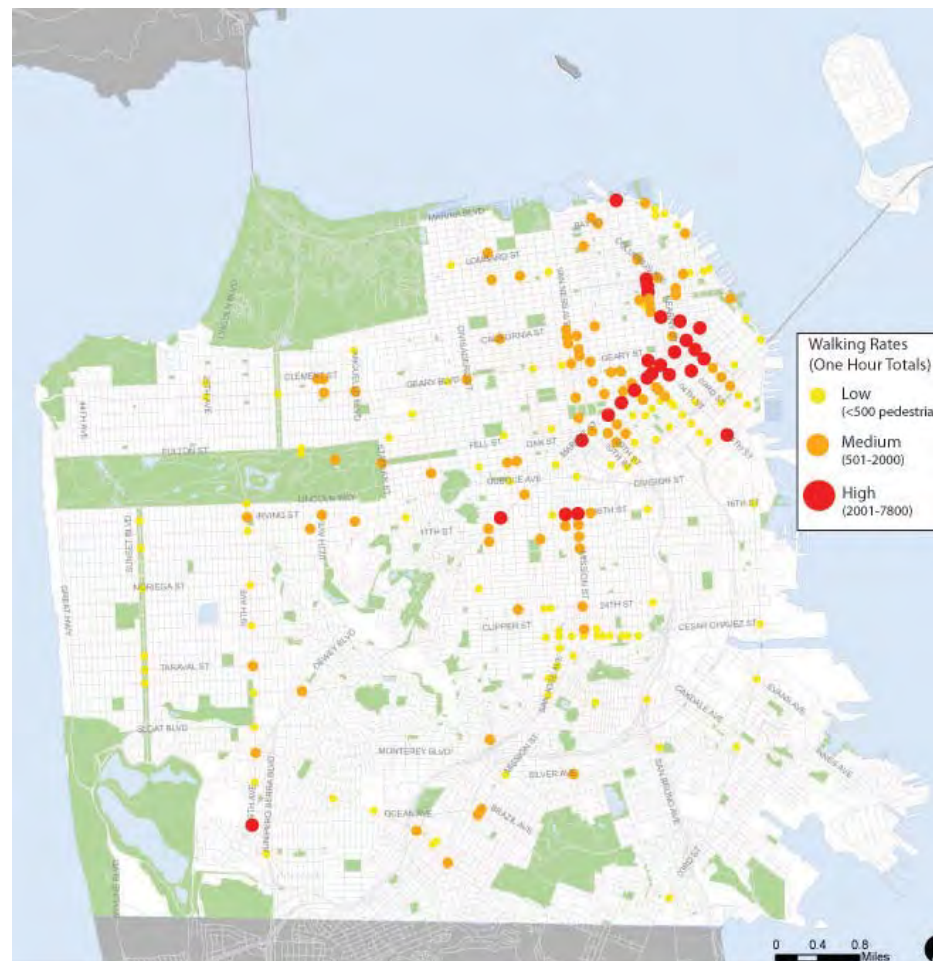


**FIGURE 2.1**  
**PEDESTRIAN INJURIES CITYWIDE**  
**2004-2008**

Source: Statewide Integrated Traffic Records System (SWITRS)



**FIGURE 2.2**  
**PERCENTAGE (BY QUINTILE)**  
**OF POPULATION THAT WALKS**  
**TO WORK**  
 Source: US Census, 2000



**FIGURE 2.3**  
**VOLUME OF PEDESTRIANS**  
**PER HOUR AT SELECTED**  
**INTERSECTIONS**  
 Source: SFMTA Traffic Counts



# Existing Conditions

## 2.1

### PEDESTRIAN CONDITIONS

Walking plays a major role in San Francisco's transportation system. Each day, 4.5 million transportation trips are made in San Francisco; of these approximately 890,000 (20%) are walking trips. An additional 780,000 trips (17%) are made on transit, most of which include walking at the beginning and end of each trip. (See Table 2.1)

Most streets in San Francisco include basic pedestrian infrastructure such as sidewalks and marked crosswalks. As some formerly industrial areas transition to commercial and housing uses, gaps in the basic pedestrian network are being filled in.

Block size and intersection density (the number of intersections per area) greatly affect the ease and convenience of walking in San Francisco. Shorter blocks in areas such as Downtown and Chinatown provide more choices and direct routes for pedestrians. In other neighborhoods, such as the Mission District or Hayes Valley, a network of alleys helps break up larger blocks to provide pedestrian connections. In yet other areas, such as SoMa, blocks are approximately four times longer than typical downtown blocks, creating less frequent or direct pedestrian connections.



► Embarcadero Plaza crosswalk



### Major pedestrian activity generators

Pedestrian activity in San Francisco is clustered in locations where activity generators such as commercial corridors, transit facilities, and major institutions are concentrated.

Observed walking rates are collected by SFMTA at selected intersections. Data for citywide walking rates comes from the US Census journey to work survey, which asks respondents to name the mode of transportation they most often use to get to work. This data does not provide the full spectrum of transportation trips and only includes the mode most often used to get to work, so it does not provide a comprehensive picture of transportation choice across the City. However, the journey to work data does show the areas of San Francisco, most notably Downtown, where walking rates to work are most concentrated.

### SAN FRANCISCO MODE SPLIT FOR ALL TRIPS, 2000

Source: San Francisco County Transportation Authority

Auto	2,809,000	62%
Transit	777,000	17%
Walk	892,000	20%
Bike	40,000	1%
TOTAL	4,518,000	100%

### Collision Patterns

Data on pedestrian collisions in San Francisco comes from two sources: the Statewide Integrated Traffic Records System (SWITRS) and the PedSafe study, conducted by UC Berkeley researchers and the SFMTA. The SWITRS data, compiled by the California Highway Patrol, is based on San Francisco Police Department traffic collision reports, while the PedSafe study analyzed hospital discharge records in addition to police reports to include pedestrian injuries for collisions that were not reported to the police.

In recent years, reported pedestrian injury collisions have decreased from approximately 900 to 1000 per year in the 1990's to 700 to 800 from 2006 to 2008. Additional

improvements are necessary, but the overall decline in pedestrian collision totals over the past 15 years is encouraging. The number of pedestrian fatal collisions decreased to 12 in 2008, which was the lowest number in the past decade, following a spike in 2007 to 21 pedestrian fatalities. In general, injury collisions are a more reliable indicator of collision trends over time because fatal collisions, being rarer events, are more subject to random fluctuations.

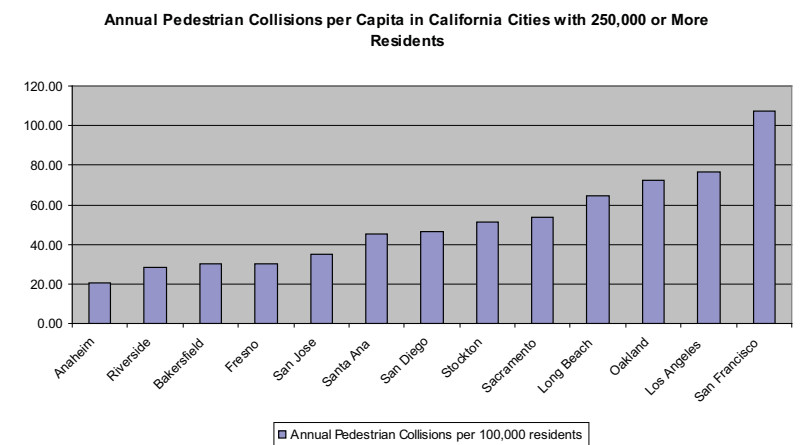
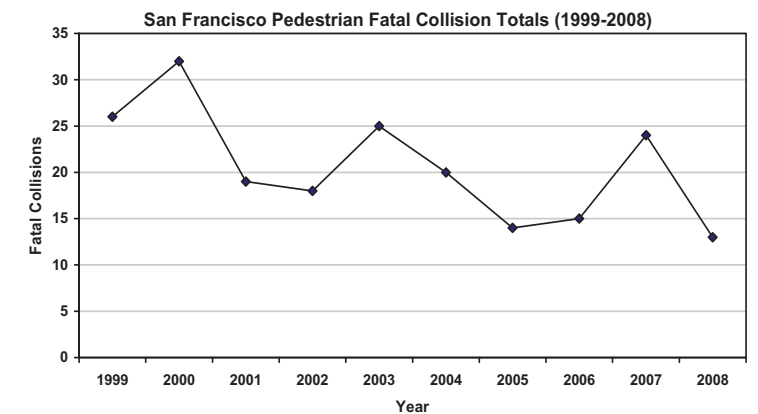
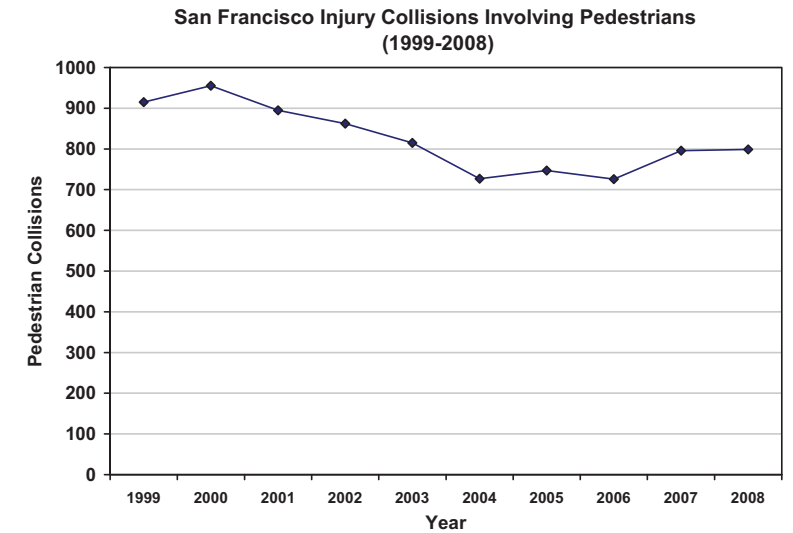
According to the PedSafe study, both fatal and non-fatal injuries often occur at intersections with a traffic signal. According to 2001-2005 data from the 89 intersections with the most pedestrian collisions in San Francisco, all 17 fatal collisions occurred at signalized intersections. The majority of pedestrian injury collisions also occurred at intersections with a traffic signal, as shown in Figure 2.10.

Pedestrian-injury collisions in San Francisco are highly concentrated in clusters. The PedSafe Phase I Report identified seven higher-risk zones based on injury density and severity and the potential to benefit from modest pedestrian injury countermeasures in the absence of other major interventions for pedestrian safety. The seven zones are: SoMa West; North Mission; Chinatown/North Beach; Outer Mission Street; Geary Blvd./Cathedral Hill/Japantown; Geary Blvd./Richmond; and Upper Market Street. Based on the San Francisco 2008 Collision Report, the four locations with the most pedestrian collisions between 2006 and 2008 were: 6th and Market Streets; 6th and Howard Streets; Golden Gate and Jones Streets; and 6th and Mission Streets.

In San Francisco, senior pedestrians are at a higher risk of dying in collisions than any other age group. Seniors are most often hit by vehicles at signalized intersections and often involve drivers making a left turn. Unlike national and statewide trends, children are not overrepresented in pedestrian collisions in San Francisco.

In per capita terms, San Francisco has a high number of pedestrian injuries and collisions. However, this is largely a function of the fact that lots of people walk in San Francisco, and does not mean that San Francisco is a particularly dangerous place to walk; in fact, the opposite is

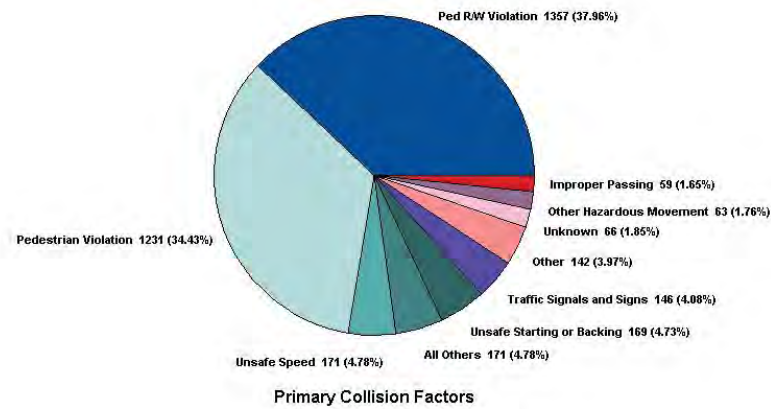
FIGURES 2.3 - 2.5



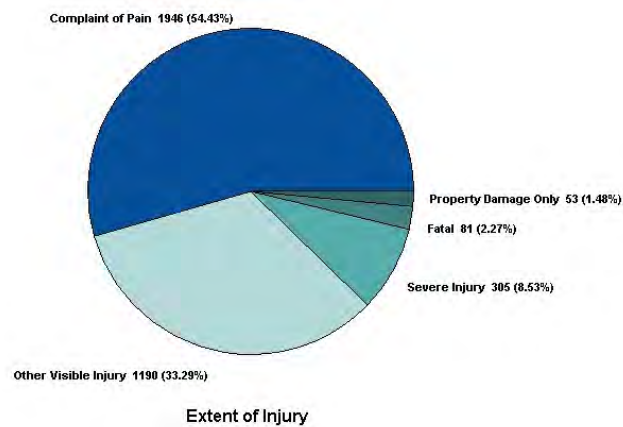
Source: San Francisco 2008 Collisions Report, SFMTA



FIGURES 2.7 - 2.9



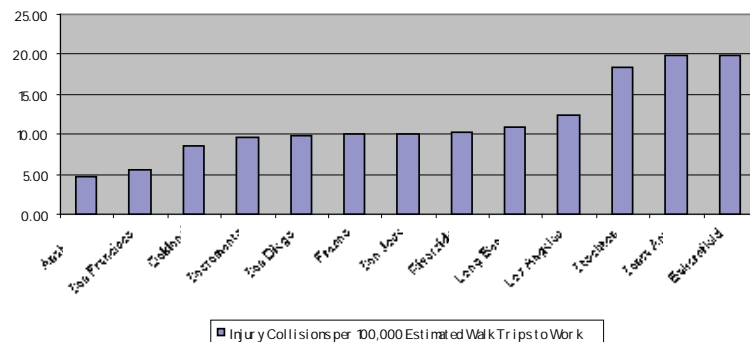
PRIMARY COLLISION FACTORS 2002-2006



EXTENT OF PEDESTRIAN INJURY 2002-2006

Source: SFMTA

ESTIMATED PEDESTRIAN EXPOSURE RATE FOR CALIFORNIA CITIES WITH 250,000 OR MORE RESIDENTS



true. (Per capita collisions tell very little about a City's relative safety for walking. Very few pedestrians are injured on freeways, but this does not make them safe places to walk.)

Among the 13 cities in California with a population over 250,000, San Francisco had the most pedestrian injuries and collisions per capita in 2007, with 822. However, if the number of people who walked to work in these cities in 2007 is used instead of population to create a collision rate per pedestrian, San Francisco ranks 12th out of 13, indicating that San Francisco's collision rate per pedestrian is very low relative to other major cities in California.

Pedestrian collisions are caused by a number of factors. However, most injury collisions are attributable to either motorists who violate pedestrian right-of-way (pedestrian right-of-way violations) or pedestrians who violate the vehicle code (pedestrian violations).

In addition to human costs, pedestrian collisions are a major expense to the city. A recent study by the UCSF San Francisco Injury Center found that the total cost of pedestrian injury at San Francisco General Hospital averaged about \$15 million/year between 2004 and 2009.<sup>1</sup> This does not even include health care costs related to chronic diseases caused by lack of physical activity.

### Pedestrian Surveys

San Francisco has historically not done comprehensive studies of how pedestrians perceive the quality of the pedestrian environment. The majority of data in San Francisco focuses on either pedestrian safety statistics, or physical conditions of existing infrastructure. However, the City is beginning to incorporate surveys of pedestrian perception into its data collection, which will give a more complete picture of pedestrian conditions.

## CONDITION OF EXISTING INFRASTRUCTURE

### Pedestrian Signals

The SFMTA is working to install pedestrian countdown signals at all traffic signals in the City. As of this draft

approximately 740 of 1155 signalized intersections (65%) in San Francisco have pedestrian countdown signals for all crosswalks. Another 50 intersections are programmed to receive countdown signals over the next few years. Of the remaining 365 intersections, 183 have countdown signals for some of the crosswalks and 182 have no countdown signals at all.

FIGURE 2.10  
TRAFFIC CONTROL FOR PEDESTRIAN INJURY COLLISIONS

Top 89 Intersections in San Francisco, 2001-2005

YEAR / CONTROL	SIGNAL	STOP	OTHER	GRAND TOTAL
2001	89	1	5	95
2002	109		3	112
2003	93		8	101
2004	105		1	106
2005	102		5	107
<b>Grand Total</b>	<b>498</b>	<b>1</b>	<b>22</b>	<b>521</b>

Source: San Francisco PedSafe Study

### Sidewalks, Stairs and Paths

Prior to 2007, the City of San Francisco relied primarily on public complaints to identify needed sidewalk repairs. In 2007, the Department of Public Works (DPW) instituted the Sidewalk Inspection and Repair Program (SIRP) to proactively identify and make needed sidewalk repairs. The SIRP inspects all sidewalks on a 25-year cycle, prioritized by pedestrian usage. The SIRP informs all responsible parties (both public and private property owners) of sidewalk damage, and DPW then coordinates repairs to make repairs in a timely and efficient manner.

### Curb Ramps

Curb ramps were first installed in San Francisco in the early 1970's. Since that time, DPW and other public and private entities have installed numerous curb ramps across the city. In addition to funding dedicated specifically to curb ramp construction, street changes such as curb changes, re-paving, or new construction typically trigger a requirement to construct curb ramps.

<sup>1</sup> Cost of Auto Versus Pedestrian Injuries, San Francisco, 2004-2008; R. Dicker, M.D. et. al., San Francisco Injury Center, March 2010



The City has approximately 7,200 intersections. DPW policy is to build one curb ramp at each end of each crosswalk. However, due to traffic considerations and to topographical or other physical and legal constraints, two curb ramps are not always feasible at each street corner. The main barrier to installing two ramps per corner is the cost to construct new catch basins and utility relocation. As a result, the citywide average is 1.82 potential curb ramp locations per corner.

To assess the location and condition of the City's existing curb ramps and determine locations where new curb ramps should be installed, DPW created a detailed curb ramp database based on surveys of more than 29,000 intersections. This database identified 21,300 street corners with curbs in need of reconstruction or improvement, and 1,000 street corners where no ramp is feasible. An additional 17,000 intersections have not yet been surveyed.

### Street Trees

There are an estimated 106,000 street trees on public rights-of-way in San Francisco. Of these, approximately 26,000 are maintained by DPW Bureau of Urban Forestry. The remaining trees are maintained by private property owners in accordance with the Public Works Code. The City's recent "Clean and Green Initiative" seeks to plant an additional 5,000 trees every year for the next five years, including trees both on private land and in the public right-of-way.

DPW tracks the maintenance or mortality of individual DPW-maintained street trees, but not privately-maintained street trees (trees on streets that are not DPW-maintained streets). DPW has a goal of pruning street trees every three years; however, due to funding limitations trees are typically pruned every seven years.

According to the 2005 City Survey, performed by the Controller's Office, 59% of residents reported that there are "not enough" trees citywide while 52% said the number of trees in their neighborhood was "about right."

### Street Lighting

There are approximately 43,000 street lights in San Francisco. Of these, approximately 24,000 are managed and maintained by the SFPUC, while approximately 19,000 are maintained by PG&E. The SFPUC pays PG&E to maintain its street lights. Other departments and agencies including MUNI, DPW, Recreation and Park, the Port of San Francisco and CalTrans also maintain a small number of street and pedestrian lights.

The SFPUC estimates that a more comprehensive and effective maintenance program would require on the order of \$4 to 5 million per year over the next 5 years; however, its FY09/10 funding for street light maintenance was only \$2.4 million. In FY09/10, the SFPUC had a capital improvement budget of \$3.6 million for street lights.

In 2007, the Streetlight Management Program Study recommended that the "City should develop a Street Lighting Policy that will support the City's goals for livable neighborhoods and urban development, ensure appropriate lighting levels for safety and comfort on public streets and sidewalks, and help create a system that is cost efficient, easy to operate and maintain."

### Site Furnishings

The City of San Francisco does not currently keep records on the maintenance conditions of street furnishings such as benches. The City does not currently have a palette of accepted street furnishings; DPW is currently working on developing such a palette.

### Stormwater Infrastructure

The majority of San Francisco (90%) is served by a combined sewer system, which carries both sanitary effluent and stormwater in the same set of pipes. The combined effluent is conveyed to sewage treatment facilities where it is treated to secondary standards, then discharged to the Bay and Ocean. Under most circumstances, the combined system allows for higher levels of stormwater treatment than is provided by conventional separate systems.

However, when the capacity of the system is overwhelmed by large storm events, localized flooding and combined sewer overflows (CSOs) can occur. In the event of a CSO, the system discharges a mixture of partially treated sanitary and stormwater effluent to receiving water bodies. While these discharges are highly diluted (typically consisting of roughly 6% sewage and 94% stormwater), they can cause public health hazards and lead to beach closures. The SFPUC's National Pollutant Discharge Elimination System (NPDES) permit, required under the Clean Water Act, sets design goals for the allowable number of CSOs per year, on average, based on location.

Approximately 10% of the City is served by separate storm sewer systems or is lacking stormwater infrastructure; in most of these areas stormwater flows directly to receiving waters without treatment.

San Francisco's first 250 miles of sewers were built in the late 1800s; by 1935 almost two thirds of today's system had been installed. Sewers typically last from 50 to 100 years, so large portions of the City's pipes have exceeded their expected lifespan.

▼ Market Street





# Regulatory Context

## 2.2

Federal, state and local policies guide the design and implementation of pedestrian and streetscape elements. The federal Americans with Disabilities Act (ADA) provides guidelines for accessibility of elements such as sidewalks and curb ramps. Traffic control devices and geometrical design follow the standards set forth in the California Manual of Uniform Traffic Control Devices (MUTCD) and the American Association of State Highway and Transportation Officials (AASHTO) Green Book. Stormwater regulations are set primarily by the federal Clean Water Act. All projects that propose physical changes must receive clearance under the California Environmental Quality Act (CEQA), and the National Environmental Policy Act (NEPA) if the project involves federal funds or jurisdiction. Additionally, a number of existing local regulations provide guidance on the prioritization and design of pedestrian facilities in San Francisco.

### FEDERAL AND STATE POLICIES

#### Accessibility

All new construction, additions, and alteration to public rights-of-way must be accessible and usable by individuals with disabilities per federal, state and local regulations. Current regulations focus primarily on lots and buildings, and have significant gaps in scope and technical requirements for design and construction of accessible elements within the public right-of-way.

The prevailing accessibility standard, the ADA Accessibility Guidelines (ADAAG), currently scopes accessibility requirements within sites and not in the public right-of-way. ADA Title II, which is applicable to state and local governments, contains requirements for curb ramps, but lacks clarity on specific accessibility guidelines for other right-of-way elements.





The US Access Board, the Federal agency responsible for developing accessibility guidelines, is in the process of redesigning ADAAG. When completed, the new guidelines propose to include Public Rights-of-Way Accessibility Guidelines (PROWAG). As of this draft, the PROWAG has not been completed, and will require several years of further development and approval.

PROWAG is oriented to new construction. It does not provide a clear set of guidance for conditions where "...other existing physical or site constraints prohibit modification or addition of elements, spaces, or features which are in full and strict compliance with the minimum requirements for new construction and which are necessary to provide accessibility". PROWAG should be considered a "best practice" and not a strict, formal requirement.

In San Francisco, Department of Public Works (DPW) standard plans set forth local requirements that incorporate accessibility guidelines for commonly implemented infrastructure improvements, such as curb ramps.

Appendix D (Summary of Accessibility Guidelines) contains requirements and best practices for design of accessible components in the public right-of-way.

### Transportation

**MUTCD** The MUTCD provides uniform standards, guidance, and specifications for the placement, construction, and maintenance of all traffic control devices including traffic signals (Part 7), traffic signs (Part 2), and street markings (Part 3).

**AASHTO Green Book** AASHTO has developed "A Policy on Geometric Design of Highways and Streets," known as the "AASHTO Green Book." The guidance supplied in the policy is based on established practices and supplemented by recent research. The intent of the policy is to provide guidance to the designer by referencing a recommended range of values for critical street dimensions. The guidelines are intended to provide safety, comfort, convenience, and operational efficiency.

**California Vehicle Code** The California Vehicle Code (CVC) describes the responsibilities of pedestrians when crossing the street, or walking along a street on a sidewalk. The CVC also addresses the roles and responsibilities of motorists in relationship to pedestrians. California, like most other states, requires both pedestrians and drivers to exercise due care.

The CVC states that drivers must yield the right-of-way to a pedestrian crossing the roadway in a marked or unmarked crosswalk. It does not prohibit pedestrians from crossing roadways at places other than crosswalks, except between adjacent intersections controlled by traffic signals or police officers. Local authorities may adopt ordinances prohibiting pedestrians from crossing streets outside crosswalks. For signalized intersections, the CVC states that the pedestrian may cross with a green light at any marked or unmarked crosswalk unless expressly prohibited. The pedestrian shall yield the right-of-way to vehicles lawfully within the intersection at the time the signal changed.

According to the CVC, "it is the policy of the State of California that safe and convenient pedestrian travel and access, whether by foot, wheelchair, walker, or stroller, be provided to the residents of the state." The code also states that it is the intent of the Legislature that all government levels to work to provide safe, convenient passage for pedestrians on or across all streets and highways, increase levels of walking, and reduce pedestrian fatalities and injuries.

### Stormwater

In 1972, the US Congress passed the Clean Water Act to regulate the discharge of pollutants to receiving waters such as oceans, bays, rivers, and lakes. The California State Water Resources Control Board (SWRCB) serves as the implementing agency for these regulations in California.

Most stormwater in San Francisco is collected in a combined stormwater and sanitary sewer system and treated prior to discharge to San Francisco Bay or the Pacific Ocean. The remainder is collected in a separate stormwater

sewer system. Ownership of the separate system is divided between two City agencies: the Port of San Francisco for areas along the City waterfront, and the SFPUC for all other areas within the City's jurisdiction.

Since 2004, the discharge of stormwater from the separate stormwater sewer system has been covered by a statewide general permit for small municipal separate storm sewer systems (MS4), issued by the San Francisco Bay Regional Water Quality Control Board. As a requirement of the permit, the Port and SFPUC are required to develop detailed stormwater management plans (SWMPs) outlining implementation of various control measures required under the statewide general permit. The SWMPs set guidelines for incorporating design features into new development and redevelopment projects to permanently control stormwater runoff in compliance with the Clean Water Act. To help new development develop SWMPs, the Port and SFPUC have developed the San Francisco Stormwater Design Guidelines, discussed in this section and in Section 6.2.

### Environment

In 1970, the California legislature passed the California Environmental Quality Act (CEQA). CEQA is intended to ensure that projects or policies that may result in changes to the physical environment fully analyze any potential impacts to the physical environment, including impacts on visual quality, transportation, biological resources, historical resources, and other categories. Plans or projects that may result in physical changes must receive CEQA clearance in order to proceed with implementation. Projects with Federal funding or jurisdiction must additionally undergo analysis under the National Environmental Protection Act (NEPA), the Federal equivalent of CEQA.

In San Francisco, most CEQA review is carried out by the Planning Department.



## CITY OF SAN FRANCISCO POLICIES

Local street design regulations are found in a number of existing City documents. Together, these documents require that streets be designed for all types of transportation, particularly walking, bicycling, and transit, and set forth design policies and guidelines to implement that goal.

Many of these plans and codes have been updated as part of the adoption this plan.

### The San Francisco General Plan

The San Francisco General Plan provides policies to guide future City growth; all other City regulations must be consistent with General Plan policies. Two chapters of the General Plan are particularly germane to design of streets – the Urban Design Element and the Transportation Element. The Open Space and Recreation Element also contains policies to encourage the use of streets to provide public space.

### The Better Streets Policy

San Francisco Administrative Code Section 98.1, known as the ‘Better Streets Policy,’ states that streets are for all types of transportation, particularly walking and transit, and requires City agencies to coordinate the planning, design and use of public rights-of-way to carry out the vision for streets contained in the policy. The Better Streets Policy was adopted in 2006. See Appendix A for full text.

### Transit-First Policy

The Board of Supervisors initially adopted the ‘Transit-First Policy’ in 1973 in response to the growing challenge of automobile traffic congestion. In 1999, San Francisco voters approved Proposition E, which moved the Transit-First Policy to the City Charter to strengthen the policy and make it the City’s primary transportation policy. The Transit-First Policy states that the City should prioritize street improvements that enhance travel by public transit, by bicycle and on foot as an attractive alternative to travel by private automobile. See Appendix B for full text.

### “Complete Streets” Policy

The “Complete Streets” Policy (Section 2.4.13 of the Public Works Code) directs the City to include pedestrian, bicycle, and streetscape improvements as part of any planning or construction in the public right-of-way. See Appendix C for full text.

### Area Plans

Area Plans, Master Plans, Redevelopment Plans, and Specific Plans include regulations for a specific geographic area of the City. Typically, area plans contain policies and guidelines relating to the design of streets in these particular areas, and may even recommend a specific palette of streetscape materials and plantings. Two area plans with citywide significance are the Downtown Streetscape Plan, adopted in 1995, which guides development of the downtown pedestrian network and the Waterfront Design and Access Element, adopted in 1997 as part of the Port’s Waterfront Land Use Plan, which guides the physical aspects of waterfront revitalization.

## ➔ Streetscape Maintenance: Rights and Responsibilities

Maintenance of public streets and sidewalks in San Francisco is split among various public agencies, utilities, and property owners.

### ROADWAYS

The roadway is generally maintained by DPW, including travel lanes and parking lanes. Catch basins are managed by the SFPUC, but maintained by DPW. Utility providers often excavate in the roadway to maintain or repair utility lines – utility providers are required to replace paving in-kind per the Public Works Code (Article 2.4) and DPW Director’s Order #176,707 (Section 12.4.B).

### SIDEWALKS

On most streets in San Francisco, sidewalk maintenance and repair is the responsibility of the fronting property owner. Resources are available through DPW’s Sidewalk Inspection and Repair Program (SIRP) ([http://www.sfgov.org/site/sfdpw\\_page.asp?id=89724](http://www.sfgov.org/site/sfdpw_page.asp?id=89724)), which enables property owners to use DPW contractors to repair

sidewalks. The Sidewalk Landscape Permit is also available through DPW, which enables property owners to replace portions of the sidewalk in front of their property with landscaping, which may preclude the need to repair portions of broken sidewalk ([http://www.sfgov.org/site/sfdpw\\_index.asp?id=42766](http://www.sfgov.org/site/sfdpw_index.asp?id=42766)).

### UTILITIES

Utility main lines are the maintenance responsibility of the utility provider. Utility laterals (which connect individual lots to the main line) are typically the responsibility of the property owner to maintain or repair.

### STREET TREES AND LANDSCAPING

On most streets in San Francisco, maintenance of trees and landscaping on the sidewalk is the responsibility of the fronting property owner. Property owners and the City often partner with the non-profit organization Friends of the Urban Forest to plant and maintain trees. DPW is generally responsible for trees and landscaping in medians.

On some streets, DPW is responsible for maintenance of street trees on the sidewalk. See [http://www.sfgov.org/site/sfdpw\\_index.asp?id=33189](http://www.sfgov.org/site/sfdpw_index.asp?id=33189)

### STREETLIGHTS

Streetlights are managed and maintained by a variety of agencies, chiefly the SFPUC and PG+E. Pedestrian lights are typically not managed by the utility providers, and, where provided, are typically maintained by DPW.

### SITE FURNISHINGS

Many streetscape elements, such as the pedestal newsracks, kiosks, sidewalk restrooms, and Muni bus shelters, are provided and maintained by private companies as part of advertising contracts with the city. Other site furnishings are maintained by DPW (such as trash receptacles), or SFMTA (such as bike racks or bollards); yet others are maintained by fronting property owners.



### City Codes

The City's various codes include specific regulations to implement the policies in the General Plan, Area Plans, and other policy documents.

#### *Administrative Code*

As previously mentioned, Chapter 98 of the San Francisco Administrative Code includes the Better Streets Policy. In addition, Chapter 25 of the code contains several sections related to streetlights.

#### *Building Code*

San Francisco has five regulatory codes that are sometimes collectively referred to as the “building code:” the Building Code proper and the Electrical, Housing, Mechanical, and Plumbing codes. Together, these codes include a small number of policies related to how buildings interface with the public right-of-way.

#### *City Charter*

The City Charter of the City and County of San Francisco, which serves as the fundamental law of the City and County, includes the Transit-First Policy, described above.

#### *Fire Code*

The City's Fire Code has one section that is highly relevant to streetscape design. Section 7.01 (found under part IX, “Appendices”) establishes requirements for street sizes to facilitate emergency equipment access.

#### *Planning Code*

The San Francisco Planning Code includes detailed regulations to implement the policies of the General Plan. It contains a number of regulations related to street design, including policies to control how private development impacts public streets and use of public streets, and requirements for provision of street trees and other sidewalk and pedestrian improvements.

#### *Public Works Code*

The San Francisco Public Works Code contains most of the local rules and regulations that are of relevance to streetscape design and maintenance.

#### *Transportation Code*

The City's Transportation Code is a compilation of local rules and regulations governing vehicle traffic.

### Departmental Standards and Guidelines

#### *DPW Director's Orders*

In addition to adopted plans and policies, the Department of Public Works issues Director's Orders, which set specific technical guidance for features such as curb ramps, streetlights, and sidewalks.

#### *DPW Standard Specifications and Plans*

DPW has developed standard specifications and plans for design and construction within San Francisco, including streetscape and pedestrian features such as curb ramps and traffic circles.

#### *SFMTA Traffic Calming Guidelines, Crosswalk Guidelines, and Pedestrian Signal Guidelines*

The SFMTA has developed guidelines to direct implementation of traffic calming measures in San Francisco. The guidelines are largely procedural, and also include a table describing which traffic calming measures are appropriate on particular street types. In addition, the SFMTA has developed guidelines to direct the placement and design of crosswalk markings and pedestrian signals. These guidelines are consistent with this plan, but provide greater technical detail.





# Existing City Efforts

## 2.3

### EXISTING CITY STREET DESIGN PROCESS

Design, construction and management of the pedestrian realm in San Francisco today is scattered across several different departments, agencies, private entities, and organizations. Though there are many good projects, results are inconsistent depending on the project sponsor, and the process can be expensive, time-consuming, and confusing.

As part of the Better Streets Plan effort, the City has commissioned the Controller's Office to review the City's existing street design process and make recommendations for its improvement (the "Better Streets Institutional Analysis"). This report was developed independently of this plan and was released in January 2010. The report is available at [www.sfbetterstreets.org](http://www.sfbetterstreets.org).

This section gives a brief overview of processes and responsibilities regarding street design in the City as it exists today.

#### Capital Planning

Street improvement projects are identified through the capital planning efforts of a variety of agencies, including SFMTA, DPW, SFPUC, SFCTA, the Planning Department, the Port, and the Redevelopment Agency. Each department or agency develops their own capital

plan based on their long term planning programs, community generated request, and opportunities to coordinate with other agencies' projects. Department capital plans are informed by the Congestion Management Program (CMP) which is developed and administered by the SFCTA.

Agencies and departments submit their budgets to the City's Capital Planning Program, housed in the City Administrator's office. This program reviews and analyzes infrastructure needs and facility conditions, evaluates capital project requests, and establishes financing strategies to meet the City's long- and short-term capital needs. Capital components of department budgets are incorporated into the City's ten-year Capital Plan upon the approval of the Capital Planning Committee. The Board of Supervisors adopts the Capital Plan annually.

Opportunities to more closely coordinate long-term capital planning efforts between agencies could result in cost savings and leveraging opportunities by identifying related projects early on in the planning stage.

#### Funding

Funding for street improvements is available from Federal, State, Regional, County and City sources. This section describes the major available existing sources of funding for street improvements.





Since 1991, the US Federal Highway bill, financed through gas tax revenues, has included programs for pedestrian safety and infrastructure. The current version of this act (Safe, Accountable, Flexible, Efficient Transportation Equity Act: A Legacy for Users – SAFETEA-LU), provides funding for street improvement programs such as Safe Routes to Schools. These funds are administered through State and Regional bodies. Congress is currently considering reauthorization for SAFETEA-LU.

The Bay Area region has created additional programs to fund transportation-related improvements. The regional planning organization for the nine-county Bay Area, the Metropolitan Transportation Commission (MTC), provides transportation funds through several programs, including Transportation for Livable Communities, the Lifeline Transportation Program, Safe Routes to Transit and Safe Routes to School. The Bay Area Air Quality Management District administers a program funded by a gas tax surcharge called the Transportation Fund for Clean Air.

In 2003, San Francisco voters approved Proposition K, which authorized the City to collect a one-half cent sales tax to fund a new 30-year Transportation Expenditure Plan. Proposition K funds are administered through the SFCTA, as are state Transportation Enhancement funds.

In 2006, California voters approved Propositions 1B and 1C, which authorized the issuance of general obligation bonds for transportation infrastructure and housing infrastructure, respectively. The SFMTA and DPW receive formula funds from the transportation infrastructure bond. Additional grants are available to fund infrastructure related to infill and transit-oriented housing development allocated through the housing infrastructure bond. The federal American Recovery and Reinvestment Act has also provided funding for street improvement projects.

The City and County of San Francisco also has a number of tools available to fund street improvement projects. Currently, a small amount of the City's General Fund supports street improvement projects. Developer fees, assessment districts (such as Mello-Roos Community

Facilities Districts), and tax-increment financing in redevelopment areas are all tools available to the City for future sources of street improvement revenue. Developer- and community-led projects also constitute a significant resource for street improvements with untapped potential.

Although there are a number of potential funding sources for streetscape and pedestrian improvements, the total is fairly insignificant compared to the level of need in the City today, and the City can only finance and build a handful of significant street improvement projects each year. Additional revenue sources must be sought to fully build the vision of the Better Streets Plan.

### Planning and Design

Street design may be done by any number of departments. DPW, SFMTA, the Planning Department, the San Francisco Redevelopment Agency, the SFPUC, and the Port of San Francisco all propose and design street improvements as part of on-going programs. Each of these agencies has a unique mission, and thus project proposals may differ greatly from one project to the next. In addition, private development sponsors often design streets (reviewed and approved by City agencies) as part of their development proposals. Community members and organizations may also plan for and design street improvements.

Typically, agencies coordinate with one another on street improvement projects, through technical advisory committees, on-going formal meeting bodies, or informal coordination. There are currently few formal structures for comprehensive interagency coordination of street improvements, particularly at the early planning stages.

### Regulation and Permitting

As with planning and design, many agencies are responsible for permitting of public realm improvements. Generally speaking, DPW's Bureau of Street Use and Mapping is responsible for regulating and permitting street and sidewalk use, SFMTA is responsible for traffic and parking changes, and the SFPUC regulates stormwater run-off and is responsible for street light design and specifications.

Street improvement projects typically require approvals or recommendations at least from DPW, SFMTA, Planning, the Arts Commission, and TASC (an interdepartmental body) before going to the Board of Supervisors and/or the SFMTA Board for approval.

In many cases, acquiring simple permits may be a burdensome and expensive endeavor, discouraging community members from making streetscape improvements and delaying or adding expense to development projects.

### Maintenance and Repair

Street maintenance responsibility is shared between City agencies and property owners. On most streets, property owners are responsible for sidewalk, driveway, street tree, and landscape maintenance (DPW has responsibility on the remainder of streets). Most street repair and maintenance from the City side is carried out by DPW. This includes day to day maintenance such as street sweeping, less frequent maintenance such as catch basin cleaning, and repairs such as re-paving. One notable exception is street lighting: the SFPUC owns most street light poles and is responsible for maintaining them.

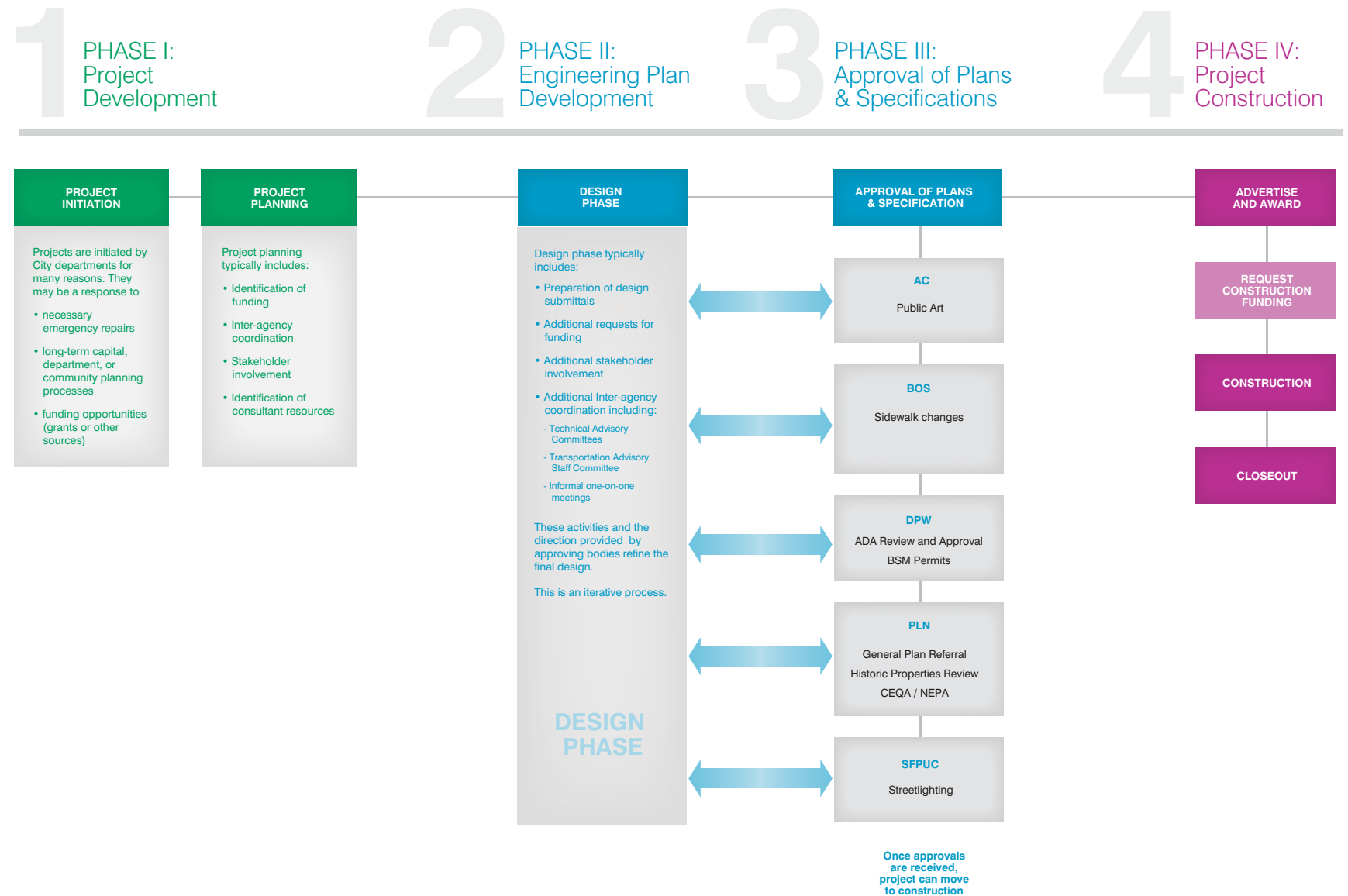
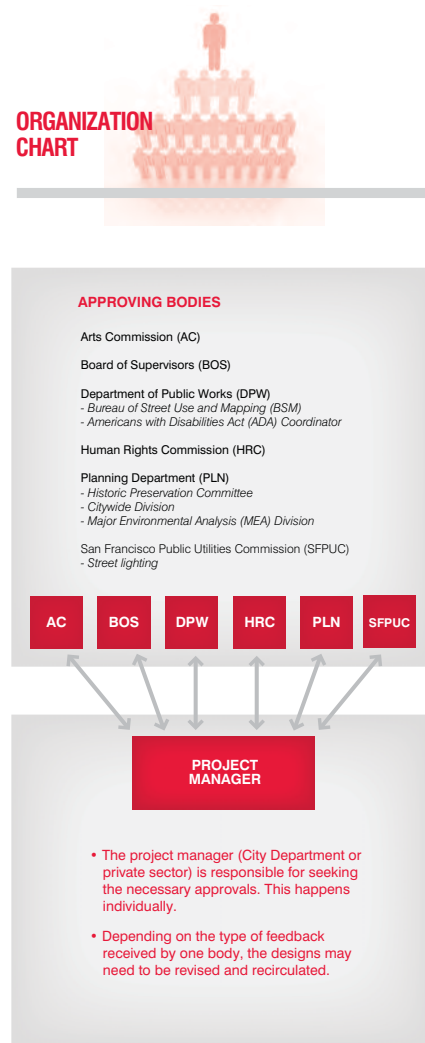
The Controller's Office will be making recommendations on how to improve the City's streetscape maintenance as part of the Better Streets Institutional Analysis, described above.

### Typical streetscape design process

The typical steps for streetscape improvement projects from project identification to completion are shown in Figure 2.11. Many of these steps vary from project to project, depending on funding source, physical conditions, and agencies that need to be involved. In addition, though the process appears linear, there is often considerable iteration, meaning there is considerable back and forth between steps to deal with issues that have been brought up at a particular step. This often results in time delays and costly design revisions. There is a need for greater coordination and review at early stages of the street design process to minimize the need to make significant revisions later on in the process.



FIGURE 2.11  
EXISTING CITY STREET DESIGN PROCESS



## OTHER PLANNING EFFORTS

### Stormwater Design Guidelines

The San Francisco Stormwater Design Guidelines (SDG), developed by the Port of San Francisco and the SFPUC, will improve San Francisco's environment by reducing pollution in stormwater runoff in areas of new development and redevelopment. The SDG will be applied in areas of San Francisco served by separate storm sewers that discharge directly to local lakes or San Francisco Bay. The Draft SDG was released in February 2009.

### Transit Effectiveness Project

The Transit Effectiveness Project (TEP) is a project to review, evaluate, and make recommendations on the existing Muni transit system, with the goals of making service more attractive to the public and stabilizing operating costs. Draft TEP recommendations were endorsed by the SFMTA Board in October 2008.

### San Francisco Bicycle Plan

The San Francisco Bicycle Plan plans for the improvement of bicycle facilities in order to increase bicycling for transportation and recreation throughout San Francisco. The Bicycle Plan was adopted by the SFMTA Board in June 2009.

## EDUCATION

The San Francisco Department of Public Health (DPH) Community Health Promotion and Prevention (CHPP) Branch coordinates with other City agencies to promote pedestrian safety and comfort through community awareness, advocacy, and education. The awareness and advocacy program focuses on building local community-based organizations' capacity building through its mini-grant program. The education program tries to change social norms through media campaigns which highlight pedestrian safety, traffic enforcement, and traffic engineering.

Since 2001, DPH has awarded mini-grants to community-based organizations (CBOs) to work on pedestrian traffic and safety in their respective communities. DPH helps each CBO collect data and provide ongoing education, training, and technical assistance to CBO awardees. DPH then helps CBOs identify engineering, enforcement, encouragement and education solutions to enhance pedestrian safety.

DPH and SFMTA have conducted an annual media outreach campaign since 2002. Themes of DPH's media campaign include preventing aggressive driving, drinking and driving, red-light running, increasing courtesy between drivers and pedestrians, and reducing speeding.

In addition to preventing pedestrian injuries, DPH-CHPP actively works to promote physical activity in San Francisco, working closely with the Shape Up SF Coalition - a public/private partnership whose mission is to increase the awareness of and opportunities for increased physical activity and improved nutrition where people live, play, work and learn.

DPH has launched the Safe Routes to Schools program. The main goals of Safe Routes to School are to:

- increase bicycle, pedestrian, and traffic safety around schools;
- decrease traffic congestion around schools;
- reduce childhood obesity by increasing number of children walking and biking to school; and
- improve air quality, community safety and security, and community involvement around school.

SFMTA's School Area Safety Program also promotes pedestrian safety education and awareness. The program's achievements include:

- supporting and promoting Walk to School Day;
- developing and providing schools with educational materials about walking and biking safely;

- attending school events and fairs to promote safe walking and biking and to educate children about traffic safety;
- meeting with schools to discuss traffic safety and developing strategies to tame school-area traffic; and
- providing flyers and warning tickets about unsafe driving behavior in school zones.

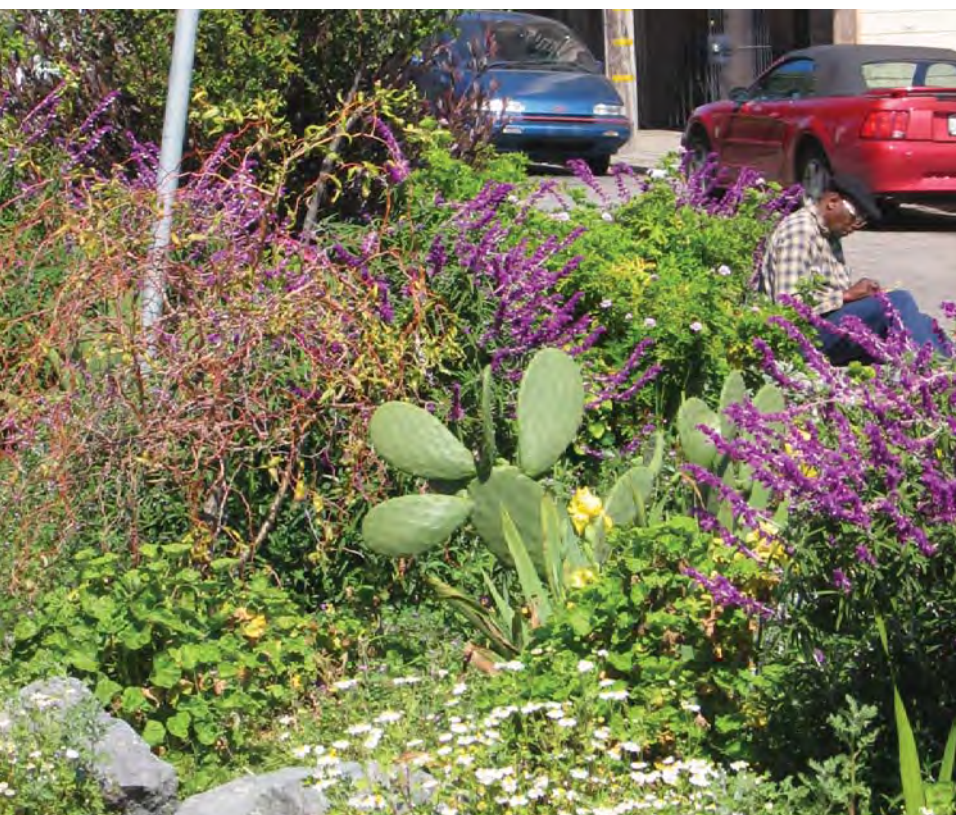
## ENFORCEMENT

Traffic and parking enforcement is carried out by the San Francisco Police Department (SFPD) and the SFMTA. SFMTA Traffic Company and the SFPD enforce traffic violations such as speeding, violation of pedestrian right-of-way, and the like.

SFMTA, in collaboration with the SFPD, enforces parking violations. Roughly 2,000,000 parking citations were issued in FY06/07. Of these, about 78,000 or 4.25% related to parking in a pedestrian area, including 36,000 or 2% for vehicles illegally parked on the sidewalk, 32,000 or 1.75% for illegal parking in a driveway, and 10,000 or .5% for illegal parking in a crosswalk.

DPW approves permits for sidewalk uses and cites sidewalk obstructions to ensure proper sidewalk safety, accessibility, and maintenance. DPW inspects sidewalk condition (by district), street improvements, utility excavations, and tables and chairs and merchandise display permits in commercial districts in response to permits and to neighborhood complaints.





### ➔ Making Community Streetscape Improvements

Community-led improvements represent a significant positive contribution to the City's streetscape environment. Individuals or community groups may be involved in the design, construction, or maintenance of improvements to the public right-of-way (with appropriate permits) such as adding sidewalk plantings, reclaiming street areas for community space, or placing café seating or merchandise displays on public sidewalks.

The Better Streets Plan is intended to facilitate the ability of community members to make improvements on their own streets. For the first time in the city, the Better Streets Plan provides a comprehensive guide to applicable guidelines for design of streetscape and pedestrian facilities. Where applicable, the Plan references necessary permits and other relevant guidelines and standards for making streetscape improvements. Simultaneously, the City is studying how to streamline its street design and permitting process, making it simpler and more straightforward for community members and others to navigate.

Depending on the scope of the work, a community-led project may require one of a number of permit types from DPW or other agencies: tables and chairs permit, sidewalk landscape permit, minor encroachment permit, major encroachment permit, or others. The project must meet all applicable guidelines for these permits, and will include agreements for maintenance and liability. Standards and guidelines to ensure proper safety, accessibility, and design must be met.

The Better Streets Plan is intended as a guide: it is not a hard and fast template that must be replicated exactly throughout the city: differences in neighborhood preference, topography, existing infrastructure, and transportation characteristics make this impossible and undesirable. Rather, the Better Streets Plan uses a kit-of-parts approach, describing appropriate standard elements by street type, and potential case-by-case additions. For each particular element in the plan, there are many guidelines. Though circumstances may differ from case to case, the overall design of street improvements should meet with the intent of the plan's goals and policies for the variety of uses for the street.

### ➔ Permits for Private Use of the Public Right-of-Way

Most street improvement permits are available from DPW and can be found at [http://www.sfgov.org/site/sfdpw\\_index.asp?id=32969](http://www.sfgov.org/site/sfdpw_index.asp?id=32969)

Common permits include:

#### **SIDEWALK LANDSCAPE PERMIT:**

Required for a property owner to replace paved sidewalk with landscaping in front of their property

#### **TREE PLANTING PERMIT:**

Required for a property owner to plant a street tree in front of their property

#### **MINOR ENCROACHMENT PERMIT:**

Required for encroachments, either surface or sub-surface, by private properties into the sidewalk area less than 10% of the area, or 25% of the frontage, in front of the adjacent property. Typical encroachments include retaining walls, steps, ADA level landings, and driveway slopes.

#### **MAJOR ENCROACHMENT PERMIT:**

Required for encroachments by private property owners into the right-of-way, either surface or sub-surface, of a more substantial nature. Examples include private utility lines or special paving and grading of the entire right-of-way.

#### **TABLES AND CHAIRS/DISPLAY MERCHANDISE PERMITS:**

Required for placing outdoor seating or merchandise in the public right-of-way.





# CHAPTER

# BOOK



CHAPTER

# 3.0

GOALS & POLICIES

- 3.1 Vision
- 3.2 Preface to Goals and Policies
- 3.3 Ten Elements of Better Streets

# GOALS & POLICIES: THE PATH TO BETTER STREETS

San Francisco's streets should be designed to fulfill a variety of functions – as safe multi-modal transportation corridors, social and recreational spaces, and as a green layer that enhances the City's ecology



# Vision

# 3.1

The Better Streets Plan will result in a street system designed to promote human needs for the use and enjoyment of public streets. It will prioritize the needs of walking, bicycling, transit use, and the use of streets as public spaces for social interaction and community life, following San Francisco’s General Plan, Transit-First Policy, and Better Streets Policy.

The Better Streets Plan will result in streets where people walk and spend time out of choice—not just necessity—because streets are memorable, engaging, safe, accessible, healthy, attractive, fun, and convenient.

The Better Streets plan will result in streets that improve pedestrian connections and linkages among the City’s nodes, hubs, destinations, transit system, and major land use centers.

The Better Streets Plan will result in a green network that enhances the City’s long-term ecological functioning and peoples’ connection to the natural environment.

Finally, the Better Streets Plan will result in improved street-based social opportunities, community life, access, and mobility for all San Franciscans, regardless of cultural identity, income group, neighborhood identity, or mobility level.

**➔ In this chapter:  
10 Elements of Better Streets**

- 01 Memorable
- 02 Supports Diverse Public Life
- 03 Vibrant Places for Commerce
- 04 Promotes Human Use and Comfort
- 05 Promotes Human Health
- 06 Safe
- 07 Convenient Connections
- 08 Ecologically Sustainable
- 09 Accessible
- 10 Attractive, Inviting, and Well-Cared For

Elements are randomly ordered; order does not indicate priority.

*Illustrations in this Chapter by Robin Chiang unless otherwise noted. Diagrams are for illustrative purposes only.*





# Preface to Goals and Policies

## 3.2

This chapter describes goals and policies for San Francisco’s pedestrian environment. The goals describe what streets ought to become. The policies establish a framework for making decisions about design and management of the pedestrian realm, identifying guidelines, and future actions (next steps).

The policies describe City priorities and values regarding streetscape design and management. This chapter presents a high-level summary of appropriate policies and guidelines—specific design guidelines can be found in the following chapters.

This chapter also suggests places where specific code changes may be necessary to amend City codes to incorporate the ideas of the Better Streets Plan.

The template below explains the format of this chapter.

▼ Sample page

### # Element

**Goal:**

Describes the desired ultimate quality for San Francisco’s streets, based on the 10 Elements of Better Streets.

**Objectives:**

Describes the characteristics of what streets that embody the goal are designed to do:

- Objective 1
- Objective 2
- Etc.

	POLICIES	GUIDELINES	NEXT STEPS	AGENCIES
0.0	<b>DESCRIBES HOW TO CREATE STREETS THAT MEET THE GOAL AND OBJECTIVES</b>	Specifies design treatments that achieve the policies.	Identifies further actions to implement the ideas of the Plan	Describes which agencies would carry out the “Next Steps”. Lead agency is shown in blue.
0.1		Guidelines or next steps that require code amendments are shown with a +.		
0.2				

Throughout this document, recommendations for future actions are made using the word ‘should.’ These are meant to encourage implementation of actions that fulfill the goals and policies of this plan. Use of the word ‘should’ is not meant to imply any legal or technical obligation.



# 01 Memorable



**Goal:**

San Francisco’s streets will be designed to give the city and its neighborhoods a recognizable image and provide a means of orientation and understanding of the city.

**Objectives:**

Memorable streets are designed to:

- make San Francisco recognized the world over for innovative streetscape and pedestrian design;
- improve the ability of residents and visitors to understand, imagine, experience, and learn about the city;
- reflect and embody the unique character of San Francisco’s diverse populations and distinct neighborhoods;
- provide residents and visitors with opportunities for fun, excitement, surprise, exploration, and discovery; and
- enhance the human connection to the natural and built environment and ties to San Francisco’s history.

POLICIES	GUIDELINES	NEXT STEPS	AGENCIES
<b>1.1</b> <b>CREATE A DISTINCTIVE, UNIFIED STREETScape ENVIRONMENT FOR SAN FRANCISCO THAT CONTAINS COMMONALITIES BUT IS CUSTOMIZABLE TO INDIVIDUAL NEIGHBORHOODS</b>	Choose street furnishings from a citywide palette of approved site furnishings	Conduct a citywide inventory of existing site furnishings	DPW, Planning, Redevelopment, Port
		Develop a citywide palette of approved site furnishings, such as benches, bicycle racks, transit shelters, trash cans, and the like, and a process for amending the palette, based on criteria including aesthetics, comfort, usability, long-term maintenance, ecological sustainability, life-cycle cost, and ability to customize +	DPW, Planning, Redevelopment, Port, Arts Commission
		Require major new development to provide street furnishings per the City-approved palette	Planning, DPW, Redevelopment, Port, Arts Commission
<b>1.2</b> <b>PROVIDE DISTINCTIVE DESIGN TREATMENTS FOR STREETS WITH IMPORTANT CITYWIDE FUNCTIONS</b>	On streets in the San Francisco General Plan identified as “Important to the City Pattern,” use consistent rows of single species street trees, distinctive, consistent street lighting and site furnishings, special signage, and public art	Update the citywide network of “Streets that are Important to the City Pattern,” (Urban Design Element Map 2: Plan for Landscaping and Lighting) and identify priority projects for improvement +	Planning, SFMTA, DPW, SFPUC
	On streets that are identified as priority pedestrian corridors or zones, provide enhanced pedestrian amenities, facilities, and signage	Update the citywide pedestrian network, and identify priority projects for improvement +	SFMTA, Planning, DPW
	Define special locations such as civic or commercial centers, entries to major open spaces, or community facilities with special streetscape treatments		
<b>1.3</b> <b>DESIGN STREETS TO REFLECT AND STRENGTHEN A SENSE OF NEIGHBORHOOD IDENTITY</b>	Utilize streetscape elements that reinforce the character of specific neighborhoods, such as customizable street furnishings, gateways, and public art	Prioritize improvements for streets that play an important civic or commercial role in neighborhoods	Planning, SFMTA, DPW
	Streetscape improvements in designated historic districts or adjacent to designated historic landmarks shall be consistent with Secretary of the Interior’s Standards. Streetscape improvements in areas of the City that have been found eligible for the California Register or adjacent to structures found eligible for the California Register shall be reviewed on a case-by-case basis by a preservation technical specialist to determine suitability.		

+ Needs code amendment changes

Agency lead in blue



# 02 Supports Diverse Public Life

**Goal:**

San Francisco’s streets will provide opportunities for diverse experiences and encourage people to spend time engaging in social and recreational activities.

**Objectives:**

Streets that support diverse public life are designed to:

- provide spaces that are comfortable and inviting to residents from diverse backgrounds;
- incorporate opportunities for use as open spaces and enjoyment of nature to encourage passive and active recreational activities;
- accommodate public events such as fairs, rallies, parades, and marches on “ceremonial” streets (such as Market Street) in recognition of their role as important democratic spaces; and
- provide opportunities for stopping, sitting, talking, and interacting with neighbors within residential and commercial areas.

	POLICIES	GUIDELINES	NEXT STEPS	AGENCIES
2.1	<b>DESIGN STREETS WITH COMFORTABLE SPACES FOR CASUAL INTERACTION AND GATHERING</b>	Create new spaces for social interaction, such as wide street furnishing zones, corner or mid-block bulb-outs, and the like		
2.2	<b>USE EXCESS PORTIONS OF RIGHT-OF-WAY, SUCH AS OVERLY WIDE LANES, UNUSED STREET SPACE, OR SPACES CREATED BY STREETS COMING TOGETHER AT ODD ANGLES TO CREATE LANDSCAPED AND/OR USABLE AREAS</b>	Use excess street area for public space, landscaped space, and stormwater management	Develop an inventory of excess portions of rights-of-way that could be used for landscaped or usable space	Planning, SFMTA, DPW, SFPUC
			Develop a priority improvement program for reclaiming excess portions of rights-of-way based on criteria such as need for open space, importance to the city pattern, and pedestrian volumes	Planning, SFMTA, DPW, SFPUC
2.3	<b>DESIGN SIDEWALKS TO MAXIMIZE THE AMOUNT OF PEDESTRIAN AND USABLE OPEN SPACE</b>	Use the minimum feasible corner curb radius to provide maximum pedestrian space and visibility, shorten pedestrian crossing distances, and slow vehicle turns +	Facilitate and reduce costs of creating added sidewalk space in the form of sidewalk widenings or bulb-outs +	DPW, SFPUC, SFMTA, Fire
		Design corner and mid-block bulb-outs and medians to the maximum width feasible to provide maximum pedestrian space and visibility and shorten pedestrian crossing distances +	Develop a mechanism to restrict sidewalk narrowings associated with loading and parking for private development, except as required by accessibility regulations or per exceptional circumstances +	Planning, DPW
		Design corner and mid-block bulb-outs to return to the prevailing curb line as sharply as possible to maximize useable and landscaped space +		
		Use excess parking or travel lane widths to widen sidewalks		
		Discourage sidewalk narrowings as part of street re-designs; weigh narrowings against the added value to transit and bicycle travel modes, and the overall effect on pedestrian space, landscaping, and ecological features		
2.4	<b>FACILITATE AND ENCOURAGE ADJACENT RESIDENTS AND BUSINESSES TO MAKE STREETScape IMPROVEMENTS THAT PROMOTE STREET USE AND ACTIVITY, LANDSCAPING, OR OTHER AESTHETIC ELEMENTS</b>		Facilitate the ability of neighbors to create and maintain public space, seating, and art improvements (per City permits) within appropriate areas of the sidewalk, or within excess areas of the right-of-way, that result in enhanced aesthetics or public usability of sidewalk space +	DPW, Planning, SFPUC, SFMTA
			Simplify the existing streetscape improvement process and clarify the existing process for City agencies and private developers	City Administrator, Planning, DPW, SFPUC, SFMTA, SFCTA,
			Provide matching grants for community members to make improvements for excess areas of the right-of-way	DPW, SFPUC
2.5	<b>FACILITATE AND ENCOURAGE TEMPORARY COMMUNITY USE OF STREET SPACE FOR PUBLIC LIFE, SUCH AS STREET FAIRS, PERFORMANCES, AND FARMER’S MARKETS</b>		Simplify the process and clarify guidelines necessary to attain temporary use permits for activities in public right-of-ways +	SFMTA, DPW



# 03 Vibrant Places for Commerce



**Goal:**

San Francisco’s commercial streets will be designed and managed as attractive and exciting destinations that encourage residents and visitors to walk to and use local shopping areas, rather than drive to regional shopping centers.

**Objectives:**

Streets that are vibrant places for commerce are designed to:

- become destinations of choice, rather than just necessity;
- have adequate space for businesses to provide outdoor seating and merchandise displays while maintaining pedestrian accessibility;
- provide temporary space for vendors, kiosks, street musicians, farmer’s markets, streets fairs, or flexible design of the parking lane for pedestrian use; and
- create one continuous street environment by maximizing both sides of a shopping street and facilitating ease of crossing.

POLICIES	GUIDELINES	NEXT STEPS	AGENCIES
<p><b>3.1 IN COMMERCIAL DISTRICTS, FACILITATE AND ENCOURAGE ADJACENT BUSINESSES TO USE OUTDOOR SPACE FOR SEATING AND MERCHANDISE DISPLAYS WHILE MAINTAINING ADEQUATE PEDESTRIAN ACCESS</b></p>	<p>In commercial areas where sidewalk widths do not allow for outdoor restaurant or café seating, evaluate and act on opportunities to widen sidewalks or provide curb extensions</p>	<p>Conduct a citywide inventory of commercial areas and sidewalk widths to identify sidewalks that are too narrow to provide outdoor seating or merchandise displays</p>	<p><b>DPW,</b> Planning, SFMTA, MOEWD</p>
	<p>In commercial districts, explore designs and programs to flexibly use the parking lane for other uses such as public or cafe seating +</p>	<p>Develop a citywide network of commercial areas for street improvements, and identify priority projects for improvement</p>	<p><b>Planning,</b> DPW, SFMTA</p>
		<p>Provide resources and incentives for businesses and work directly with businesses to place outdoor seating and merchandise displays adjacent to their businesses</p>	<p><b>MOEWD,</b> DPW, Planning</p>
		<p>Facilitate the ability of restaurants and cafés to place outdoor seating in front of their businesses per City regulations+</p>	<p><b>Planning,</b> SFMTA, DPW, SFPUC</p>
		<p>Work with merchants associations, Community Benefit Districts, and the like, to provide on-going management of temporary street uses such as outdoor seating, flexible use of parking lanes, or street fairs</p>	<p><b>MOEWD,</b> DPW, Planning</p>
<p><b>3.2 IN COMMERCIAL DISTRICTS, BALANCE THE NEED FOR SHORT-TERM PARKING FOR SHOPPERS AND LOADING FOR BUSINESSES WITH THE NEED FOR PEDESTRIAN-ORIENTED DESIGN</b></p>	<p>Consider the range of parking management strategies in order to make more efficient use of existing parking spaces and allow for more pedestrian space</p>	<p>Conduct on-going studies of parking demand in commercial districts to provide up-to-date, accurate information about parking needs when designing street improvements</p>	<p><b>SFMTA,</b> SFCTA, Planning</p>
	<p>Minimize the impact of loading on pedestrian-oriented design through the use of service alleys (where available), marked loading zones, restricted loading hours, and other loading management strategies</p>		
	<p>Prioritize amenities and use of right-of-way for shoppers who arrive or travel through by foot, bicycle, or transit</p>		

+ Needs code amendment changes

Agency lead in blue



# 04 Promotes Human Use and Comfort

**Goal:**

San Francisco’s streets will be designed to prioritize the everyday needs of people and to support human comfort and enjoyment.

**Objectives:**

Streets that promote human use and comfort are designed to:

- provide facilities such as crosswalks, site furnishings, landscaping, and other elements based on how people use spaces in order to maximize human comfort;
- minimize vehicle intrusions on pedestrian walkways;
- minimize ambient noise from vehicles by calming traffic and providing buffers between the sidewalk and automobile traffic;
- create a favorable microclimate for pedestrians by reducing wind, offering opportunities for sitting or walking in sun and shade, providing welcoming and inviting lighting for pedestrians, and offering shelter from the rain; and
- have slow vehicle traffic.

	POLICIES	GUIDELINES	NEXT STEPS	AGENCIES
4.1	<b>CREATE STREETSCAPES THAT HAVE A VARIETY OF SEATING OPPORTUNITIES FOR ALL USERS</b>	Encourage public seating, both formal (benches, chairs) and informal (seating walls, bollards) as part of street improvement projects		
		Consider comfort, usability, and accessibility in selecting public seating		
		Consider public benefits of seating in the right-of-way when making decision to remove; weigh decisions about short-term maintenance and social concerns against the public values that seating affords, and seek solutions to social problems that do not negatively impact design		
4.2	<b>DESIGN STREETS WITH A COMFORTABLE BUFFER OR SENSE OF SEPARATION FROM PASSING TRAFFIC</b>	Provide or maintain buffering elements such as landscaping, seating walls, and bollards; recognize the importance of on-street parking as a buffer between traffic and sidewalk space		
4.3	<b>DESIGN STREETS WITH A COMFORTABLE MICRO-CLIMATE FOR WALKING, SITTING, OR INTERACTING</b>	Orient new streets to take maximum advantage of solar access and shelter from wind to sidewalks, particularly sidewalk open spaces; locate sidewalk open spaces to receive sun and shelter from wind		
4.4	<b>ON RESIDENTIAL OR SMALL STREETS, CREATE TRANQUIL STREETS THAT ARE RELATIVELY FREE OF NOISE AND VISUAL OVERSTIMULATION</b>	On residential and small streets, calm traffic using elements such as street trees, traffic circles, chicanes, corner bulb-outs, and other traffic calming devices	Identify and update ‘Protected Residential Areas’ (Urban Design Element, Map 7)	Planning, SFMTA, DPW
		On residential and small streets, utilize attractive visual cues and traffic calming to reduce traffic speeds	Prioritize traffic calming improvements within ‘Protected Residential Areas’	SFMTA, Planning, DPW
			In identified ‘Protected Residential Areas,’ create a City ordinance to limit visual clutter and noise +	Planning, SFMTA, DPW
4.5	<b>ON SMALL STREETS, ENABLE OPPORTUNITIES TO CREATE SHARED SPACES THAT PRIORITIZE PEDESTRIANS BUT ACCOMMODATE LIMITED VEHICLES AT SLOW SPEEDS</b>	Design shared public ways to achieve continuous design among pedestrian-only and shared zones, utilizing design features such as special paving, traffic calming, and landscaping to emphasize the pedestrian nature of shared streets +	Identify ‘small streets’ in the City that are appropriate to create ‘home zones’ and identify priority projects for improvements	Planning, SFMTA, DPW, SFPUC
			Create special consideration for shared public ways that enable the City to accept curbless streets for maintenance +	DPW
4.6	<b>MINIMIZE THE IMPACT OF DRIVEWAY CURB-CUTS ON PEDESTRIAN THROUGH TRAVEL AND THE ABILITY TO PROVIDE STREETSCAPE AMENITIES</b>	Design and locate driveway curb-cuts to minimize impact to streetscape amenities and minimize pedestrian/vehicle conflicts +	Restrict curb cuts on key pedestrian corridors, and in civic, commercial, and mixed-use districts as appropriate +	Planning, SFMTA, DPW
		Minimize egress points from properties +		

# 05 Promotes Human Health

**Goal:**

San Francisco’s streets will promote healthy lifestyles by encouraging walking to daily and occasional destinations, minimizing pedestrian injuries, and helping to decrease major chronic diseases related to air quality and pedestrian activity.

**Objectives:**

Streets that promote healthy lifestyles are designed to:

- encourage walking to shops, restaurants, transit, parks, and other destinations to promote daily physical activity and help decrease chronic diseases such as obesity and heart disease;
- reduce pedestrian injury collisions and reduce the severity of pedestrian injuries when they do occur by calming traffic, creating intersections for convenient and safe pedestrian crossings, and reducing the incidence of speeding;
- create attractive and safe pedestrian routes from neighborhoods to important cultural and civic institutions, such as schools, libraries, senior centers, and museums;
- improve ambient air quality and help to decrease chronic diseases such as asthma by providing alternatives to driving alone and by including generous amounts of trees and other plantings;
- create ‘eyes on the street’ through high levels of pedestrian activity, which has been shown to reduce violent injuries; and
- promote high levels of pedestrian activity that encourage social opportunities as well as physical activity, which has been shown to reduce social isolation and associated mental health issues.

	POLICIES	GUIDELINES	NEXT STEPS	AGENCIES
5.1	<b>ENABLE OPPORTUNITIES TO CREATE ACTIVE RECREATIONAL SPACES ON STREETS, SUCH AS PATHS OR POCKET PARKS</b>	Build streets that include space for recreational activities, such as in sidewalk or median pocket parks, particularly in dense neighborhoods that are deficient in open space	Identify areas that are deficient in open space where streets could be used for recreational opportunities, and identify priority projects for improvements	Planning, SFMTA, DPW, SFPUC, Rec/Park
			Clarify maintenance responsibilities and assess maintenance requirements for street-based pocket parks	DPW, Rec/Park
5.2	<b>EMPHASIZE IMPROVEMENTS TO STREETS THAT LINK TO PARKS, RECREATION CENTERS, AND OTHER COMMUNITY USES</b>		Identify streets that are important connectors to parks and open spaces, and identify priority projects for improvement	Planning, SFMTA, DPW, SFPUC, Rec/Park
5.3	<b>DEVELOP AND CONTINUE PROGRAMS AND POLICIES THAT ENCOURAGE THE USE OF PEDESTRIAN FACILITIES FOR PHYSICAL ACTIVITY</b>		Develop, support and expand programs to encourage street-based physical activity, such as the Shape Up Coalition, Safe Routes to School Program, Sunday Streets, and the Walking Challenge	DPH, SFMTA
5.4	<b>USE QUANTITATIVE METHODS TO MEASURE PEDESTRIAN HEALTH, SAFETY, AND WALKING QUALITY</b>		Select and use methodology for measurement of pedestrian health, safety, and quality	DPH, SFMTA, Planning
			Assess neighborhood walking quality based on selected methodology, and use as a criteria in selection of pedestrian improvements	DPH, SFMTA, Planning



\* By promoting safe and attractive pedestrian conditions, all the policies in this chapter promote human health by creating an environment that encourages walking and enhances pedestrian safety. Hence, many of the policies on this page are cross-referenced with other Better Streets goals. This page points out the connections between walkable, active streets and public health.

+ Needs code amendment changes

Agency lead in blue



# 06 Safe

**Goal:**

San Francisco’s streets will be designed to create an environment that supports a high level of pedestrian safety and security.

**Objectives:**

Safe streets are designed to:

- reduce pedestrian injury collisions and fatalities;
- reduce the severity of pedestrian injuries when they do occur by calming traffic, reducing speeding, creating intersections for convenient and safe pedestrian crossings, and ensure safe crossings for seniors, children, and persons with disabilities; and
- maximize personal security by creating more activity and “eyes on the street” and appropriate pedestrian-scale lighting.

	POLICIES	GUIDELINES	NEXT STEPS	AGENCIES
6.1	<b>DESIGN PEDESTRIAN CROSSINGS TO MAXIMIZE PEDESTRIAN SAFETY AND COMFORT</b>	Build curb extensions at corners to shorten crossing distances, maximize visibility, calm traffic, and reduce pedestrian exposure to vehicles	Establish program and funding mechanisms to coordinate curb extensions with curb ramp construction and re-paving projects +	SFMTA, DPW, MOD
		Restrict parking adjacent to corners to enhance pedestrian visibility at crosswalks	Develop a mechanism to require new development to include curb extensions, sidewalk widenings, or other pedestrian safety features as appropriate +	Planning, SFMTA, DPW
		Minimize the number of lanes a pedestrian must cross wherever possible and provide safe pedestrian refuges within the roadway where pedestrians are unable to cross in one signal phase		
		Provide crosswalk markings at all signalized locations, and at unsignalized locations as appropriate	Build upon and refine guidelines for high-visibility crosswalk placement at both controlled and uncontrolled crossings	SFMTA
		Use high-visibility crosswalks at mid-block crossings and in school zones, and consider them at crossings where conditions necessitate greater visibility		
6.2	<b>EMPLOY TRAFFIC CONTROL DEVICES TO MAXIMIZE PEDESTRIAN SAFETY AND COMFORT</b>	Build raised crosswalks at alley entrances to reduce vehicle speeds, and consider their use at other locations	Conduct trials of raised crosswalks on non-alley street types	SFMTA, DPW, SFPUC
		Install pedestrian countdown signals and accessible pedestrian signals at all signalized locations	Conduct studies to determine specific appropriate pedestrian crossing rates	SFMTA
		Calculate pedestrian clearance interval using a walking speed that matches that of pedestrians in San Francisco, including seniors, children, and persons with disabilities		
		Favor signals on short, fixed time cycles over actuated signals; minimize the use of pedestrian push buttons	Support additional research on innovative approaches and technologies to improve pedestrian safety and mobility	SFMTA
6.3	<b>DESIGN INTERSECTIONS SO THAT GEOMETRIES AND TRAFFIC OPERATIONS MAXIMIZE PEDESTRIAN SAFETY AND COMFORT</b>	Implement signal timing techniques that give priority to the pedestrian and reduce speeding through timing progression, including exclusive pedestrian phases and leading pedestrian intervals		
		Use the minimum feasible corner curb radius to provide maximum pedestrian space and visibility, shorten pedestrian crossing distances, and reduce speeding +		
		Prohibit right turns on red at intersections with a high number of pedestrian/vehicle conflicts, or geometric or operational characteristics that might result in unexpected conflicts		
		Minimize right-turn slip lanes; do not build new free right-turn slip lanes		
		Do not create multiple turn lanes that compromise pedestrian safety and convenience; mitigate or eliminate existing multiple turn lanes.		
		Use the minimum IESNA criteria for pedestrian lighting levels.	Upon SFPUC approval, incorporate minimum IESNA pedestrian lighting criteria into street light design specifications	SFPUC

06. Safe



	POLICIES	GUIDELINES	NEXT STEPS	AGENCIES
6.4	<b>ENFORCE TRAFFIC AND PARKING VIOLATIONS THAT COMPROMISE PEDESTRIAN SAFETY, COMFORT, AND ACCESSIBILITY</b>	Aggressively cite for sidewalk parking and work with residents to promote legal on-street parking	Establish a sidewalk parking task force to enforce sidewalk parking violations	SFMTA, Police
		Strictly enforce and support increased fines for right turn on red violations		
		Conduct targeted enforcement of pedestrian right-of-way violations (crosswalk stings for drivers)		
		Reduce speed limits as appropriate and strictly enforce existing speed limits		
		Emphasize design treatments that are self-enforcing with respect to cars parking on the sidewalk such as use of linear planters or site furnishings		
6.5	<b>CONDUCT EDUCATION AND AWARENESS ACTIVITIES TO PROMOTE PEDESTRIAN SAFETY</b>		Educate motorists on right turn on red and pedestrian right-of-way regulations, and the effects of vehicle speed on the incidence and severity of pedestrian collisions	DPH, SFMTA, Police
			Educate pedestrians on the meaning of pedestrian signal phases and symbols and safe crossing practices	
6.6	<b>PRIORITIZE PEDESTRIAN SAFETY IN SCHOOL ZONES</b>	Provide supplementary pedestrian safety measures in school zones, including school crossing guards and yellow high-visibility crosswalk markings, to increase awareness of pedestrians and reduce speeding	Conduct pedestrian education, encouragement, and enforcement activities with schools in coordination with pedestrian safety improvements in school zones	SFMTA, DPH, SFUSD, Police
6.7	<b>DESIGN STREETS TO MAXIMIZE PERSONAL SECURITY</b>	Design streets for personal security by providing amenities that attract people, rather than taking measures that deter use of the space		SFMTA, SFPUC
		Provide adequate pedestrian-scale lighting that makes the pedestrian visible, avoiding elements that create dark corners with poor visibility		
		Locate transit stops in places that are active and visible to maximize personal security of waiting transit riders		
6.8	<b>DESIGN STREETS TO CALM TRAFFIC AND REDUCE SPEEDING</b>	On residential and small streets, calm traffic using elements such as street trees, traffic circles, chicanes, corner bulb-outs, and other traffic calming devices	Create/update design guidelines for approved traffic calming measures and roadway dimensions to reduce vehicle speeds and enhance pedestrian safety +	SFMTA, Planning, DPW

+ Needs code amendment changes

Agency lead in blue



# 07 Convenient Connections



**Goal:**

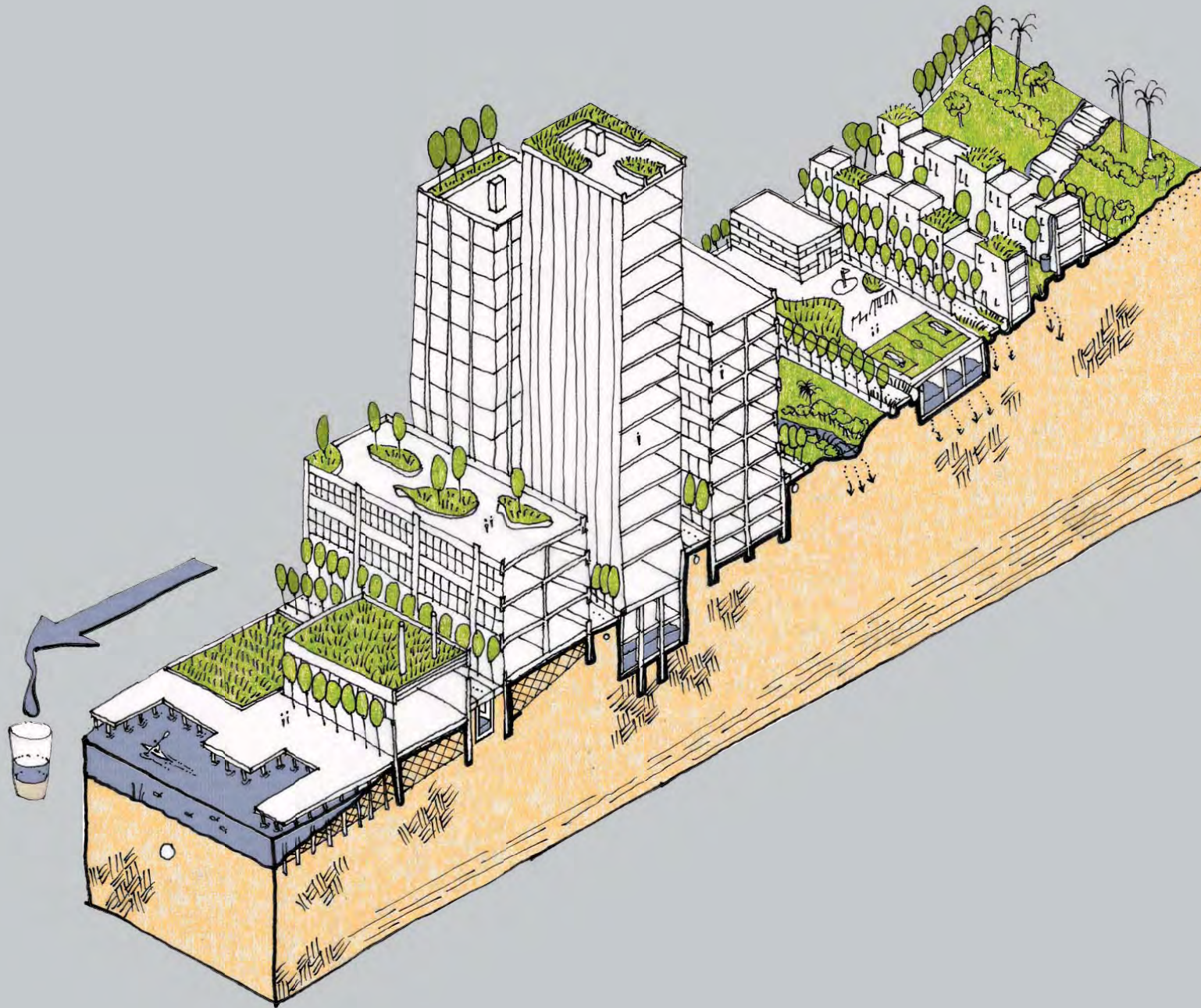
San Francisco’s streets will be designed to facilitate safe, accessible, and convenient connections among major destinations such as transit centers and land use and activity centers.

**Objectives:**

Streets with convenient connections are designed to:

- accommodate pedestrians at locations with high levels of residential or employment density and at destinations that generate a large number of people coming and going;
- connect neighborhoods and commercial districts to major transit centers to encourage transit use;
- utilize wayfinding, signage and amenities to create visually identifiable pedestrian routes between activity hubs; and
- connect streets to parks, water features, and greenways.

	POLICIES	GUIDELINES	NEXT STEPS	AGENCIES
7.1	<b>PROVIDE GENEROUS, UNOBSTRUCTED SIDEWALKS ON ALL STREETS</b>	Provide sidewalks on both sides of all streets to ensure sidewalk continuity	Require newly created streets to meet recommended sidewalk widths per Chapter 4 +	Planning, DPW, SFMTA
		Maximize sidewalk widths as feasible given competing demands; wherever possible meet the recommended sidewalk width per Chapter 4	Evaluate closed crosswalks and re-open as feasible	SFMTA
		Work to open closed crosswalks; avoid closing any additional crosswalks		
		Ensure safe, convenient, and accessible pedestrian rights-of-way along construction sites that require temporary sidewalk closures		
7.2	<b>INCREASE CONNECTIVITY AND ACCESS ACROSS BARRIERS TO PEDESTRIAN TRAVEL</b>	Favor safe, convenient crossings on surface streets wherever possible instead of using pedestrian bridges and tunnels		
		Provide pedestrian connections such as pedestrian bridges across barriers where at-grade crossings are not feasible, such as freeways or rail lines		
7.3	<b>DESIGN TRANSIT WAITING AREAS FOR COMFORT, ACCESSIBILITY, AND EASE OF USE</b>	Improve existing transit waiting areas to improve attractiveness and remove barriers	Identify opportunities to create transit bulbs and transit plazas to create generous waiting areas at major transit stops, and identify priority projects for improvement	SFMTA, Planning, DPW, MOD
7.4	<b>EMPHASIZE IMPROVEMENTS TO STREETS THAT LINK TO MAJOR TRANSIT NODES AND TRANSFER POINTS</b>	Provide direct pedestrian access from activity centers to transit; integrate transit stops into activity centers where possible	Prioritize pedestrian improvements at or near stops and stations on the key transit corridors, including Rapid Network streets as identified by the Transit Effectiveness Project (TEP)	SFMTA, Planning
7.5	<b>DESIGN STREETScape AND PEDESTRIAN FACILITIES TO SUPPORT TRANSIT OPERATIONS</b>	Use curb extensions at cross streets with transit routes to maximize green time available for transit vehicles by minimizing pedestrian crossing distance and time		
		Use transit bulbs and boarding islands to enhance transit operations and reduce sidewalk crowding		
		Install bus bulbs at far-side bus stops to facilitate bus operation, transit signal priority, and pedestrian movement		
		Avoid locating new driveway cuts in bus zones +		
		Balance the necessity for curb radii that are wide enough to accommodate transit vehicles with the need for safe pedestrian crossing conditions		
		Ensure that any traffic calming devices on transit routes are compatible with transit operations		
		Install traffic control devices on major transit corridors that facilitate pedestrian circulation and, when transit vehicles are detected, gives them priority		
7.6	<b>CREATE CONVENIENT, SAFE PEDESTRIAN CONDITIONS AT TRANSIT WAITING AREAS AND TRANSFER POINTS</b>	Consider timed transfers at key transfer points on major lines with less frequent headways or in off-peak hours		
		Create clear wayfinding and directionality at transit transfer points		





08

# Ecologically Sustainable

**Goal:**

San Francisco’s streets will be designed as a green network, enhancing the City’s long-term ecological functioning.

**Objectives:**

Streets that are ecologically sustainable are designed to:

- serve as green corridors through the use of a tree canopy and ground level landscaping to link larger open spaces and wildlife habitats;
- reduce downstream flooding and untreated wastewater overflows into the Bay and ocean;
- ensure the health of street trees and other plantings;
- employ best practices in resource efficiency and conservation in construction materials and energy systems;
- use durable, sustainably harvested, re-used, and/or recycled materials for paving, site furnishings, and other streetscape elements that take into account the materials’ life-cycle costs;
- maximize benefits from the urban forest, including shading, wildlife habitat, and air quality improvements; and
- minimize localized contributions to global warming by using less resource-intensive travel modes such as walking, bicycling, and mass transit.

	POLICIES	GUIDELINES	NEXT STEPS	AGENCIES
8.1	<b>MAXIMIZE OPPORTUNITIES IN THE STREETScape FOR ON-SITE STORMWATER RETENTION AND INFILTRATION</b>	Design streets to meet stormwater performance measures by maximizing use of on-street stormwater retention and infiltration as appropriate	Define and require stormwater performance measures within the public right-of-way +	SFPUC, DPW, Port
8.2	<b>USE SUSTAINABLE STREETScape MATERIALS IN STREET DESIGNS, TAKING INTO ACCOUNT THE LIFE-CYCLE ENERGY COSTS OF SUCH MATERIALS</b>	Utilize sustainable streetscape materials, considering costs, durability, and ecological impacts	Conduct lifecycle analyses of streetscape materials and products to determine the most sustainable choices	DPW, SFMTA, SFPUC, DOE
			Develop an environmentally preferred purchasing program for streetscape materials	DOE, SFPUC, DPW
			Coordinate street improvement projects to minimize wasted materials and maximize the re-use of streetscape materials	City Administrator, Planning, DPW, SFPUC, SFMTA, SFCTA
8.3	<b>MINIMIZE ENERGY USE IN STREET LIGHTING AND OTHER ENERGY-REQUIRING STREETScape ELEMENTS</b>	Use the most energy-efficient available technologies in streetscape designs +	Continue analyzing and demonstrating emerging energy efficient white light LED (light-emitting diode) and induction technologies for use in pedestrian and roadway lighting	SFPUC, DPW, SFMTA
8.4	<b>USE STREETScape LANDSCAPING TO INCREASE THE ECOLOGICAL VALUE OF PUBLIC STREETS FOR PEOPLE AND WILDLIFE</b>	Use plantings in the public right-of-way that emphasize water conservation	Identify streets that have important habitat value by linking natural areas, open spaces, and bodies of water, and identify priority projects for improvement	Planning, DPW, SFPUC, Rec/Park
			On streets near areas with important habitat value, utilize planting palettes and forms that promote habitat value	Planning, DPW, DOE, Rec/Park
			Where appropriate, utilize palettes and forms that provide for local food production	Planning, DPW, DOE, Rec/Park

+ Needs code amendment changes

Agency lead in blue

# 09 Accessible

**Goal:**


San Francisco’s streets will be designed for ease of use and access to destinations for all populations, particularly those with visual or mobility impairments.

**Objectives:**

Accessible streets are designed to:

- achieve best practices in universal design to create clear, easy, and unobstructed connections between all destinations for all users;
- promote access and enjoyment for the broadest range of users, including people with disabilities and seniors;
- build a citywide pedestrian network that will help to connect activity centers, and identify and remedy gaps in pedestrian accessibility to destinations; and
- make improvements equitably in neighborhoods across the city, with a particular focus on historically underinvested districts.

	POLICIES	GUIDELINES	NEXT STEPS	AGENCIES
9.1	<b>ENSURE THAT STREETScape AND PEDESTRIAN PROJECTS MEET UNIVERSAL DESIGN PRINCIPLES.</b>	Provide pedestrian and streetscape amenities that are accessible to all users	Inventory, evaluate, and remove barriers and obstructions in sidewalk and corner clear zones, and provide ongoing maintenance and enforcement.	MOD, DPW, Port, SFMTA
		Ensure that sidewalks and corner clear zones remain free of obstructions, and remove barriers as feasible		
9.2	<b>ENSURE THAT STREETScape AND PEDESTRIAN PROJECTS MEET LEGALLY-MANDATED ACCESSIBILITY REQUIREMENTS FOR PUBLIC RIGHTS-OF-WAY</b>	Provide at least the minimum sidewalk width on all sidewalks per federal, state, and local accessibility standards	Prioritize curb ramp construction and barrier removal per ADA transition plans for curb ramps and sidewalks +	MOD, DPW, Port, SFMTA
		Build curb ramps at all pedestrian crossings per federal, state, and local accessibility standards	Coordinate curb ramp funding and installation with traffic calming and pedestrian safety efforts	MOD, DPW, Port, SFMTA
		Install accessible pedestrian signals and pedestrian countdowns at all signalized locations	Clarify thresholds for projects that must include ADA facilities such as curb ramps and passenger loading zones +	MOD, DPW, Port, SFMTA
		Provide accessible waiting and boarding areas at all transit stops per federal, state, and local accessibility standards		
9.3	<b>MAINTAIN ACCESSIBILITY AROUND CONSTRUCTION ZONES PER CITY STANDARDS</b>		Enforce safe paths of travel guidelines and relevant DPW director’s orders around construction zones	DPW, SFMTA

 **Principles of Universal Design**

Universal design consists of the following seven principles:

1. **Equitable Use** - The design is useful and marketable to people with diverse abilities.
2. **Flexibility in Use** - The design accommodates a wide range of individual preferences and abilities.
3. **Simple and intuitive** - Use of the design is easy to understand, regardless of the user’s experience, knowledge, language skills, or current concentration level.
4. **Perceptible Information** - The design communicates necessary information effectively to the user, regardless of ambient conditions or the user’s sensory abilities.
5. **Tolerance for Error** - The design minimizes hazards and the adverse consequences of accidental or unintended actions.
6. **Low Physical Effort** - The design can be used efficiently and comfortably and with a minimum of fatigue.
7. **Size and Space for Approach and Use** - Appropriate size and space provided for approach, reach, manipulation, and use regardless of user’s body size, posture, or mobility.

More information on universal design can be found at The Center for Universal Design’s web site <http://www.design.ncsu.edu/cud/>

+ Needs code amendment changes

Agency lead in blue



# 10 Attractive, Inviting and Well-Cared For

**Goal:**

San Francisco’s streets will be beautiful, create an engaging visual impression, appeal to senses of sight, smell and sound, and encourage a sense of ownership and civic pride that is reflected in streets’ physical appearance and level of activity.

**Objectives:**

Attractive, inviting and well-cared for streets are designed to:

- be generously planted with trees and other vegetation appropriate to the street, microclimate, and context of the built environment;
- reinforce the character of San Francisco and its local districts and neighborhoods;
- use high-quality materials for site furnishings, paving materials, and street and pedestrian lights;
- efficiently locate signage, signals, utility infrastructure, and similar utilitarian elements to minimize their visual impact on the street;
- provide lighting that recognizes the special needs of pedestrians, results in a safe, inviting and aesthetically pleasing nighttime environment for all users, and minimizes glare and light loss to the night sky and into neighboring buildings;
- enable and encourage opportunities for community stewardship, volunteerism, and local adoption of street care;
- provide adequate maintenance for streets such that they reflect a high level of plant health, cleanliness, and repair; and
- design and manage streets to allow for individualization and the ability for community members to take ownership in the look and feel of the street.

	POLICIES	GUIDELINES	NEXT STEPS	AGENCIES
10.1	<b>MAXIMIZE OPPORTUNITIES FOR STREET TREES AND OTHER PLANTINGS</b>	Locate street trees first in available locations before laying out other street furnishings	Encourage and incentivize property owners to remove sub-sidewalk basements	DPW, Planning, DBI  Planning, DPW, SFPUC
		Allow tree plantings as near as possible to intersections for visibility of pedestrians, signs, and signals in order to slow traffic and visually narrow the street and intersection +	Require new development to provide in-sidewalk planters in addition to street trees as appropriate +	
		Allow trees and plantings to be as near as is practicable to utilities and other objects in the right-of-way while still maintaining appropriate clearances +		
		Allow, and encourage as appropriate, tree basins to be placed in parking lanes where sidewalks are narrow or where there is a desire to further narrow the visual width of the roadway +		
10.2	<b>USE URBAN FOREST ELEMENTS TO IMPART DESIGN DEFINITION AND NEIGHBORHOOD IDENTITY</b>		Conduct a citywide urban forest plan to identify appropriate form, color, layout and other design criteria for urban forest plantings	Planning, DPW, DOE
10.3	<b>MINIMIZE VISUAL CLUTTER IN THE STREETScape ENVIRONMENT</b>	Minimize the number of traffic signs, street light, catenary, traffic signal, and other utility poles, and share poles wherever feasible	As part of on-going parking management programs, replace single-space parking meter poles with multi-space meters	SFMTA, Port  Planning, DPW,
		Remove single-space poles where multi-space meters are installed, and replace bicycle parking as appropriate	Require development to provide utility plans that indicate size and location of utilities in the streetscape with initial development submissions	
		Share sub-surface utility vaults wherever feasible		
		Choose locations for sub-surface utility vaults, surface-mounted utilities, and overhead utilities that minimize impact to street trees, other plantings, and street furnishings		
10.4	<b>ENSURE CONSISTENCY AND CONTINUITY IN THE DESIGN OF STREETScape ELEMENTS</b>	Align site furnishings within the furnishings zone of the sidewalk to minimize potential obstructions and create aesthetic consistency	Require and enforce that sidewalk excavators replace special paving in-kind on all City streets +	DPW

10. Attractive, Inviting and Well-Cared For



	POLICIES	GUIDELINES	NEXT STEPS	AGENCIES
10.5	<b>ENSURE ADEQUATE LIGHT LEVELS AND QUALITY FOR PEDESTRIANS AND OTHER SIDEWALK USERS; MINIMIZE LIGHT TRESPASS AND GLARE TO ADJACENT BUILDINGS</b>	Select a palette of streetlights based on criteria including aesthetics, light quality and color, long-term maintenance, and energy efficiency	Conduct a citywide inventory of existing streetlight poles and fixtures	SFPUC, DPW
			Update and simplify the citywide palette of approved streetlight poles and fixtures +	SFPUC, Planning, DPW, SFMTA
		Emphasize lighting for pedestrians; include pedestrian lighting in street improvement projects as appropriate	Develop a citywide pedestrian lighting standard geared toward lighting sidewalks +	SFPUC, Planning, DPW, SFMTA
			Work with regional, state, and federal funding entities to include pedestrian lighting as an eligible expenditure in streetscape and transportation funding sources +	SFPUC, SFCTA, Planning, DPW, SFMTA
10.6	<b>USE HIGH-QUALITY, DURABLE MATERIALS IN THE DESIGN OF STREETSAPES</b>	Select streetscape materials based on criteria including life-cycle cost of initial capital, long-term maintenance, and replacement costs	Develop a citywide palette of site furnishings	DPW, Planning, Redevelopment, Port, Arts Commission
		Use special paving treatments to delineate special public space areas		
10.7	<b>INCLUDE AND INTEGRATE PUBLIC ART INTO STREET IMPROVEMENTS</b>	Integrate public art as an essential part of streetscape designs from the beginning of the design process when included	Clarify thresholds of street improvement projects that should include public art +	Arts Commission
10.8	<b>BALANCE DESIRED DESIGN TREATMENTS WITH THE ABILITY TO PROVIDE ADEQUATE MAINTENANCE</b>		Encourage community stewardship programs, such as Community Benefit Districts, Landscape and Lighting Districts, and property owner maintenance agreements to provide streetscape maintenance	DPW, SFPUC, MOEWD
			Build maintenance funding into capital streetscape improvement projects	DPW, SFPUC
			Explore the creation of a long-term streetscape maintenance fund	DPW, SFPUC
			Develop program ideas to have the City assist property owners with sidewalk and street tree maintenance	DPW

+ Needs code amendment changes

Agency lead in blue



▼ Dolores Street







# CHAPTER

# 40



CHAPTER

# 4.0

## DESIGNING GREAT STREETSCAPES

### 4.1 Street Types

- Designs by Street Type

### 4.2 Overall Streetscape Guidelines

- Intersection Design
- Sidewalk Width and Zones
- Streetscape Layout

# APPROACH: DESIGNING GREAT STREETSCAPES

Good streetscape design begins with an approach that emphasizes wholeness, considering how various elements interact to create an overall streetscape composition. This chapter describes basic principles and guidelines to achieve unified designs on a variety of street types.



Much more than a strip of sidewalk laid down next to a roadway, a great streetscape incorporates a holistic vision for the use of the street which takes into account the needs of all users. With well designed streetscapes, our city's streets can become a fundamental component of a healthy, vital and thriving public realm. The right proportions, unique spaces, and appropriate amenities can make a streetscape a comfortable and memorable place where people want to spend their time. The following sections detail the approach and critical considerations involved in the creation of great streetscapes.

**Chapter 4** presents a framework for designing a great pedestrian environment. **Section 4.1** describes street types and appropriate standard and case-by-case elements for each street type.

**Section 4.2** describes the general guidelines for overall streetscape design, including design of pedestrian-friendly intersections, appropriate sidewalk widths and zones, and general considerations for the layout of streetscape elements along a sidewalk.

To use this document to arrive at a preferred street design, follow these steps:

1. Determine street type (See Section 4.1)
2. Identify appropriate elements for that street type (4.1)
3. If sidewalk is less than recommended width, determine whether it is feasible to widen sidewalks to meet or exceed the recommended width (4.2)
4. Locate elements according to sidewalk zone and streetscape layout guidance (4.2)
5. Design and locate individual elements per the specific guidance by element (Chapters 5 and 6)





# Street Types

## 4.1

Good street design begins with an understanding of the street context. Different streets have different conditions, and merit differing design considerations.

The street types listed below form the basis of the design recommendations in the Better Streets Plan. These street types are not intended to replace official functional transportation classifications (shown in the Transportation Element of the San Francisco General Plan) but instead are meant to serve as a guide for designing appropriate streetscape environments.

The street types in this plan are defined by land use characteristics and transportation characteristics. Special street types that merit unique design approaches are called out individually. For all street types, designers should consider additional special roles a street may play, such as importance as a transit corridor, or having particular ecological significance.

In some cases, the point of a project may be to change the function of a street, for example from a major throughway to a traffic calmed street, or an alley to a shared public way. The ultimate role for the street should be used when designing improvements.

Street types used in this document are described below.

### DETERMINING STREET TYPE

In determining street type for a particular project, designers should begin by determining adjacent land use: is it primarily residential, commercial, industrial, or mixed use? Second, what are the transportation characteristics: is it a major through corridor with high traffic volumes and speeds, or does it serve a more local function with lower traffic volumes and speeds? Is it in a downtown location? Finally, does it have special characteristics such that place it into one of the “Special Streets” categories?

#### Street Types Used in This Plan

The street types outlined below form the basis of the design recommendations in the Better Streets Plan and should be used to determine appropriate design treatments.

##### COMMERCIAL

- Downtown commercial
- Commercial throughway
- Neighborhood commercial

##### RESIDENTIAL

- Downtown residential
- Residential throughway
- Neighborhood residential

##### INDUSTRIAL/MIXED-USE

- Industrial
- Mixed-use

##### SPECIAL

- Parkway
- Park edge
- Multi-way boulevard
- Ceremonial (Civic)
- Alley
- Shared Public Way
- Paseo (Pedestrian-only)

### 1) Determine land use context

To determine land use context, see Figure 4.1.

In some areas, multiple zoning districts may exist on the same block or be scattered across the area. Or, a street may form the boundary between two districts of differing character. In these cases, the designer should consider the predominant character of the area to determine appropriate streetscape design. The designer should consider the goals of the project and the needs of existing and potential future land uses when deciding on the appropriate design, and create a consistent streetscape design for the corridor.

### 2) Determine transportation context

Throughway streets carry greater volumes and higher speeds of vehicle traffic, while neighborhood streets have lower speeds and volumes. For design of the pedestrian realm, the goal for residential throughways focuses on buffering pedestrians from vehicular traffic and improving conditions for pedestrians at crossings. The goal for residential neighborhood streets focuses on calming traffic and providing neighborhood amenities.

Throughway streets (both residential and commercial) include streets identified in the San Francisco General Plan Transportation Element Map 6: Vehicular Streets as “Major Arterial,” “Transit Conflict Street,” or “Secondary Arterial.” Neighborhood streets (both residential and commercial) are those streets not identified as such. Downtown streets include those listed as Downtown in Figure 4.1.

### 3) Identify special conditions

A street may already exhibit a unique condition, or the point of a project may be to convert a street to a special street.

**Parkways:** Parkways are streets with significant planted areas (generally greater than 15 to 20’ wide) that may be used as open space, either in the medians or edges of the roadway.

**Park Edge Streets:** Park edge streets are located along the edges of major city parks, such as Golden Gate Park, McLaren Park, or portions of the waterfront. Park edge streets have open space on one side and development on the other side, with a pattern that continues for several blocks at least.

**Boulevards:** Boulevards are streets that separate through traffic from local access by medians.

**Ceremonial (Civic) Streets:** Ceremonial streets are grand civic spaces which serve as major gathering spots and serve as well-known public spaces and attractions. Ceremonial Streets are unique, and there are limited examples in the city.

**Alleys:** An alley is a public right-of-way less than 30 feet in width.

**Shared Public Ways:** Shared public ways are streets designed at a single-surface that share space among pedestrians, bicycles, and vehicles.

**Paseos (pedestrian-only streets):** Paseos are right-of-ways closed to motorized vehicles.

## GATEWAYS AND TRANSITIONS

An individual street may fit into one or more street types. Consecutive blocks of a street may fall into different street types where land use, context, and function of the street shift. Designs may shift accordingly.

Locations where different street types intersect may warrant special design treatments. For example, where neighborhood residential streets intersect with major throughways, a gateway treatment such as a planted median island or other traffic calming feature may be appropriate. Similarly, where freeway on and off ramps intersect with city streets, there may be a need to highlight this transition to alert drivers to the fact that they are entering a surface street where pedestrians are likely to be present.

## DESIGNS BY STREET TYPE

The following pages illustrate typical design treatments and appropriate elements by street type. Overall layout should follow the sidewalk zone and streetscape layout guidelines in Section 4.2. Individual elements should follow the design guidelines found in Chapters 5 and 6.

A sample page is provided to illustrate the format of this section.

**FIGURE 4.1**  
**DETERMINING STREET TYPE BY LAND USE CLASSIFICATION**

STREET TYPE		ZONING DISTRICT (PER SF PLANNING CODE)
<b>COMMERCIAL</b>	Downtown	C-3, C-2 (C-3 adjacent), CCB (w/in Downtown Streetscape Plan)
	Throughway, Neighborhood	NC, C-2, NCT, CCB (not w/in Downtown Streetscape Plan), CVR, CRNC, MB Retail, MB Hotel
<b>RESIDENTIAL</b>	Downtown	DTR, RC-3, RC-4
	Throughway, Neighborhood	RH, RM, RTO, RED, MB Residential
<b>OTHER</b>	Industrial	C-M, M1, M2, PDR-1, PDR-1-B, PDR-1-G (except Transit-Oriented Retail SUD), PDR-2
	Mixed-use	MUG, MUO, MUR, PDR-1-D, PDR-1-G (Transit-Oriented Retail SUD only), SLR, SLI, SPD, SSO, RSD, UMU, MB districts: Public Facilities, Commercial Industrial, Commercial Industrial/Retail





1. A Downtown Residential street
2. A Residential Thoroughway
3. A Neighborhood Residential street





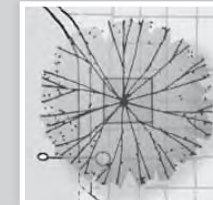
# Street Type

This text gives a brief description of the street type



▲ This image shows a typical sidewalk section, with appropriate elements for each sidewalk zone. Sections are shown at the “Recommended Sidewalk Width” per Section 4.2.

## Standard Improvements



Street trees  
(See Section 6.1)

- This text describes standard improvements. These improvements should be included as part of any streetscape design project on this street type.

# SAMPLE PAGE

## Considerations

- This text describes general considerations for this particular street type

## Additional Guidelines

- These describe specific guidelines that may apply to the choice of appropriate elements for this street type.



### Case by Case Additions



#### 01 Addition

This section shows elements that should be considered for the street type on a case-by-case basis, based on physical conditions, budgets, and neighborhood preferences.

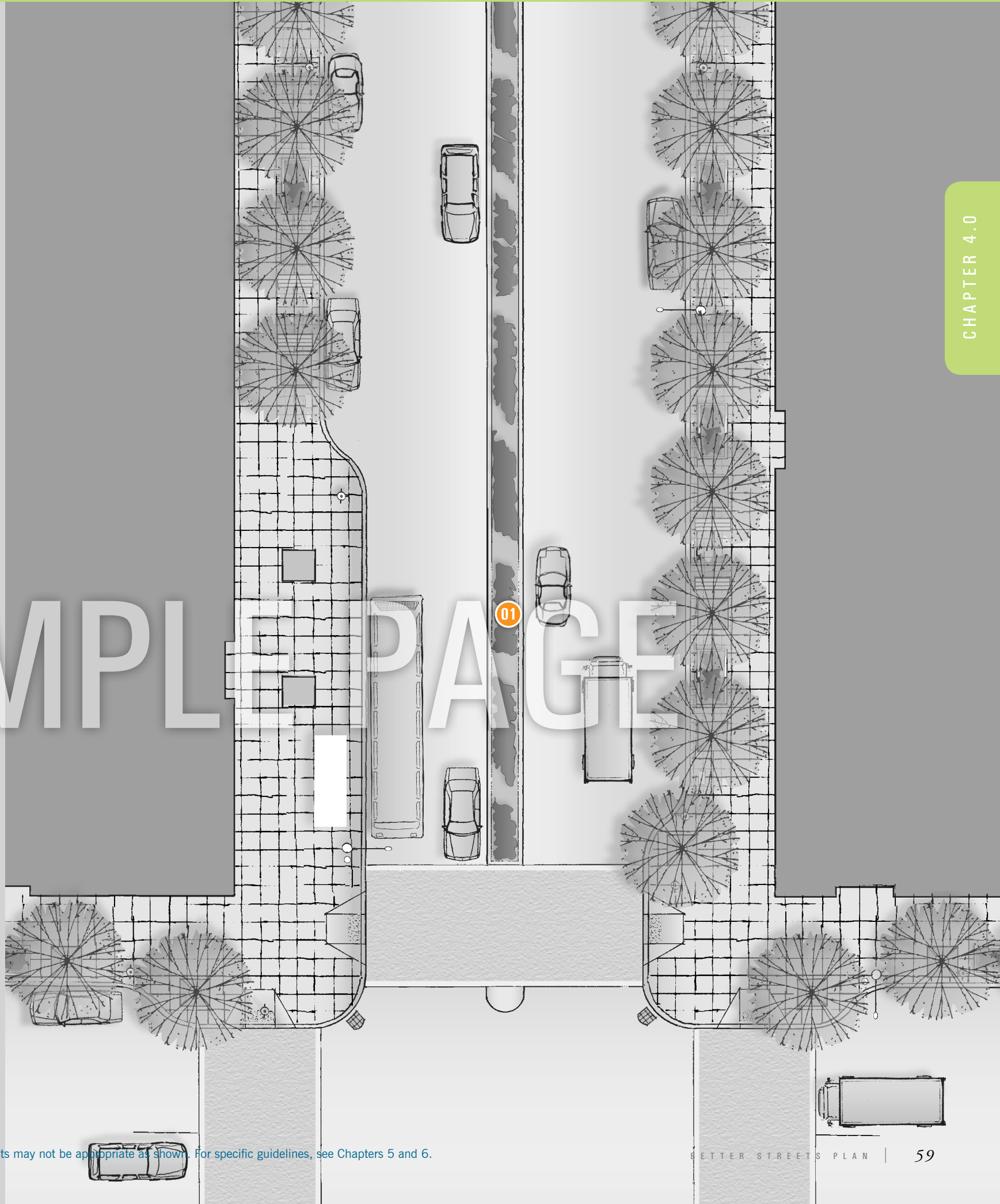
These treatments should generally be considered above and beyond standard treatments, and their appropriateness will vary from project to project.

Case-by-case additions are keyed to the map (not all improvements are shown in site plans).

# SAMPLE PAGE

This image shows a typical plan view for the street type, shown with standard enhancements.

Numbers are keyed to the case-by-case additions. ▶



\*\*Site plans in this chapter are for representational purposes only; individual elements may not be appropriate as shown. For specific guidelines, see Chapters 5 and 6.

# Downtown Commercial

Downtown commercial streets such as Grant or Kearny Streets handle high pedestrian volumes and high levels of activity throughout the day. Due to their importance, visibility, and high levels of pedestrian activity, downtown streets should have generous sidewalks, high levels of pedestrian amenities, and distinctive, formal design treatments.

Streetscape guidelines for downtown commercial streets are described in the *Downtown Streetscape Plan*, adopted in 1995.



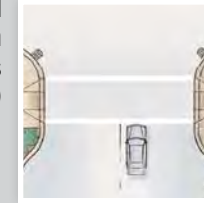
▲ Downtown streets cater to a high volume of local and visiting pedestrians and should reflect a high level of amenity and quality of care.

## Considerations

- High levels of pedestrian activity
- Desire for generous pedestrian environment and public realm
- High volume of through traffic
- Important transit functions
- Access needs for local businesses
- Potential presence of sub-sidewalk basements
- Limited sunlight access to sidewalks

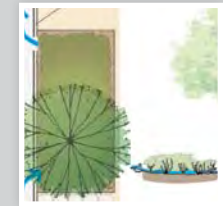
## Standard Improvements

Marked crosswalks with curb ramps (Section 5.1)



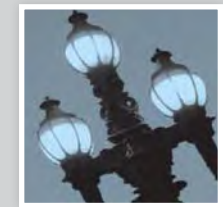
Sidewalk planters (planter boxes) (6.1)

Pedestrian signals (countdown and APS) (5.2)



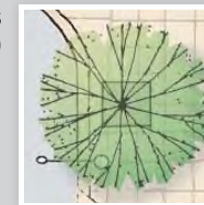
Stormwater control measures (6.2)

Corner curb extensions (5.2)

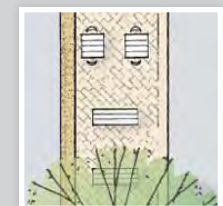


Pedestrian-scale lighting (6.3)

Street trees (6.1)



Special paving in furnishings zone (6.4)



Site furnishings (6.5)

## Additional Guidelines

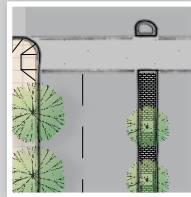
- Downtown Commercial streets should follow the guidelines in the Downtown Streetscape Plan
- For specific stormwater control measures, see Section 6.2.



### Case by Case Additions



**01**  
Mid-block crossing (5.1)



**07**  
Pedestrian refuge island (5.4)



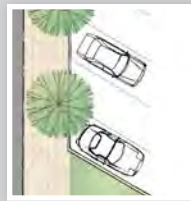
**02**  
High visibility crosswalks (5.1)



**08**  
Transit bulb-out or boarding island (5.5)



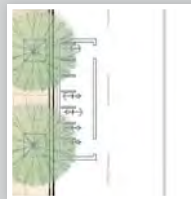
**03**  
Special crossing treatments (warning signs, beacons, etc.) (5.1)



**09**  
Perpendicular or angle parking (5.6)



**04**  
Extended bulb-out (5.2)



**10**  
Flexible use of parking lane (5.6)



**05**  
Mid-block bulb-out (5.2)



**11**  
Sidewalk pocket park (5.8)



**06**  
Center median (5.4)



**12**  
Boulevard treatment (5.8)



\*\*Site plans in this chapter are for representational purposes only; individual elements may not be appropriate as shown. For specific guidelines, see Chapters 5 and 6.

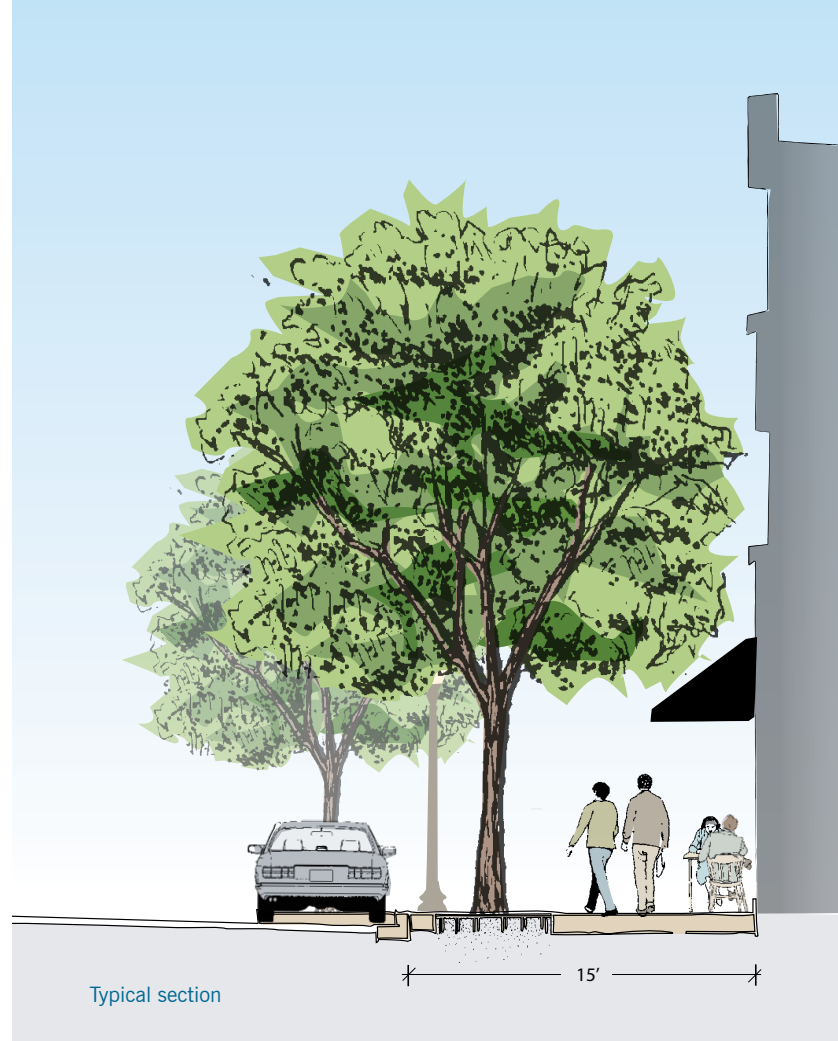


# Commercial Throughways

Commercial throughways such as Van Ness Avenue or Divisadero Street move significant volumes of people across town in a variety of travel modes and attract them to shop, eat, and play from across the city. Vehicular traffic on these throughways tends to be relatively fast and continuous and transit service is often frequent. These streets should have a comfortable pedestrian realm with significant pedestrian amenities and public spaces.

## Considerations

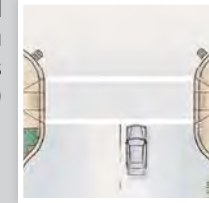
- High levels of pedestrian activity
- Desire for generous pedestrian environment and public realm
- High volume and speed of through traffic
- Important transit functions
- Access needs for local businesses



▲ Commercial throughways attract a high volume of pedestrians and visitors, and are also significant transportation corridors

## Standard Improvements

Marked crosswalks with curb ramps (Section 5.1)



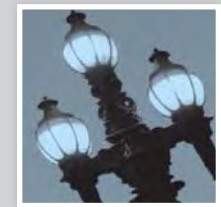
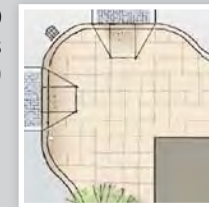
Sidewalk planters (planter boxes) (6.1)

Pedestrian signals (countdown and APS) (5.2)



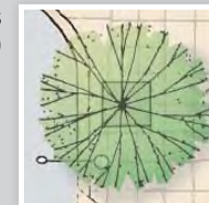
Stormwater control measures (6.2)

Corner curb extensions (5.2)

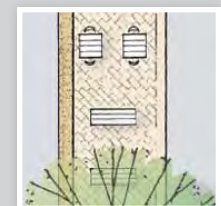


Pedestrian-scale lighting (6.3)

Street trees (6.1)



Special paving in furnishings zone (6.4)



Site furnishings (6.5)

## Additional Guidelines

- Tree grates should be considered in high pedestrian volume areas, where capital and maintenance budgets allow.
- For specific stormwater control measures, see Section 6.2.



Case by Case Additions



**01**  
Mid-block crossing (5.1)



**02**  
High visibility crosswalks (5.1)



**03**  
Special crossing treatments (warning signs, beacons, etc. (5.1)



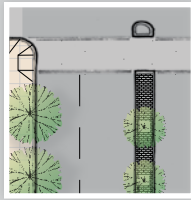
**04**  
Extended bulb-out (5.2)



**05**  
Mid-block bulb-out (5.2)



**06**  
Center median (5.4)



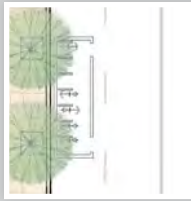
**07**  
Pedestrian refuge island (5.4)



**08**  
Transit bulb-out or boarding island (5.5)



**09**  
Perpendicular or angle parking (5.6)



**10**  
Flexible use of parking lane (5.6)



**11**  
Parking lane planters (5.6)



**12**  
Sidewalk pocket park (5.8)



**13**  
Boulevard treatment (5.8)



\*\*Site plans in this chapter are for representational puposes only; individual elements may not be appropriate as shown. For specific guidelines, see Chapters 5 and 6.



# Neighborhood Commercial

Neighborhood commercial streets, such as Clement, Taraval, Valencia, Polk, and Leland Avenue, include many of San Francisco's most vibrant streets, handling continuous activity throughout the day. They are the streets where San Francisco residents do their daily errands, meet with friends, and shop and play on the weekends.

Short-term parking for customers and space for loading facilities are essential components of commercial districts. However, parking and loading facilities often compete for the same space as desired features such as corner bulb-outs or pedestrian plazas. Managing parking and loading facilities efficiently and effectively can serve both the needs of local businesses while enabling improvements to the public realm.

## Considerations

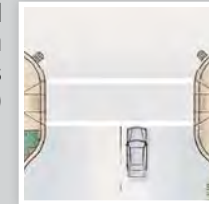
- High levels of pedestrian activity
- Desire for generous pedestrian environment and public realm
- Important transit functions
- Access needs for local businesses



- ▲ Neighborhood commercial streets are the heart of, and serve the daily needs of San Francisco's many neighborhoods

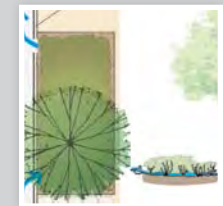
## Standard Improvements

Marked crosswalks with curb ramps (Section 5.1)



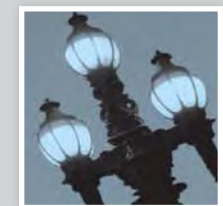
Sidewalk planters (planter boxes) (6.1)

Pedestrian signals (countdown and APS) (5.2)



Stormwater control measures (6.2)

Corner curb extensions (5.2)

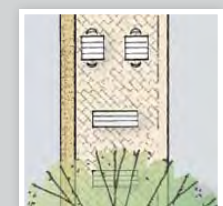


Pedestrian-scale lighting (6.3)

Street trees (6.1)



Special paving in furnishings zone (6.4)



Site furnishings (6.5)

## Additional Guidelines

- Tree grates should be considered in high pedestrian volume areas, or where capital and maintenance budgets allow.
- For specific stormwater control measures, see Section 6.2.



Case by Case Additions



**01**  
Mid-block crossing (5.1)



**02**  
High visibility crosswalks (5.1)



**03**  
Special crossing treatments (warning signs, beacons, etc.) (5.1)



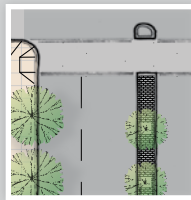
**04**  
Raised crossing (5.1)



**05**  
Extended bulb-out (5.2)



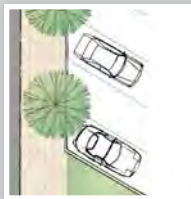
**06**  
Mid-block bulb-out (5.2)



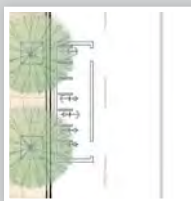
**07**  
Pedestrian refuge island (5.4)



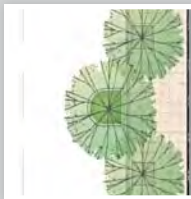
**08**  
Transit bulb-out or boarding island (5.5)



**09**  
Perpendicular or angle parking (5.6)



**10**  
Flexible use of parking lane (5.6)



**11**  
Parking lane planters (5.6)



**12**  
Sidewalk pocket park (5.8)



**13**  
Shared public way (5.8)



\*\*Site plans in this chapter are for representational puposes only; individual elements may not be appropriate as shown. For specific guidelines, see Chapters 5 and 6.

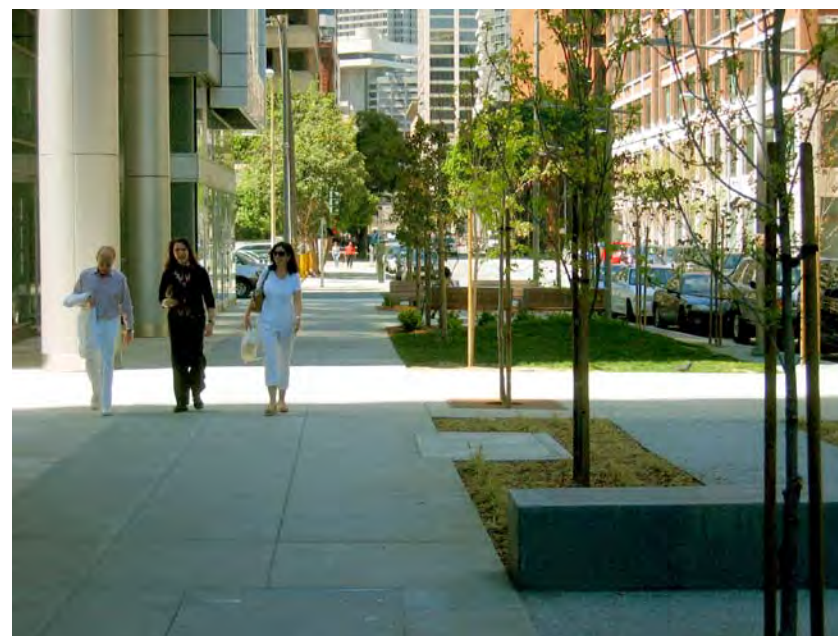
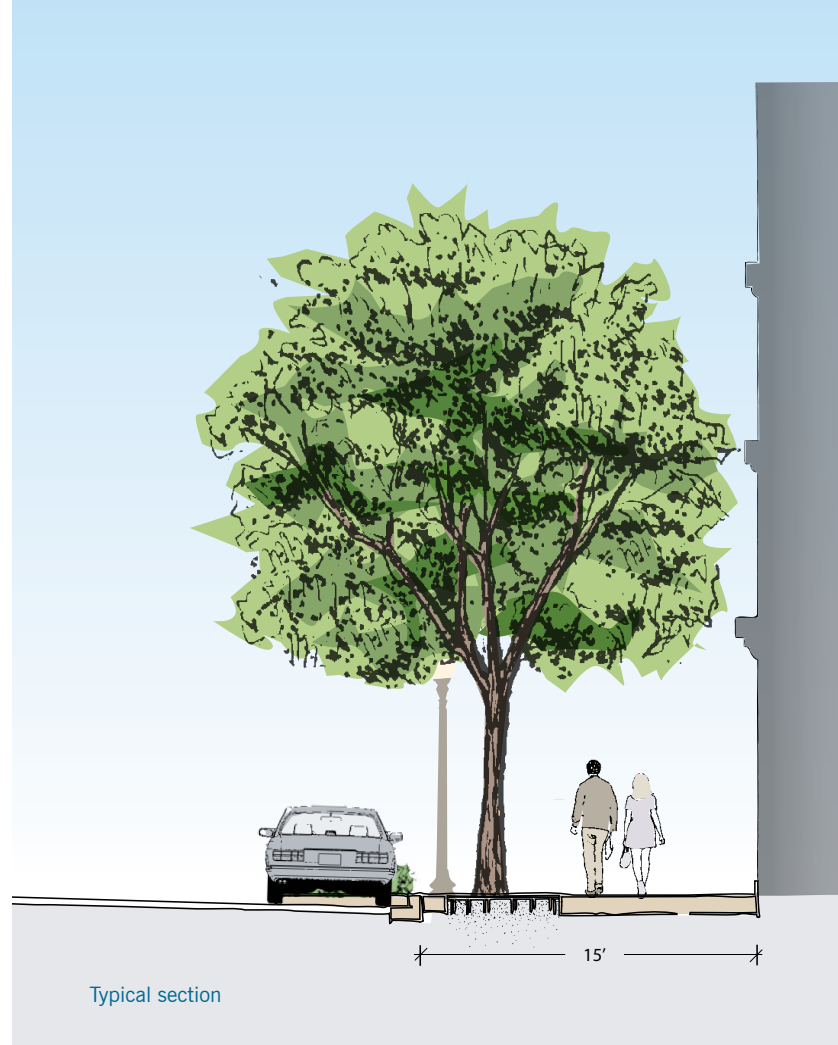
# Downtown Residential

As the city continues to experience economic and population growth, more areas in and adjacent to the downtown, such as Rincon Hill and South Beach, have come to share the density and intensity of the commercial areas of downtown.

These areas have high residential densities and large buildings. As these areas change to residential uses, the streets should be appropriate for residential living, with generous sidewalks, plantings, and furnishings. As many of these areas are deficient in open space, the streets should include places for neighbors to gather, relax, and recreate.

## Considerations

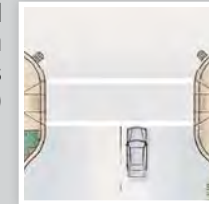
- High levels of pedestrian activity
- Need for increased public open space
- High volume of through traffic



- ▲ Downtown residential streets often must be reformatted to create an appropriate living environment

## Standard Improvements

Marked crosswalks with curb ramps (Section 5.1)



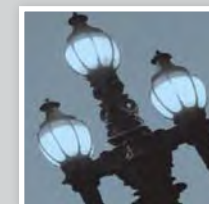
Sidewalk planters (6.1)

Pedestrian signals (countdown and APS) (5.2)



Stormwater control measures (6.2)

Corner curb extensions (5.2)

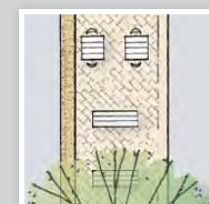


Pedestrian-scale lighting (6.3)

Street trees (6.1)



Special paving in furnishings zone (6.4)



Site furnishings (6.5)

## Additional Guidelines

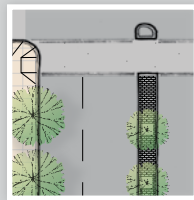
- Tree grates should be considered in high pedestrian volume areas, or where capital and maintenance budgets allow.
- For specific stormwater control measures, see Section 6.2.



Case by Case Additions



**01**  
Mid-block crossing (5.1)



**07**  
Pedestrian refuge island (5.4)



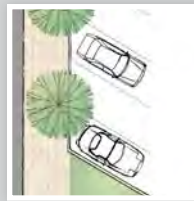
**02**  
High visibility crosswalks (5.1)



**08**  
Transit bulb-out or boarding island (5.5)



**03**  
Special crossing treatments (warning signs, beacons, etc.) (5.1)



**09**  
Perpendicular or angle parking (5.6)



**04**  
Extended bulb-out (5.2)



**10**  
Parking lane planters (5.6)



**05**  
Mid-block bulb-out (5.2)



**11**  
Sidewalk pocket park (5.8)



**06**  
Center median (5.4)



**12**  
Boulevard treatment (5.8)



\*\*Site plans in this chapter are for representational puposes only; individual elements may not be appropriate as shown. For specific guidelines, see Chapters 5 and 6.

# Residential Throughways

Residential throughways such as 19th Avenue, Guerrero, California, Oak and Fell Streets have high levels of fast-moving traffic with residential land uses. As such, they are often not designed to serve residential uses, and can be unpleasant to walk or live along.

Streetscape improvements should focus on buffering the sidewalk and adjacent homes from vehicles passing in the street and providing a generous, useable public realm through landscaping, curb extensions, or widened sidewalks where roadway space allows.



## Considerations

- High volume and speed of through traffic
- Need for increased public open space
- Need for improved pedestrian buffering from through traffic
- Frequent driveway cuts

## Standard Improvements

Marked crosswalks with curb ramps (Section 5.1)



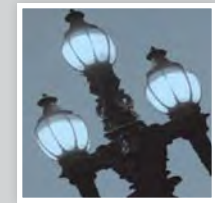
Sidewalk planters (6.1)

Pedestrian signals (countdown and APS) (5.2)



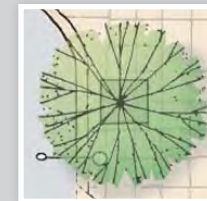
Stormwater control measures (6.2)

Corner curb extensions (5.2)



Pedestrian-scale lighting —at corners (6.3)

Street trees (6.1)



## Additional Guidelines

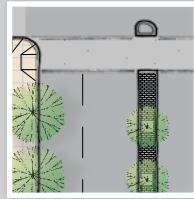
- For specific stormwater control measures, see Section 6.2.
- Special paving in furnishings zone and site furnishings should be considered as capital and maintenance budgets allow.



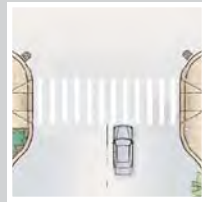
Case by Case Additions



**01**  
Mid-block crossing (5.1)



**07**  
Pedestrian refuge island (5.4)



**02**  
High visibility crosswalks (5.1)



**08**  
Transit bulb-out or boarding island (5.5)



**03**  
Special crossing treatments (warning signs, beacons, etc. (5.1)



**09**  
Perpendicular or angle parking (5.6)



**04**  
Extended bulb-out (5.2)



**10**  
Parking lane planters (5.6)



**05**  
Mid-block bulb-out (5.2)



**11**  
Sidewalk pocket park (5.8)



**06**  
Center median (5.4)



**12**  
Boulevard treatment (5.8)



\*\*Site plans in this chapter are for representational puposes only; individual elements may not be appropriate as shown. For specific guidelines, see Chapters 5 and 6.

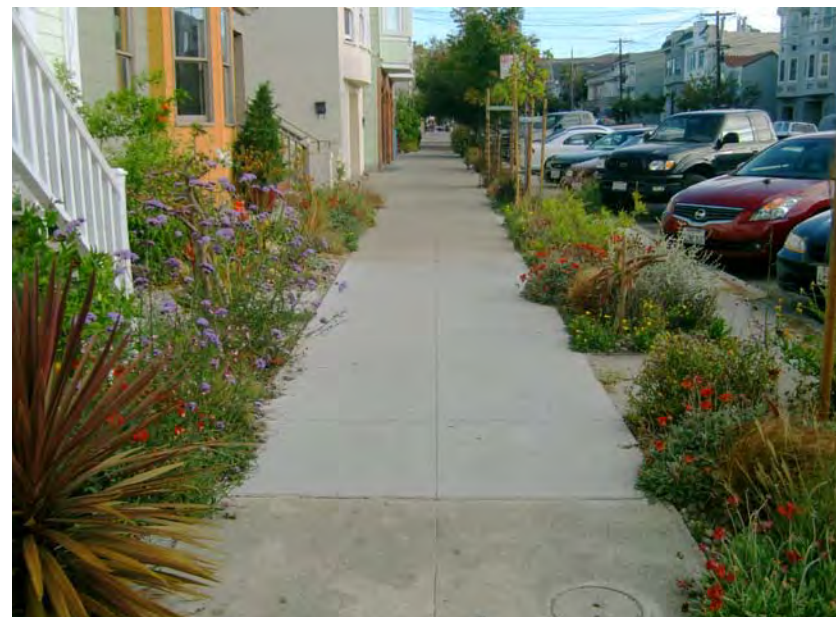
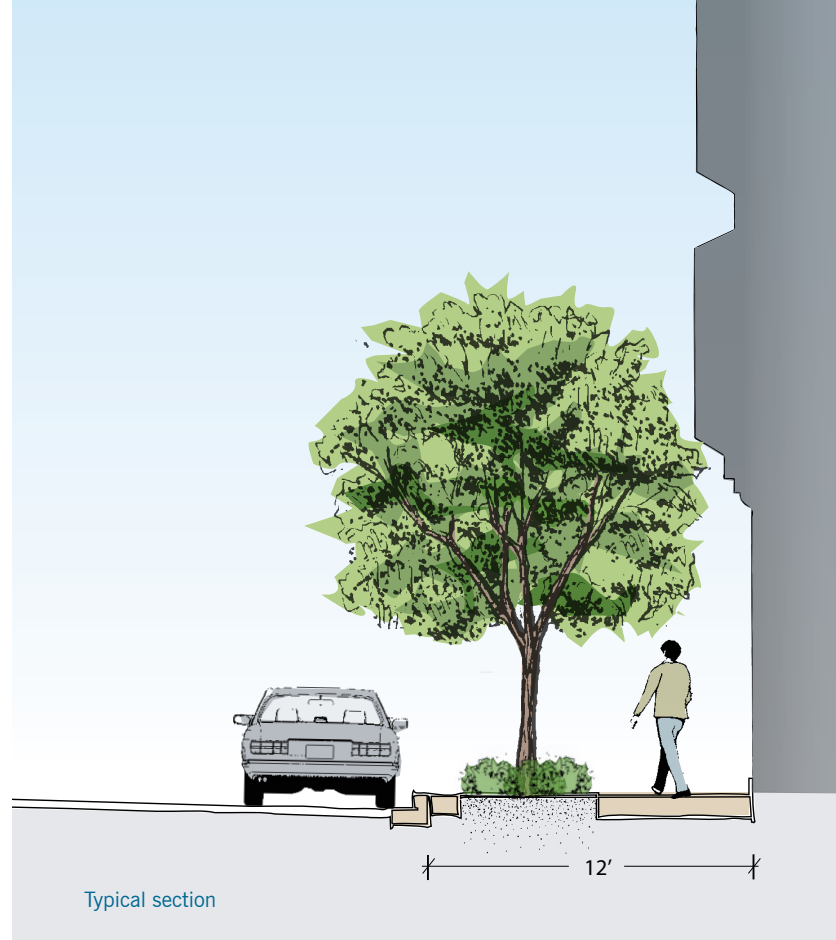
# Neighborhood Residential

Neighborhood residential streets are quieter residential streets with relatively low traffic volumes and speeds. Though they have low levels of activity relative to other street types, they play a key role to support the social life of a neighborhood.

Residential streets should feel safe, comfortable, and cared for. Residents may think of the street outside their home as an extension of their home or a neighborhood commons. Improvements should focus on slowing traffic, providing useable space and amenities, and making improvements that encourage residents to take pride and ownership of the streetscape outside their front door.

## Considerations

- Need for traffic calming in some cases
- Need for increased public open space
- Opportunities for community stewardship
- Frequent driveway cuts



▲ Neighborhood residential streets are San Francisco's front yards, and should encourage neighborly interaction

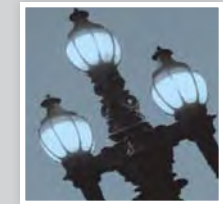
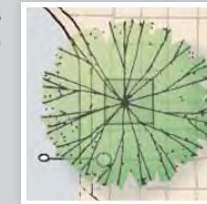
## Standard Improvements

Curb ramps  
(5.1)



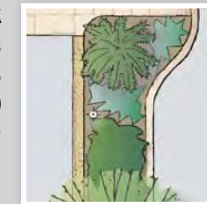
Stormwater control measures  
(6.2)

Street trees  
(6.1)



Pedestrian-scale lighting  
—at corners  
(6.3)

Sidewalk planters  
—continuous planting strip  
(6.1)



## Additional Guidelines

- Neighborhood residential streets with wider crossings (generally > 40'), or higher traffic volumes and speeds (generally > 25 mph) should consider corner curb extensions and marked crosswalks.
- Neighborhood residential streets may include a continuous landscaped permeable strip in the Furnishings Zone.
- For specific stormwater control measures, see Section 6.2.
- Special paving in furnishings zone and site furnishings should also be considered as capital and maintenance budgets allow.



## Case by Case Additions



**01**  
Rased crossing —  
at throughway  
intersections  
(5.1)



**02**  
Extended  
bulb-out  
(5.2)



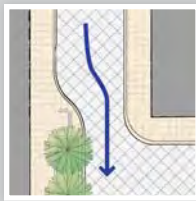
**03**  
Mid-block  
bulb-out (5.2)



**04**  
Perpendicular  
or angle  
parking (5.6)



**05**  
Parking lane  
planters (5.6)



**06**  
Chicane  
(5.7)



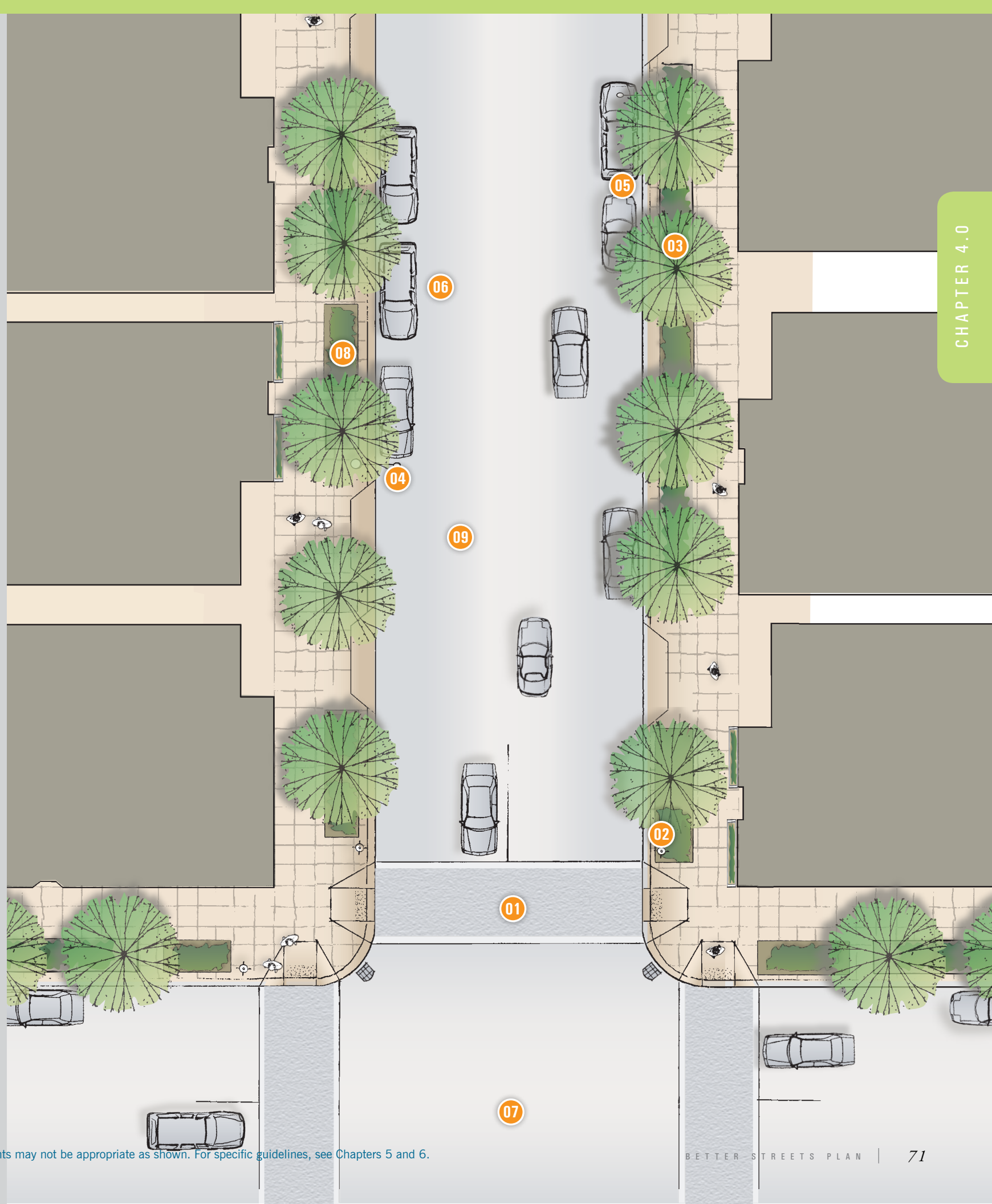
**07**  
Traffic  
circle (5.7)



**08**  
Sidewalk  
or median  
pocket park  
(5.8)



**09**  
Shared  
public way  
(5.8)



\*\*Site plans in this chapter are for representational puposes only; individual elements may not be appropriate as shown. For specific guidelines, see Chapters 5 and 6.

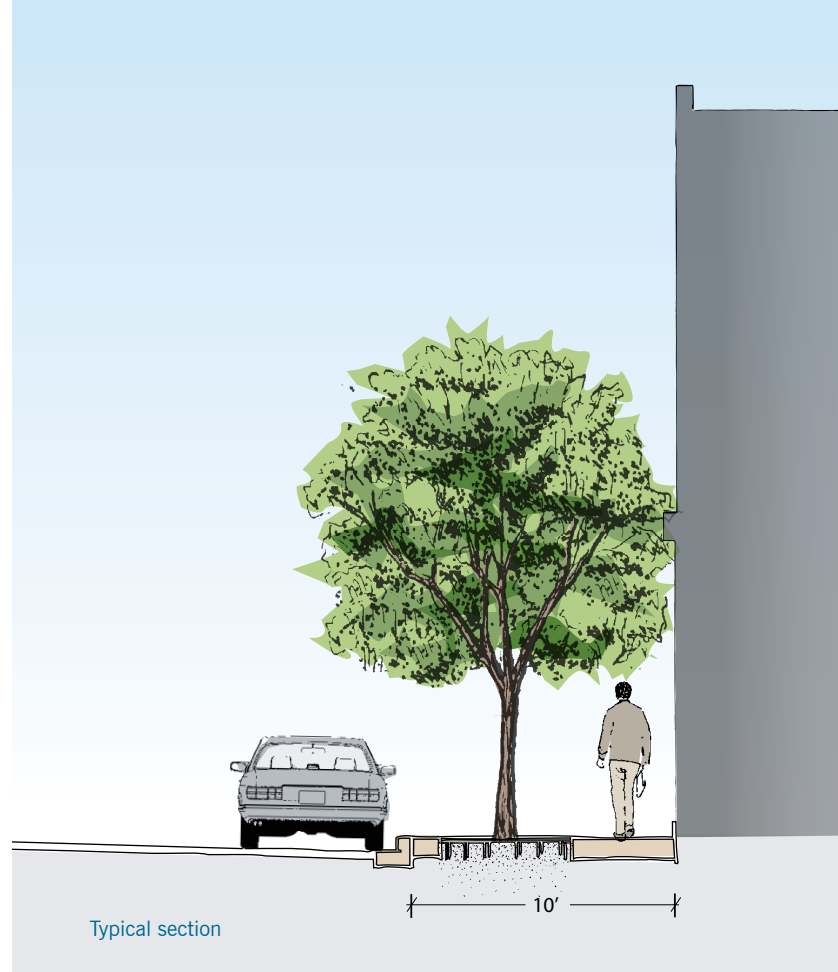
# Industrial

Industrial streets are defined by large-scale production, distribution, and repair facilities that have an assortment of challenging impacts on streetscape character. These streets typically have a less active street frontage punctuated by large driveways, loading docks, and other auto-serving facilities, and front on wide streets that accommodate large trucks. Sidewalks and streetscape amenities are often minimal.

While these streets must serve heavy trucks and loading functions, they should also consider the pedestrian realm for workers and others passing through.

## Considerations

- Access needs for local businesses, including loading activities and heavy trucks
- Relatively low pedestrian volumes; however, need for pedestrian safety and comfort in challenging environment
- Need for public spaces for workers to take breaks



- ▲ Industrial streets must serve major freight and loading activities, but should still have a safe and comfortable pedestrian realm

## Standard Improvements



Curb ramps  
(5.1)



Street trees  
(6.1)



Stormwater  
control measures  
(6.2)

## Additional Guidelines

- Industrial streets should use property line plantings and street trees where trees are not possible adjacent to the curb
- For specific stormwater control measures, see Section 6.2.



## Case by Case Additions



**01**  
Extended  
bulb-out  
(5.2)



**02**  
Mid-block  
bulb-out (5.2)



**03**  
Center  
median (5.4)



**04**  
Transit bulb-  
out or boarding  
island (5.5)



**05**  
Perpendicular  
or angle  
parking (5.6)



\*\*Site plans in this chapter are for representational purposes only; individual elements may not be appropriate as shown. For specific guidelines, see Chapters 5 and 6.

# Mixed-Use

Mixed-use streets such as those in SoMa or Showplace Square serve a variety of low-intensity industrial uses, as well as a growing number of residences, shops, and services. Their use and character are in a state of constant change, and streets must reflect this changing character and serve a variety of needs. Mixed use streets are often wide streets, with high volumes of fast-moving traffic.

Streetscape treatments should include landscaping, pedestrian safety elements, public space uses, and other amenities to complement current and future land use.

## Considerations

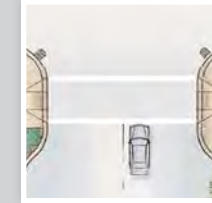
- Access needs for local businesses, including loading activities and light trucks
- High volume and speed of through traffic
- Need for increased public open space
- Need for improved pedestrian buffering from through traffic
- Need for flexibility to accommodate changing uses



▲ Industrial mixed-use streets serve a changing mix of land uses

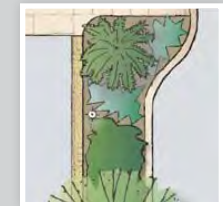
## Standard Improvements

Marked crosswalks with curb ramps (Section 5.1)



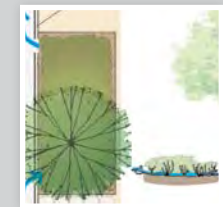
Street trees (6.1)

Pedestrian signals (countdown and APS) (5.2)



Sidewalk planters (6.1)

Corner curb extensions (5.2)



Stormwater control measures (6.2)

## Additional Guidelines

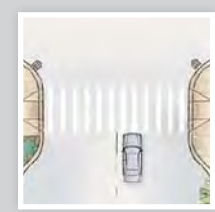
- Tree grates, pedestrian lighting, special paving in the furnishings zone and site furnishings should be considered in high pedestrian volume areas, or where capital and maintenance budgets allow.
- For specific stormwater control measures, see Section 6.2.



Case by Case Additions



01 Mid-block crossing (5.1)



02 High visibility crosswalks (5.1)



03 Special crossing treatments (warning signs, beacons, etc.) (5.1)



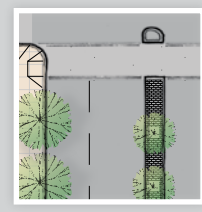
04 Extended bulb-out (5.2)



05 Mid-block bulb-out (5.2)



06 Center median (5.4)



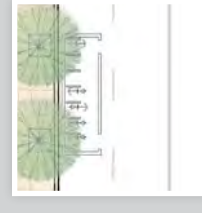
07 Pedestrian refuge island (5.4)



08 Transit bulb-out or boarding island (5.5)



09 Perpendicular or angle parking (5.6)



10 Flexible use of parking lane (5.6)



11 Parking lane planters (5.6)



12 Sidewalk pocket park (5.8)



13 Boulevard treatment (5.8)



\*\*Site plans in this chapter are for representational puposes only; individual elements may not be appropriate as shown. For specific guidelines, see Chapters 5 and 6.

# Parkways

Parkways, such as Dolores, Park Presidio, Brotherhood Way, and the Great Highway have broad well-landscaped medians and sidewalks that provide recreational paths, while moving vehicles, bikes, and pedestrians across the city. These streets can function not only as transportation corridors, but also as linear parks, creating a green network.

This green spaces can often be more effectively used for pedestrian, open space, and ecological functions, by providing multi-use trails, seating, open space, and stormwater management.

## Considerations

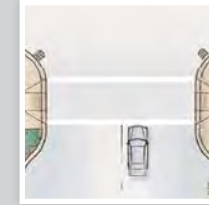
- High volume and speed of through traffic
- Desire for generous pedestrian environment and public realm
- Opportunity to provide recreational amenities
- Opportunity to provide ecological functioning
- Few access points and driveways
- Opportunity to connect/be part of regional trails such as the Bay Trail



- ▲ Parkways are characterized by large landscaped medians or frontages which could often be better used for recreational or ecological purposes

## Standard Improvements

Marked crosswalks with curb ramps (Section 5.1)



Sidewalk planters—continuous planting strip (6.1)



Pedestrian signals (countdown and APS) (5.2)



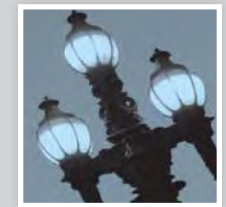
Stormwater control measures (6.2)



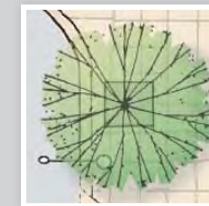
Corner curb extensions (5.2)



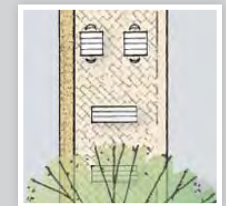
Pedestrian-scale lighting (6.3)



Street trees (6.1)



Site furnishings (6.5)



## Additional Guidelines

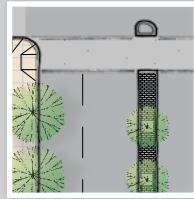
- Parkway should include recreational spaces such as jogging paths in existing green spaces as width allows.
- For specific stormwater control measures, see Section 6.2.



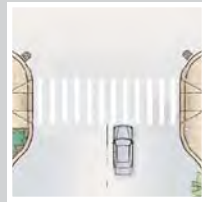
Case by Case Additions



**01**  
Mid-block crossing (5.1)



**07**  
Pedestrian refuge island (5.4)



**02**  
High visibility crosswalks (5.1)



**08**  
Transit bulb-out or boarding island (5.5)



**03**  
Special crossing treatments (warning signs, beacons, etc.) (5.1)



**09**  
Perpendicular or angle parking (5.6)



**04**  
Extended bulb-out (5.2)



**10**  
Sidewalk or median pocket park (5.8)



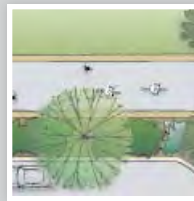
**05**  
Mid-block bulb-out (5.2)



**11**  
Boulevard treatment (5.8)



**06**  
Center median (5.4)



**12**  
Multi-Use path



\*\*Site plans in this chapter are for representational puposes only; individual elements may not be appropriate as shown. For specific guidelines, see Chapters 5 and 6.



# Park Edge Streets

Streets that border major parks or the waterfront have one set of conditions on one side of the street and a distinctly different set of conditions on the other. Park edge streets often have fewer spatial constraints on the park edge side but unique demands of high pedestrian volumes or special activities associated with them. These streets should have a generous park edge with landscaping, lighting, furnishings, and multi-use trails.

## Considerations

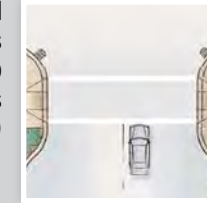
- High volume and speed of through traffic
- Desire for generous pedestrian environment and public realm
- Opportunity to provide recreational amenities
- Opportunity to provide ecological functioning
- Few access points and driveways
- Different conditions on opposite sides of the street
- Opportunity to connect/be part of regional trails such as the Bay Trail



- ▲ Park edge streets, adjacent to the City's parks and waterfront, present opportunities for significant recreational uses, landscaping, and ecological functioning

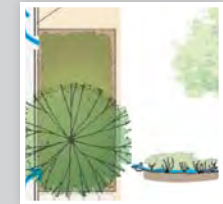
## Standard Improvements

Marked crosswalks with curb ramps (Section 5.1)



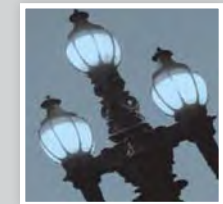
Sidewalk planters—continuous planting strip (6.1)

Pedestrian signals (countdown and APS) (5.2)



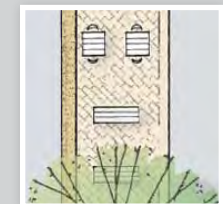
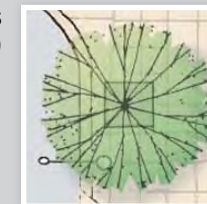
Stormwater control measures (6.2)

Corner curb extensions (5.2)



Pedestrian-scale lighting (6.3)

Street trees (6.1)



Site furnishings (6.5)

## Additional Guidelines

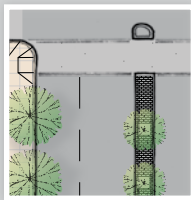
- Park edge streets should include recreational spaces such as jogging paths in existing green spaces
- For specific stormwater control measures, see Section 6.2.



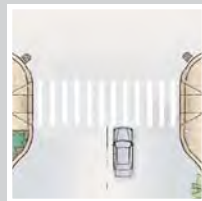
Case by Case Additions



**01**  
Mid-block crossing (5.1)



**07**  
Pedestrian refuge island (5.4)



**02**  
High visibility crosswalks (5.1)



**08**  
Transit bulb-out or boarding island (5.5)



**03**  
Special crossing treatments (warning signs, beacons, etc.) (5.1)



**09**  
Perpendicular or angle parking (5.6)



**04**  
Extended bulb-out (5.2)



**10**  
Sidewalk or median pocket park (5.8)



**05**  
Mid-block bulb-out (5.2)



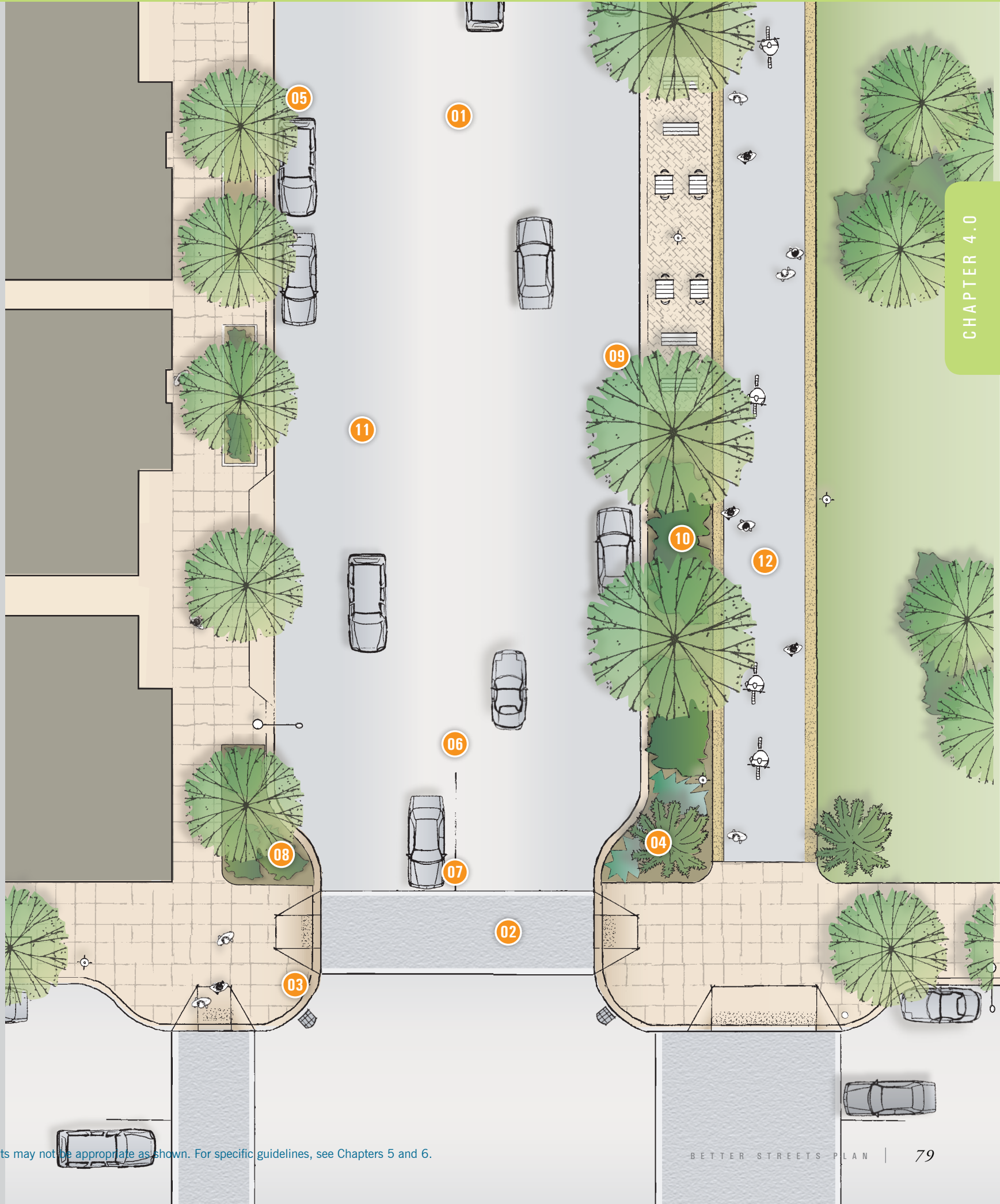
**11**  
Boulevard treatment (5.8)



**06**  
Center median (5.4)



**12**  
Multi-Use path



\*\*Site plans in this chapter are for representational puposes only; individual elements may not be appropriate as shown. For specific guidelines, see Chapters 5 and 6.



# Boulevards

Multi-way boulevards such as Octavia Boulevard separate through travel lanes from local access lanes to simultaneously move vehicles while providing a calm, spacious pedestrian and living environment for adjacent residences. Boulevards should be considered on existing or new streets where opportunities exist for substantial street development or redevelopment and width allows.



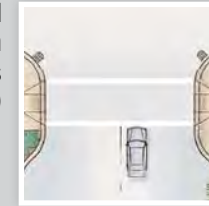
- ▲ Boulevards move high traffic volumes while creating a generous pedestrian realm and living environment by separating through traffic from local access lanes

## Considerations

- High volumes of through traffic separated from local access
- Desire to create generous pedestrian realm by calming traffic and maximizing pedestrian space on local lanes
- Opportunity to provide recreational amenities
- Opportunity to provide ecological functioning
- Requires sufficient street width

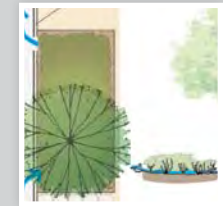
## Standard Improvements

Marked crosswalks with curb ramps (Section 5.1)



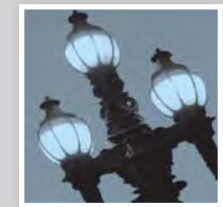
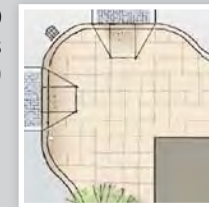
Sidewalk planters (6.1)

Pedestrian signals (countdown and APS) (5.2)



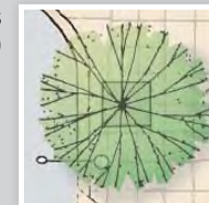
Stormwater control measures (6.2)

Corner curb extensions (5.2)

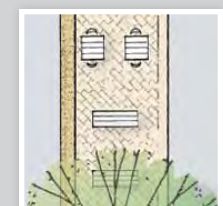


Pedestrian-scale lighting (6.3)

Street trees (6.1)



Special paving in furnishings zone (6.4)



Site furnishings (6.5)

## Additional Guidelines

- Tree grates should be considered in high pedestrian volume areas, or where capital and maintenance budgets allow.
- Side lanes should be designed to prioritize pedestrian use and calm traffic; they may include features such as shared public ways or raised crosswalks.
- Boulevards should follow the guidance in Section 5.8.
- For specific stormwater control measures, see Section 6.2.



Case by Case Additions



**01**  
Raised crossing  
—at side  
access lanes  
(5.1)



**02**  
High visibility  
crosswalks  
(5.1)



**03**  
Special crossing  
treatments  
(warning signs,  
beacons, etc.  
(5.1)



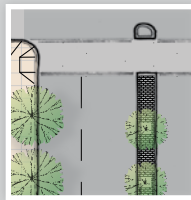
**04**  
Extended  
bulb-out  
(5.2)



**05**  
Mid-block  
bulb-out  
(5.2)



**06**  
Center  
median  
(5.4)



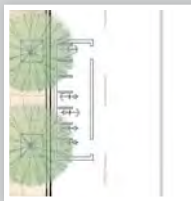
**07**  
Pedestrian  
refuge island  
(5.4)



**08**  
Transit  
boarding  
island at side  
medians (5.5)



**09**  
Perpendicular  
or angle  
parking (5.6)



**10**  
Flexible use of  
parking lane  
(5.6)



**11**  
Parking lane  
planters  
(5.6)



**12**  
Sidewalk  
pocket park  
(5.8)



**13**  
Shared public  
way - at side  
access lanes  
(5.8)



\*\*Site plans in this chapter are for representational puposes only; individual elements may not be appropriate as shown. For specific guidelines, see Chapters 5 and 6.



# Ceremonial (Civic) Streets

Ceremonial streets such as Market Street, Fulton Street, and the Embarcadero are grand civic spaces which serve as major gathering spots for marches, parades, and rallies, and serve as world renowned public spaces and attractions.

Ceremonial streets should be uniquely designed in each case; they should exhibit a high degree of design consistency, formality, and care.



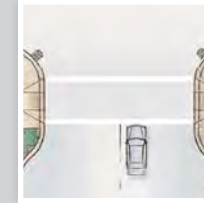
▲ Ceremonial streets are the civic heart of the City

## Considerations

- High visibility and citywide role
- High levels of pedestrian activity, transit service, and other travel modes
- Need to create distinct public realm that can be used for rallies, parades, marches, and the like.

## Standard Improvements

Marked crosswalks with curb ramps (Section 5.1)



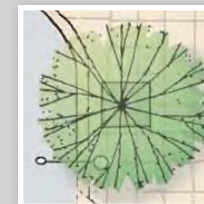
Pedestrian signals (countdown and APS) (5.2)



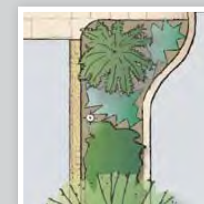
Corner curb extensions (5.2)



Street trees (6.1)



Sidewalk planters (planter boxes) (6.1)



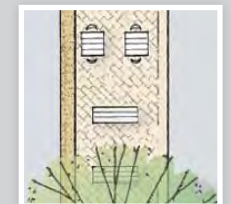
Stormwater control measures (6.2)



Pedestrian-scale lighting (6.3)



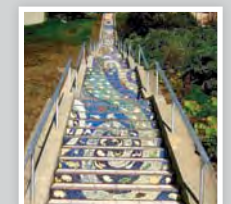
Special paving (6.4)



Site furnishings (6.5)



Wayfinding signage (6.5)



Public art (6.5)

## Additional Guidelines

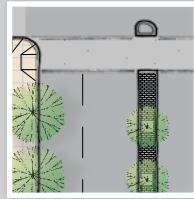
- Ceremonial streets are special streets, and should have unique, high-quality designs
- Ceremonial streets should use consistent, unique plantings, lighting, furnishings, and paving treatments
- Ceremonial streets should have generous pedestrian and public spaces
- For specific stormwater control measures, see Section 6.2.



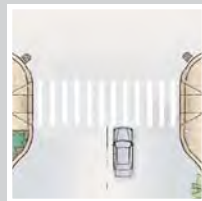
### Case by Case Additions



**01**  
Mid-block crossing (5.1)



**07**  
Pedestrian refuge island (5.4)



**02**  
High visibility crosswalks (5.1)



**08**  
Transit bulb-out or boarding island (5.5)



**03**  
Special crossing treatments (warning signs, beacons, etc.) (5.1)



**09**  
Perpendicular or angle parking (5.6)



**04**  
Extended bulb-out (5.2)



**10**  
Sidewalk or median pocket park (5.8)



**05**  
Mid-block bulb-out (5.2)



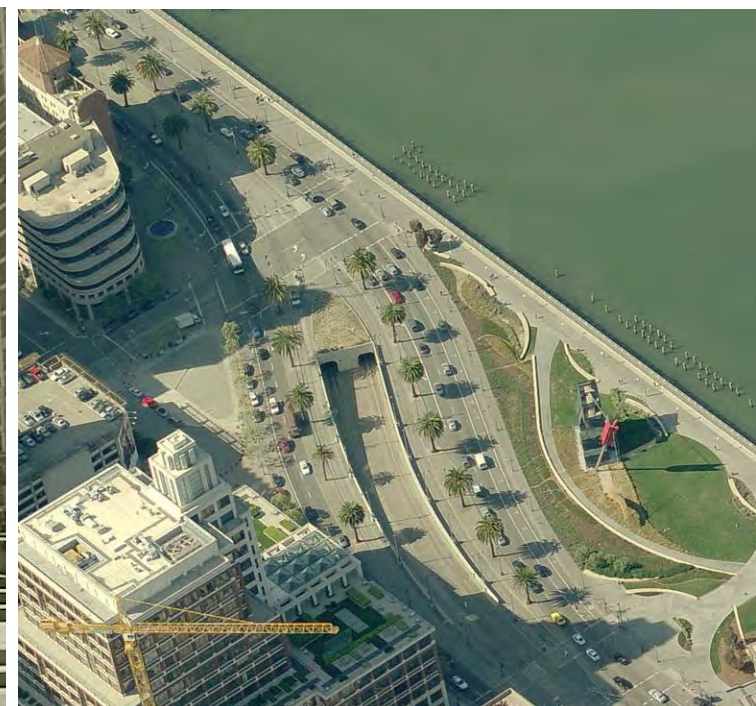
**11**  
Boulevard treatment (5.8)



**06**  
Center median (5.4)



**12**  
Pedestrian-only street (5.8)



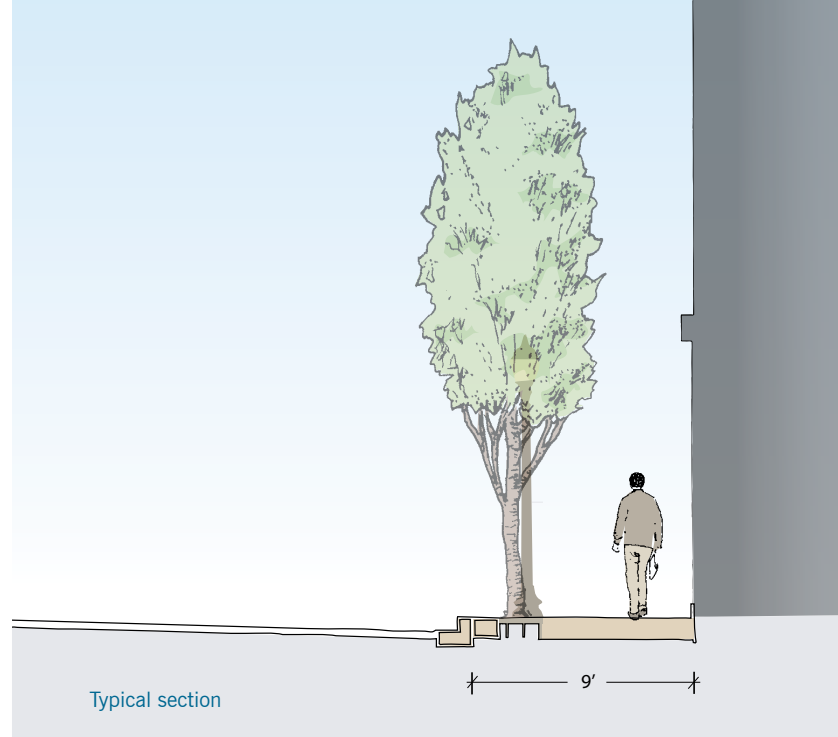
\*\*Site plans in this chapter are for representational purposes only; individual elements may not be appropriate as shown. For specific guidelines, see Chapters 5 and 6.



# Alleys

Alleys are small-scale streets that typically only carry low numbers of vehicles accessing adjacent properties. Their character varies across the city, from residential to service alleys.

Alleys should be designed to a pedestrian-scale speed and level of detail wherever possible, to calm traffic and emphasize pedestrian use. Alleys may also include seating, landscaping, and pedestrian lighting to create usable public spaces.

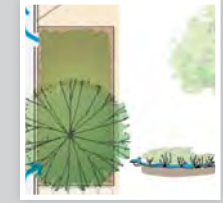


## Considerations

- Low vehicle speeds and volumes
- Desire to create generous pedestrian realm through designs that emphasize shared space
- Narrow right-of-way; limited sidewalk space
- Need for service access to adjacent businesses and residences

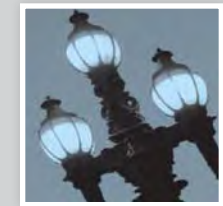
## Standard Improvements

Curb ramps  
—where not shared public way or raised crosswalk (5.1)



Stormwater control measures (6.2)

Street trees (6.1)



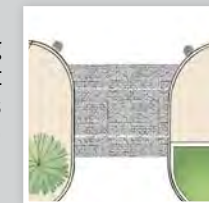
Pedestrian-scale lighting (6.3)

Sidewalk planters (6.1)



Special paving (entire roadway) (6.4)

Raised crossing  
— at intersections (5.1)



## Additional Guidelines

- Alleys should be designed as shared public ways wherever possible. See next page.
- Where alleys are not designed as shared public ways, they should incorporate raised crossings across the alley entrance and special paving across the entire right-of-way wherever possible.
- Tree grates and site furnishings should be considered in high pedestrian volume areas, or as capital and maintenance budgets allow.
- For specific stormwater control measures, see Section 6.2.



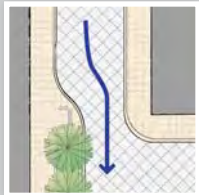
### Case by Case Additions



**01**  
Mid-block  
bulb-out  
(5.2)



**02**  
Extended  
bulb-out  
(5.2)



**03**  
Chicane  
(5.7)



**04**  
Parking lane  
planters (5.6)



**05**  
Shared  
public way  
(5.8)



**06**  
Pocket  
park (5.8)



**07**  
Pedestrian-only  
street (5.8)

Alley as  
standard  
street. ▶

SEE ALSO  
SHARED  
PUBLIC WAY,  
NEXT PAGE



\*\*Site plans in this chapter are for representational puposes only; individual elements may not be appropriate as shown. For specific guidelines, see Chapters 5 and 6.

# Shared Public Ways

Shared public ways are small-scale, single-surface streets that prioritize pedestrian use, but permit vehicles and bicycles to share the open space.

Shared public ways should be designed to emphasize their pedestrian scale and calm traffic. They enable a generous pedestrian realm on narrow streets, and they create pockets of usable open space to act as front yards in open space-deficient neighborhoods.

## Considerations

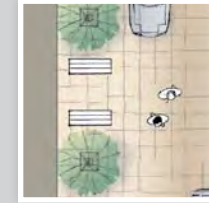
- Desire to create generous pedestrian realm through designs that emphasize shared space
- Low vehicle speeds and volumes
- Need for service access to adjacent businesses and residences
- Need to provide visual cues to alert people with visual impairments to the shared nature of the space



▲ Hotaling Street

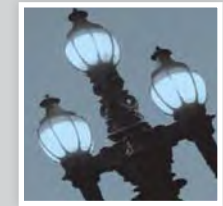
## Standard Improvements

Single-surface paving treatment (5.8)



Stormwater control measures (6.2)

Street trees (6.1)

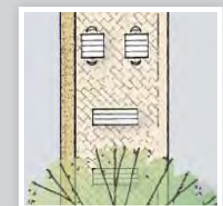


Pedestrian-scale lighting (6.3)

Sidewalk planters (6.1)



Special paving (6.4)



Site furnishings (6.5)

## Additional Guidelines

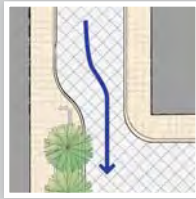
- See Section 5.8 for specific Shared public way guidelines
- Shared public ways should incorporate raised crossings across the alley entrance and special paving across the entire right-of-way wherever possible.
- Tree grates and site furnishings should be considered in high pedestrian volume areas, or as capital and maintenance budgets allow.
- For specific stormwater control measures, see Section 6.2.



## Case by Case Additions



**01**  
Raised crossing—  
at entrance  
(5.1)



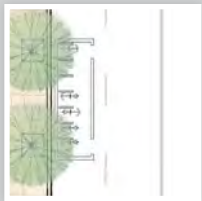
**05**  
Chicane  
(5.7)



**02**  
Perpendicular  
or angle  
parking (5.6)



**06**  
Pocket  
park (5.8)



**03**  
Flexible use  
of parking  
lane (5.6)



**07**  
Multi-Use  
path



**04**  
Parking lane  
planters  
(5.6)

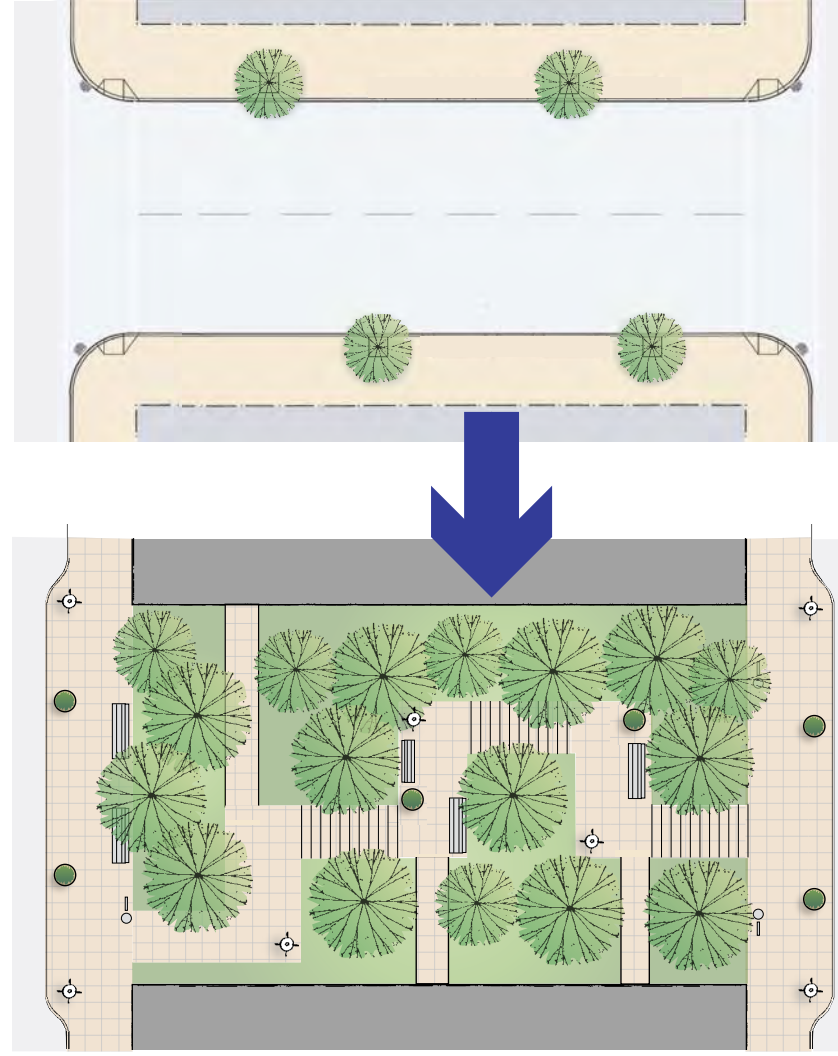


\*\*Site plans in this chapter are for representational purposes only; individual elements may not be appropriate as shown. For specific guidelines, see Chapters 5 and 6.

# Paseos

Paseos are pedestrian only rights-of-way, whether a public staircase, a narrow pedestrian path, or a downtown alley connecting two streets. As with alleys, paseos should be designed to a pedestrian scale with various amenities and pedestrian-oriented spaces.

As each is unique to its context, recommended improvements reflect broad categories of improvements that can be specifically tailored to a particular context.



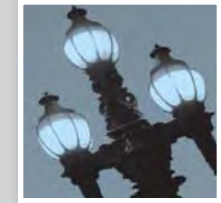
▲ Conversion of steep underutilized street to stairs/trails

## Considerations

- No vehicle traffic
- Desire to create generous pedestrian realm
- Need to ensure emergency and maintenance vehicle access as appropriate
- Social and maintenance considerations

## Standard Improvements

Street trees (6.1)



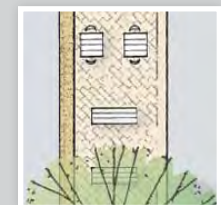
Pedestrian-scale lighting (6.3)

Sidewalk planters (6.1)



Special paving — entire right-of-way (6.4)

Stormwater control measures (6.2)



Site furnishings (6.5)

## Additional Guidelines

- Tree grates should be considered in high pedestrian volume areas, or as capital and maintenance budgets allow.
- For specific stormwater control measures, see Section 6.2.



## Case by Case Additions



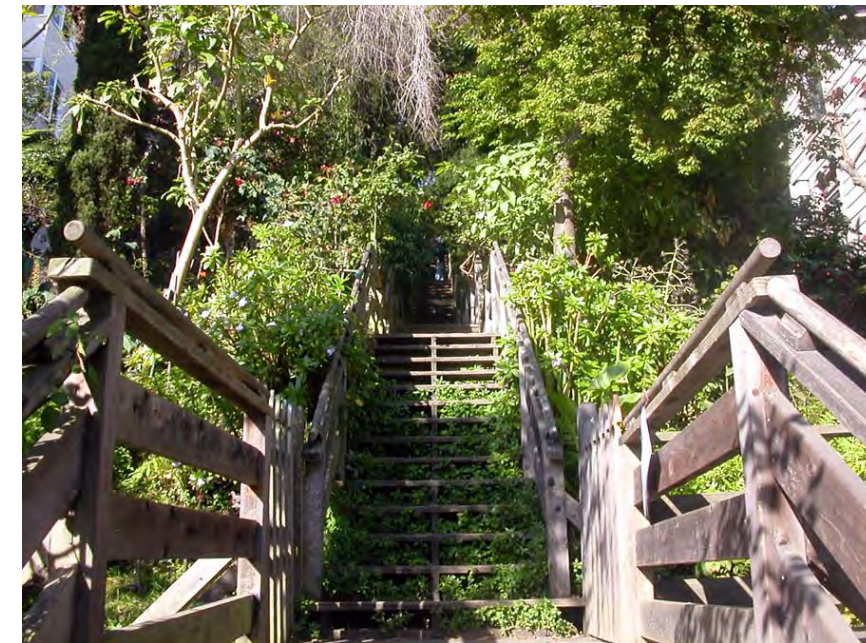
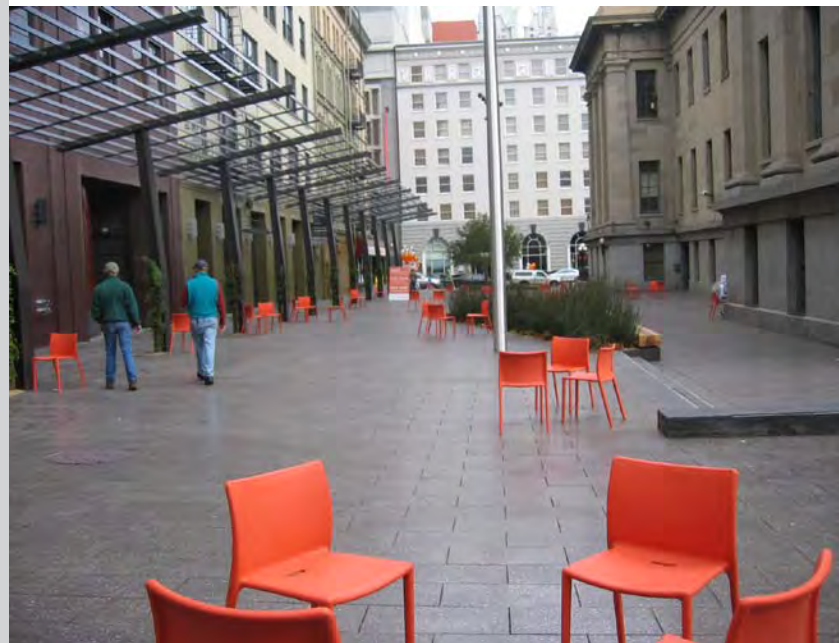
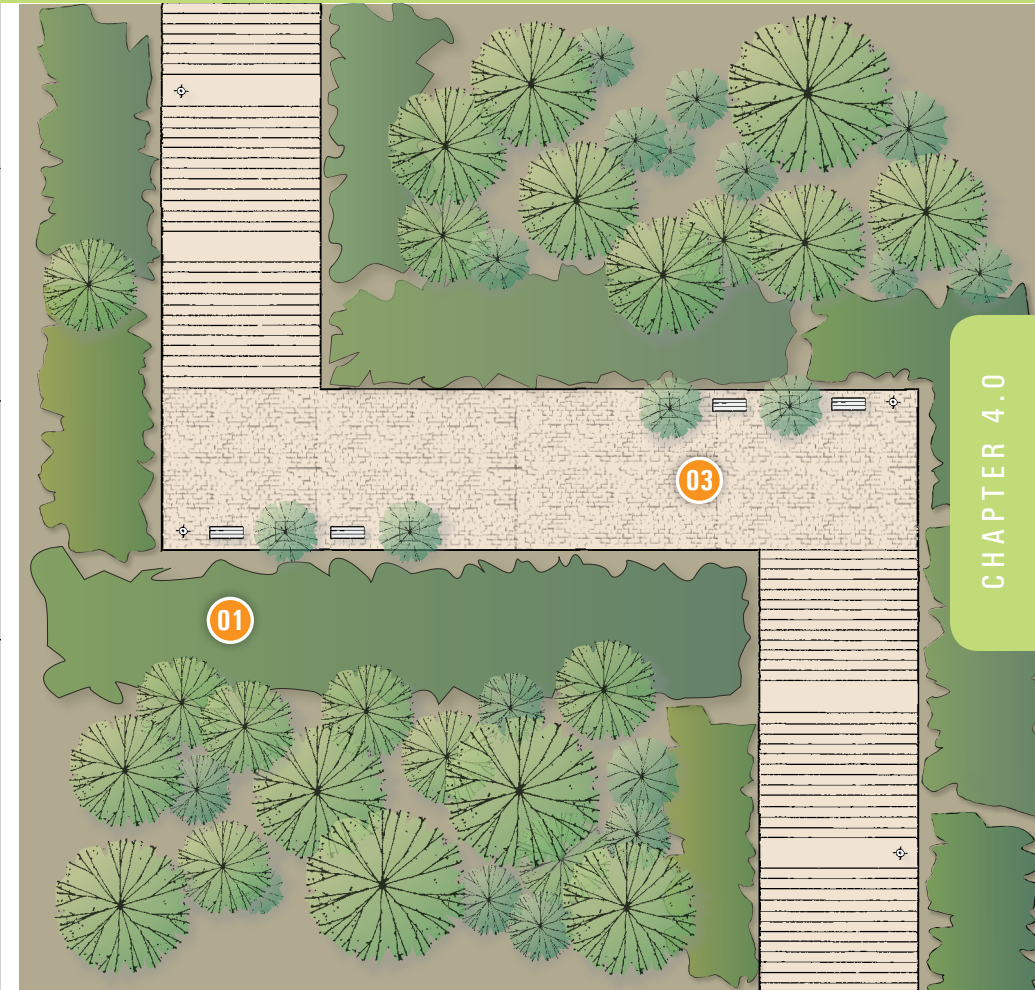
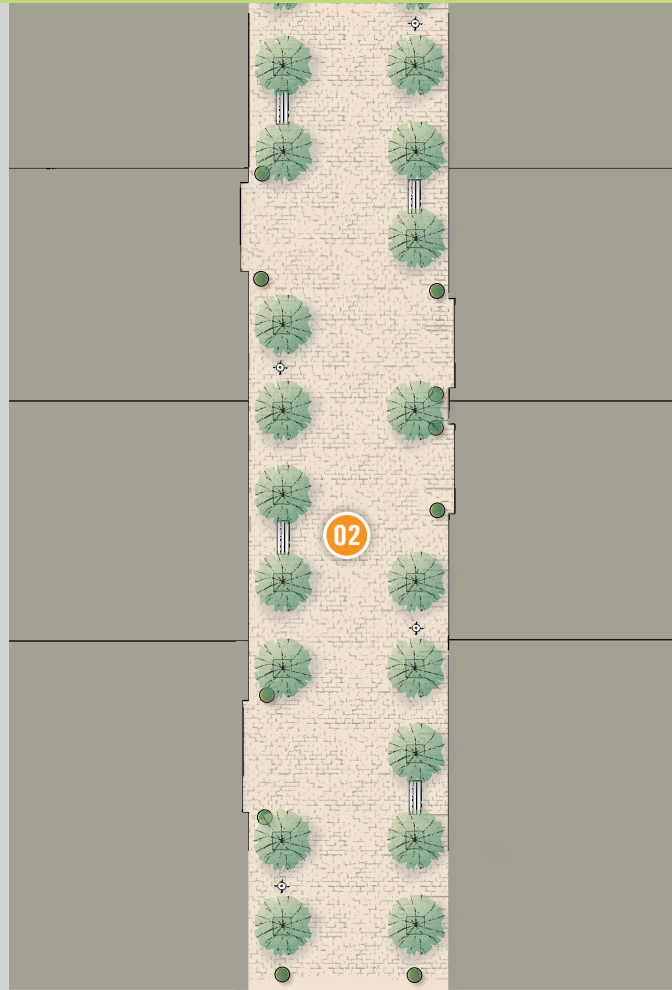
**01**  
Pocket park  
(5.8)



**02**  
Pedestrian-  
only street  
(5.8)



**03**  
Multi-Use  
path



▲ Paseos are pedestrian-only pathways that provide opportunities to create unique public spaces

STANDARD IMPROVEMENTS BY STREET TYPE

	Curb Ramps (5.1)	Marked Crosswalks (5.1)	Ped signals –countdown and APS (5.1)	Corner curb extensions (5.2)	Street Trees (6.1)	Tree Grates (6.1)	Sidewalk Planters (6.1)	Stormwater Control (6.2)	Pedestrian Lighting (6.3)	Special Paving (6.4)	Site Furnishings (6.5)
<b>Downtown Commercial</b> <i>see Downtown Streetscape Plan</i>	Y	Y	Y	Y	Y	Y	Y - planter box	Y	Y	Y	Y
<b>Commercial Thoroughway</b>	Y	Y	Y	Y	Y	M	Y - planter box	Y	Y	Y - furnishings zone	Y
<b>Neighborhood Commercial</b>	Y	Y	Y	Y	Y	M	Y - planter box	Y	Y	Y - furnishings zone	Y
<b>Downtown Residential</b>	Y	Y	Y	Y	Y	M	Y	Y	Y	Y - furnishings zone	Y
<b>Residential Thoroughway</b>	Y	Y	Y	Y	Y	N	Y	Y	Y - at corners	N	M
<b>Neighborhood Residential</b>	Y	M	M	M	Y	N	Y - planter strip	Y	Y - at corners	N	N
<b>Industrial</b>	Y	M	M	N	Y	N	N	Y	N	N	N
<b>Mixed-Use</b>	Y	Y	Y	Y	Y	M	Y	Y	M	Y - furnishings zone	Y
<b>Parkway</b>	Y	Y	Y	Y	Y	N	Y - planter strip	Y	Y	N	Y
<b>Park Edge</b>	Y	Y	Y	Y	Y	N	Y - planter strip	Y	Y	N	Y
<b>Boulevard</b>	Y	Y	Y	Y	Y	M	Y	Y	Y	Y - furnishings zone	Y
<b>Ceremonial</b>	Y	Y	Y	Y	Y	Y	N	Y	Y	Y	Y
<b>Alley</b>	Y - prefer shared st. or raised xing	M	n/a	N	Y	M	Y	Y	Y	Y - entire r.o.w.	M
<b>Shared Public Way</b>	n/a	n/a	n/a	n/a	Y	M	Y	Y	Y	Y - entire r.o.w.	Y
<b>Paseo</b>	n/a	n/a	n/a	n/a	Y	M	Y	Y	Y	Y - entire r.o.w.	Y

NOTES:

This table describes treatments that should be considered standard improvements and added to all streetscape improvement projects.

This table is meant as a general guide; there may be cases where appropriate treatments for a particular street type are different than described in this table, depending on right-of-way width, land use, and transportation characteristics.

In some cases, including all standard improvements may be limited by available funding. Not every project need have every standard improvement; however, projects should be consolidated wherever possible to maximize ‘completeness’ of improvements.

Individual elements should follow the guidelines and criteria for appropriateness described in Chapters 5 and 6.

Key: Y = Yes M = Maybe N = No



CASE-BY-CASE ADDITIONS BY STREET TYPE

	High-visibility crosswalk (5.1)	Special crosswalk treatment (5.1)	Mid-block crossing (5.1)	Raised crossing (5.1)	Extended bulb-out (5.2)	Mid-block bulb-out (5.2)	Center median (5.4)	Pedestrian refuge island (5.4)	Transit bulb-out/boarding island (5.5)	Perp/angled parking (5.6)	Flex use of parking lane (5.6)	Parking lane planters (5.6; 6.1)	Chicane (5.7)	Traffic circle (5.7)	Pocket park (5.8)	Boulevard treatment (5.8)	Shared Public Way treatment (5.8)	Ped-only street (5.8)	Multi-use path
Downtown Commercial	Y	Y	Y	N	Y	Y	Y	Y	Y	Y	Y	N	N	N	Y	Y	N	N	N
Commercial Throughway	Y	Y	Y	N	Y	Y	Y	Y	Y	Y	Y	Y	N	N	Y	Y	N	N	N
Neighborhood Commercial	Y	Y	Y	Y	Y	Y	Y	Y	Y	Y	Y	Y	N	N	Y	N	N	N	N
Downtown Residential	Y	Y	Y	N	Y	Y	Y	Y	Y	Y	N	Y	N	N	Y	Y	N	N	N
Residential Throughway	Y	Y	Y	N	Y	Y	Y	Y	Y	Y	N	Y	N	N	Y	Y	N	N	N
Neighborhood Residential	M	M	N	Y	Y	Y	N	M	N	Y	N	Y	Y	Y	Y	N	Y	N	N
Industrial	M	M	N	N	Y	Y	Y	M	Y	Y	N	N	N	N	N	N	N	N	N
Mixed-Use	Y	Y	Y	N	Y	Y	Y	Y	Y	Y	Y	Y	N	N	Y	Y	N	N	N
Parkway	Y	Y	Y	N	Y	Y	Y	Y	Y	Y	N	N	N	N	Y	Y	N	N	Y
Park Edge	Y	Y	Y	N	Y	Y	Y	Y	Y	Y	N	N	N	N	Y	Y	N	N	Y
Boulevard	Y	Y	N	Y - local lanes	Y	Y	Y	Y	Y - side median	Y	Y	Y	N	N	Y	n/a	Y - local lanes	N	N
Ceremonial	Y	Y	Y	N	Y	Y	Y	Y	Y	Y	N	N	N	N	Y	Y	N	Y	N
Alley	N	N	N	Y - standard	Y	Y	N	N	N	N	N	Y	Y	N	Y	N	Y	Y	N
Shared Public Way	n/a	n/a	n/a	Y - standard	n/a	n/a	n/a	n/a	n/a	Y	Y	Y	Y	n/a	Y	n/a	Y	N	Y
Paseo	n/a	n/a	n/a	n/a	n/a	n/a	n/a	n/a	n/a	n/a	n/a	n/a	n/a	n/a	Y	n/a	n/a	Y	Y

NOTES:

These guidelines indicate treatments that are generally appropriate for various street types on a case-by-case basis. These treatments should be added to projects as capital and maintenance budgets, physical constraints, and neighborhood preferences allow. These treatments should generally be considered above and beyond standard treatments, and not included for all improvement projects.

This table is meant as a general guide; there may be cases where appropriate treatments for a particular street type are different than described in this table, depending on right-of-way width, land use, and transportation characteristics.

Individual elements should follow the guidelines and criteria for appropriateness described in Chapters 5 and 6.

Key: Y = Yes M = Maybe N = No

# Overall Streetscape Guidelines

## 4.2

Streetscapes should reflect a unified, complete design that balances among a wide variety of functions, including stormwater management, safe pedestrian travel, use as public space, bicycle, transit, and vehicle movement, parking and loading requirements, ease of maintenance, and emergency access. Wherever possible, the City should coordinate street improvement projects to make related improvements simultaneously to construct holistically designed street improvements.

All streetscape projects should follow the following guidelines:

- Wherever possible, streetscape improvements should be constructed for an entire corridor on both sides of the block for design consistency. At minimum, they should be constructed at least the length of one block.
- Street improvement projects should widen sidewalks that don't meet the recommended sidewalk widths (in this section) as feasible.

▼ Maiden Lane

### → In this section: Overall Streetscape Guidelines

- General guidelines
- Intersection design
- Sidewalk width and zones
- Streetscape layout

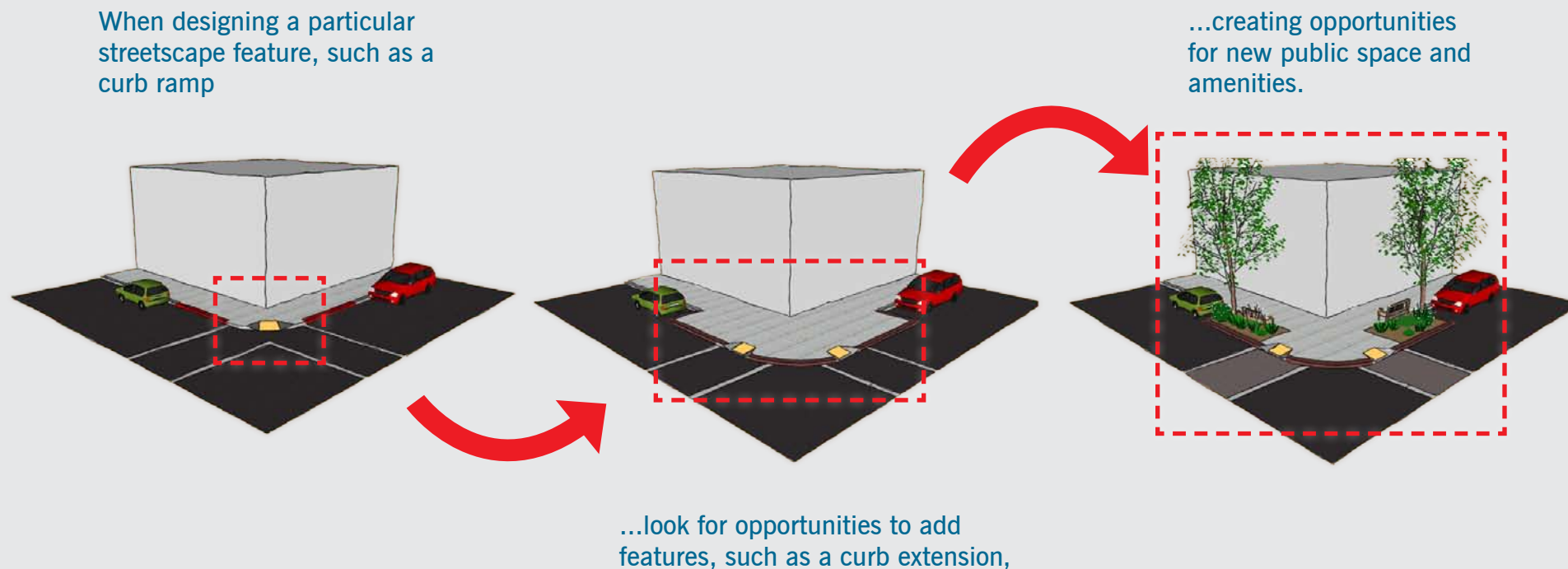




- Sidewalk repair, utility trenching, and other sidewalk excavations should add street trees, landscaping, and stormwater facilities, and site furnishings as feasible.
- Traffic calming projects that add medians, chicanes, circles, or the like, should add trees, landscaping, stormwater facilities, and site furnishings as feasible.
- Curb ramp construction projects should include curb extensions as feasible.
- Roadway lighting upgrades should add pedestrian-oriented lighting as feasible.

- Streetscape improvement projects should consolidate utilities, parking meters, and street signs and poles as feasible.
- All streetscape projects should include stormwater control measures per Section 6.2 and the San Francisco Stormwater Design Guidelines.
- All streetscape improvement projects that create new structures in the right-of-way must include public art per San Francisco Administrative Code Section 3.19 (Public Art Ordinance).

In addition, streetscape projects should follow the guidelines in the following sections for intersection design, sidewalk widths, sidewalk zones, and streetscape layout.



# Intersection Design

Many factors influence pedestrian safety and quality at intersections. Street width, intersection geometry, signal timing, and the frequency of crossing opportunities all play important roles in achieving a pedestrian-friendly environment.

## DESIGN PRINCIPLES

Intersections should be designed to promote pedestrian safety and comfort. Good intersections:

- encourage people to walk by creating a safe and inviting pedestrian realm;
- minimize pedestrian crossing distance, time and exposure to potential conflicts;
- maximize pedestrian visibility while providing design treatments that slow vehicles;
- slow traffic to allow drivers more reaction time and decrease severity when collisions do occur; and
- appropriately reflect the street and transportation context.

## DESIGN FEATURES

Specific features of pedestrian-friendly intersections include (shown in Figure 4.2):

### *Visible crosswalks (See Section 5.1)*

Well-marked, visible crossings should be provided to alert drivers to the fact that they are approaching a location where they may encounter crossing pedestrians. In some cases, raised or colored crossings may be appropriate.

### *Parking restrictions at corners (5.1)*

Restricting parking adjacent to corners makes pedestrians and vehicles approaching intersections more visible to one another.

### *Crossing aids (5.1)*

Accessible pedestrian facilities such as curb ramps and accessible pedestrian signals should be provided.

### *Tight curb radii (5.2)*

Curb radii for turning vehicles should be minimized to shorten crossing distances, increase pedestrian visibility, and slow turning traffic.

### *Curb extensions (5.3)*

The installation of curb extensions should be considered in areas with high pedestrian volumes to reduce crossing times, increase pedestrian visibility, and slow turning traffic.

### *Median refuges (5.4)*

Where medians are present or space otherwise exists, median refuges should be provided up to the crosswalk to provide a space for crossing pedestrians who may not be able to cross the entire roadway before the end of the walk phase.

### *Traffic calming features (5.7)*

Intersections may contain traffic calming features such as traffic circles to slow vehicles and enhance neighborhood character.



▲ Intersections are potential conflict zones between pedestrians and motor vehicles. Their design should ensure a safe and comfortable environment for those trying to cross the street.

### *Roadway and pedestrian lighting (6.3)*

Intersections should be well-lit at night to improve visibility for all users. Sufficient lighting to illuminate crossing pedestrians should be provided.

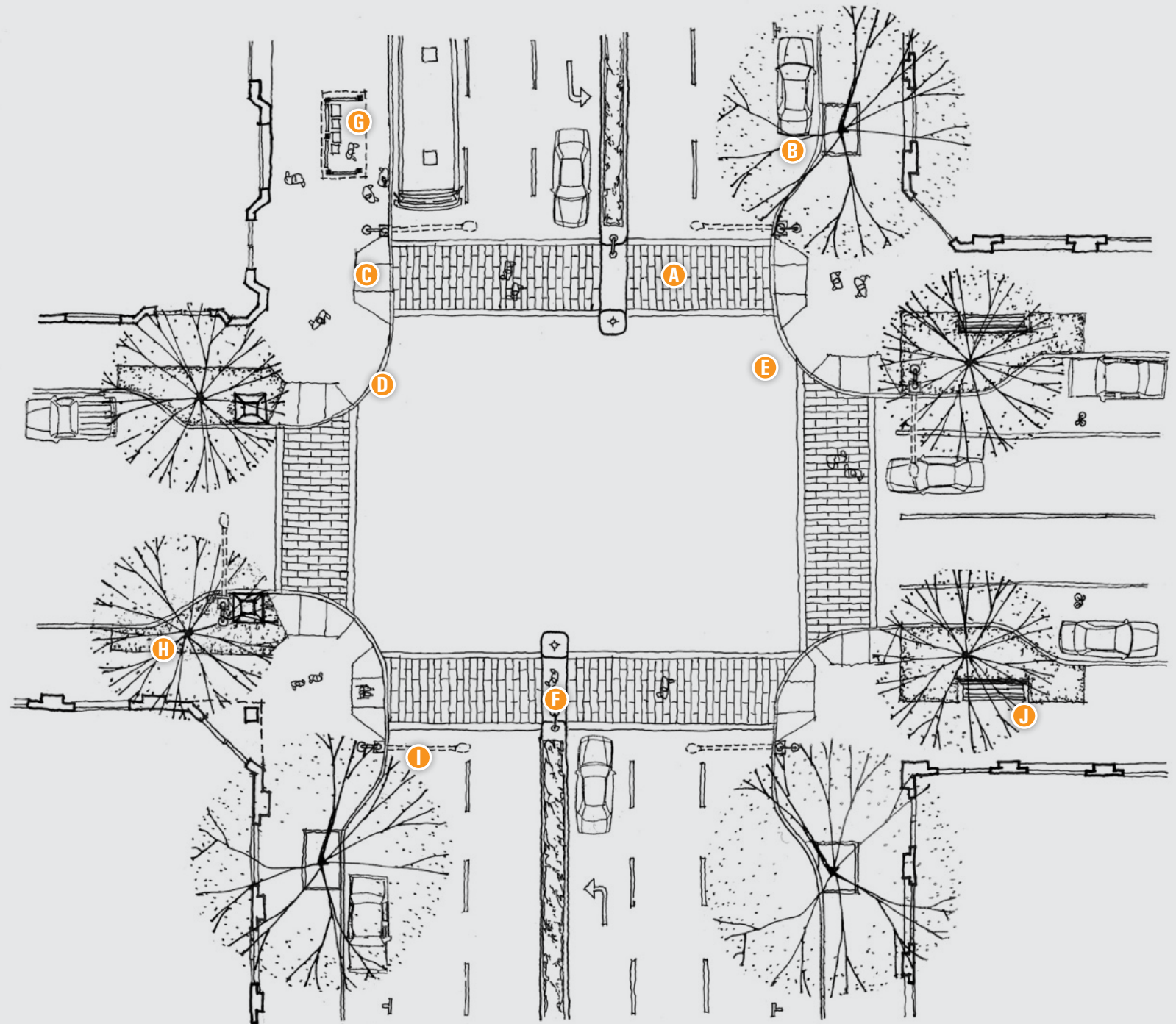
### *Streetscape elements (Chapter 6)*

Streetscape elements, including trees, plantings, and seating should be provided adjacent to intersections to enhance the character and quality of the public realm and the sense of an intersection as an important public space.



**FIGURE 4.2**  
**ELEMENTS OF A GOOD INTERSECTION**

- A. Visible crosswalks (See Section 5.1)
- B. Parking restrictions at corners (5.1)
- C. Curb ramps (5.1)
- D. Tight curb radii (5.2)
- E. Curb extensions (Section 5.3)
- F. Pedestrian refuge islands (5.4)
- G. Accessible transit stops (5.5)
- H. Street trees and landscaping (6.1)
- I. Street and pedestrian lighting (6.3)
- J. Seating and other site furnishings (6.5)



Good intersection design provides a number of pedestrian-oriented features, such as well-marked crossings and curb extensions



### 🕒 Guidelines for Non-Right-Angle Intersections

The majority of guidelines and diagrams in this document describe conditions for standard right-angle intersections. However, San Francisco's network of streets has several existing conditions that result in non-standard, skewed intersections: offset street grids that intersect one another, streets that cut through the prevailing grid at an angle, and intersections where more than two streets come together. Though most guidelines in this document apply equally at right-angle as well as at non-right-angle intersections, skewed intersections merit additional considerations as described here.

Special considerations for non-right-angle intersections include:

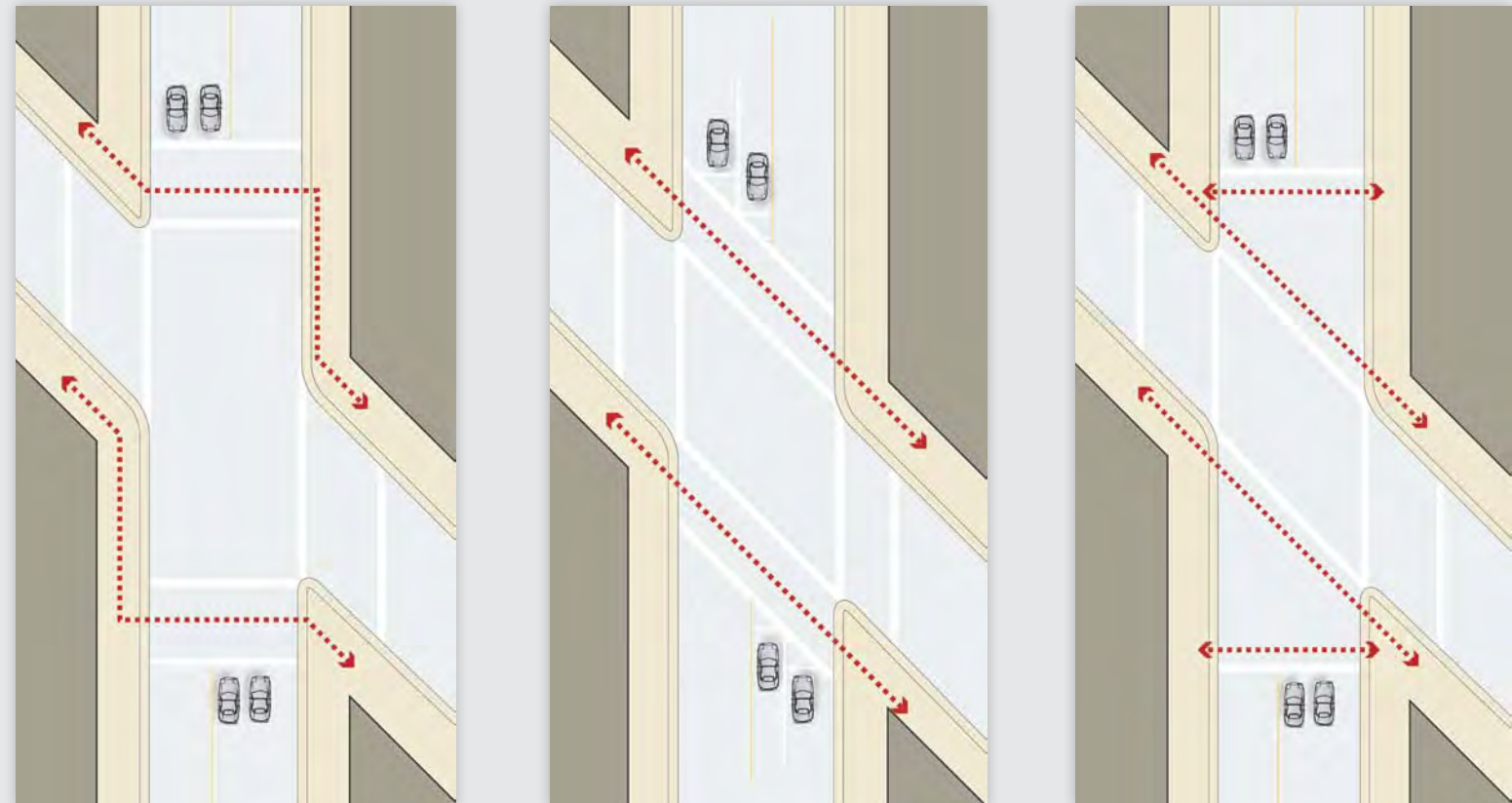
**Visibility at crossings.** One of the main safety factors at skewed intersections is lateral visibility. Drivers making acute turns have difficulty looking back at oncoming traffic to select an adequate gap. Because head and

neck mobility commonly declines as people age, acute corners pose particular challenges and potential hazards for older drivers. Design features to mitigate the effects of skew include adding traffic controls such as all-way stop signs or traffic signals and/or geometric improvements to improve corner sight distance. Geometric countermeasures are generally the most effective approach to improving safety at skewed-angle intersections, but they may entail significant construction costs.

**Crosswalks/directionality.** Crosswalks at non-right angle intersections should normally follow the skewed alignment of the streets. Crossings that continue the alignment of the skewed streets are easier to navigate and provide the shortest, most direct pedestrian path of travel; however, the crosswalk itself is longer than a right-angle crossing would be. Crosswalks that are perpendicular to the cross street are shorter; however, imposing right-angle crosswalks on a skewed intersection forces pedestrians

Crosswalk configurations at skewed intersections.

*Left to Right:* right angle crosswalk (shortest crossing distance); aligned crosswalk (shortest pedestrian route); funnel crosswalk (provides both options for pedestrians)





to detour around the intersection, and is less intuitive for wayfinding, creating challenges for those with impaired vision. (see illustration at right). To give pedestrians more options, designers may also consider flaring the crosswalk into a funnel shape so that the inside edge aligns with the sidewalk on both sides of cross street, and the outside edge is at a right angle with the cross street.

Care should be taken not to push the crosswalk so far back that sight lines needed by turning motorists are compromised and the intersection clearance increases, resulting in more vehicles passing through the crosswalk during the pedestrian walk phase. The skew has the advantage of keeping the pedestrians closer to the intersection for turn visibility and keeping the clearance distances to the minimum. The preferred design for stop bars at skewed intersections is to orient them perpendicular to the vehicle lanes and stagger them in a stair step pattern back from the angled crosswalk.

**Curb radii.** Where streets intersect at non-right angles, the two corners with acute angles will have sharper turns than a standard intersection of the same width. In order for larger design vehicles to make the turn, oversize curb radii may be required, which, especially when combined with the crossing distance added by the skew, can result in very wide crossings. To counteract this effect, designers should consider strategies to shorten the crossing and/or visually narrow the intersection, including:

- Use curb extensions at the two opposite (obtuse angle) corners
- Use at-grade surface paving treatment, as described in Section 5.2

**Slip lanes.** Due to turning radius requirements at the acute corners, skewed intersections will often necessitate a slip lane for right turning vehicles, with a corner island to break up the pedestrian crossing. Raised corner islands provide a pedestrian refuge and are preferable to simple painted islands. However, wherever feasible, slip lanes should be removed to connect the island to the sidewalk with a corner plaza and shorten the overall crossing distance (see Section 5.4). Where this is not possible, other design strategies should be considered, such as special paving treatments in the slip lane, raised crosswalks, or auto restrictions (transit and bicycle-only lanes).

**Public space and landscape opportunities.** As described above, unusual intersections often offer the opportunity to use excess right-of-way space to create small corner plazas or landscaped areas, especially by removing a slip lane. See Sections 5.4 and Section 5.8.

**Lighting.** A coherent pattern of intersection lighting at complex intersections can reinforce the legibility of the intersections as a single, unified place and enhance pedestrian orientation. Consistent lighting at each corner should be used to achieve this effect—when a street's overall lighting is being upgraded, lighting designers should identify any non-right angle intersections and pay special attention to these.

**Roundabouts.** Roundabouts have limited applicability in San Francisco, and can create difficult pedestrian and wayfinding conditions. However, they may be an appropriate and desirable treatment at complex, multi-leg intersections to simplify the traffic movements and create central public or green space. See Section 5.7.



Conversion of a corner slip lane into a public space

# Sidewalk Width and Zones

Well-designed sidewalks are a fundamental part of good multi-modal streets. They are the building block of a great pedestrian environment and are critical to the quality of public life and pedestrian safety in San Francisco.

Sidewalks should be included on both sides of all streets throughout the city. As pedestrian crossings at intersections are considered extensions of the sidewalk, crosswalk closures create discontinuous sidewalks and should be evaluated and re-opened as appropriate (see Section 5.1).

Sidewalks should enable active public space and accessible pedestrian travel. Amenities such as landscaping, lighting, seating, and merchandise displays work to activate the street. These amenities should be properly organized to ensure safe and accessible travel. To accomplish this balance, a sidewalk must simultaneously be viewed holistically and through the organizing logic of a set of zones. The five zones, from property line to curb, are:

- **Frontage Zone:** The area adjacent to the property line where transitions between the public sidewalk and the space within buildings occur
- **Throughway Zone:** The portion of the sidewalk for pedestrian travel along the street
- **Furnishing Zone:** The portion of the sidewalk used for street trees, landscaping, transit stops, street lights, and site furnishings
- **Edge Zone:** The area used by people getting in and out of vehicles parked at the curbside
- **Extension Zone:** The area where pedestrian space may be extended into the parking lane, via features such as bulb-outs with mid-block plazas

These terms are used throughout this plan.

## SIDEWALK WIDTH

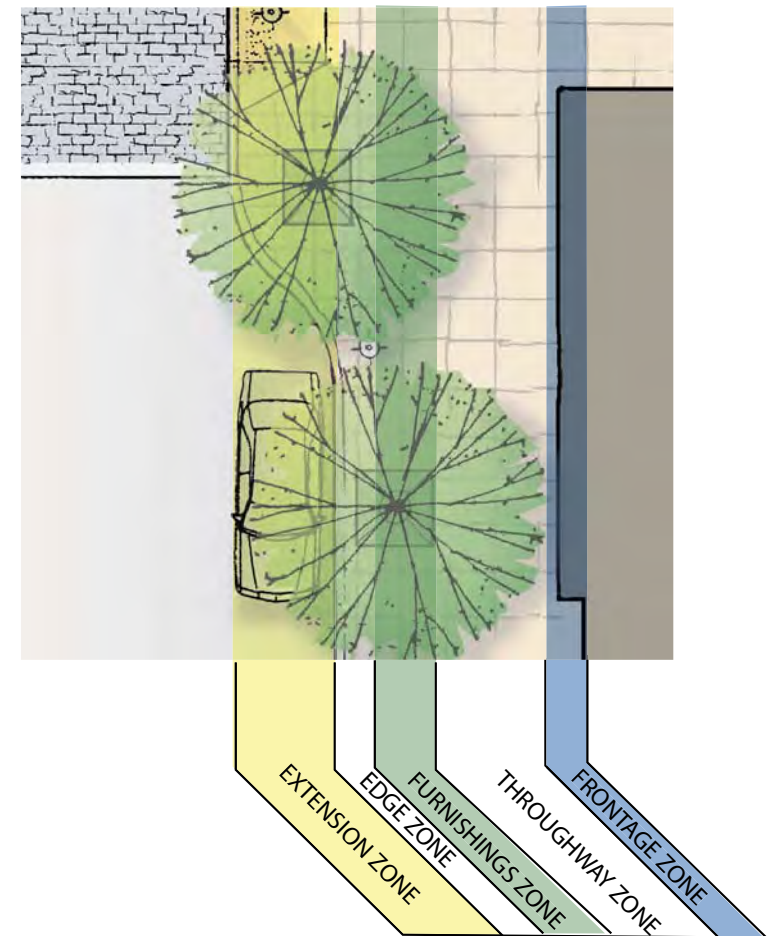
Sidewalk width has significant implications for streetscape design and the quality of the pedestrian environment. Sidewalks that are too narrow prevent pedestrians from moving safely and comfortably. Narrow sidewalks also make it difficult or impossible to provide important additional streetscape elements and pedestrian amenities.

A wide sidewalk offers pedestrians enough space to walk at their chosen pace, stand, sit, socialize, or merely enjoy their surroundings. Wider sidewalks also offer more space for landscaping and amenities, making the streetscape more useful and attractive and also acting as a buffer between traffic and pedestrians.

In addition to street types as described in this plan, the following variables should be considered in determining appropriate sidewalk width:

- **Adjacent land use:** High-intensity uses attract more pedestrians, generally necessitating greater sidewalk widths.
- **Adjacent building form:** Taller buildings create greater shadow and scale; wider sidewalks can create greater separation from the buildings, and allow more sun to reach sidewalks opposite tall buildings.
- **Adjacent ground floor use:** Office and residential uses are often slightly set back to allow a transition from public to private spaces. In contrast, buildings with active ground floor uses typically front more directly onto the street and often spill out into the sidewalk with seating or merchandise displays. These features may constrain clear sidewalk width.
- **Roadway characteristics:** Pedestrians are typically more comfortable on sidewalks that are buffered from moving vehicles. Faster, higher volumes of cars and trucks require a wider buffer to create a comfortable walking environment. On-street parking and bicycle lanes can serve as buffers; where they are not present, additional sidewalk width and landscaping may be necessary.

Sidewalk Zones (Plan View)





## Interactions With Adjacent Parcels

The Better Streets Plan focuses primarily on improvements to the public right-of-way. However, fronting properties also exert a strong influence on the quality and character of the pedestrian realm that go beyond the scope of this plan. Specific ways in which properties can enhance or detract from the public realm include:

- Parking lot edges: opportunities for landscaping and screening of surface lots
- Building setbacks: balancing the desire for a consistent street wall with opportunities for wider sidewalks or fronting plazas
- Ground-floor uses and building design that creates activity at street level
- Overhead projections, such as awnings, marquees, signs, and balconies, that can add character to a streetscape, but may also interfere with tree plantings or accessibility

## Minimum Sidewalk Width

All sidewalks should meet the minimum widths described in Figure 4.3, as measured from the face of the curb. Existing sidewalks may be narrower than the minimum widths for a variety of reasons, from physical constraints to historical context. Sidewalks that are below these widths should be considered deficient; when funding allows or the street is otherwise being reconstructed, they should be considered for widening as feasible given right-of-way constraints.

Where it is not possible to achieve minimum widths within existing rights-of-way, requiring consistent building setbacks may be considered as a way to provide extra space.

**FIGURE 4.3**  
**MINIMUM AND RECOMMENDED SIDEWALK WIDTH BY STREET TYPE**

	STREET TYPE	MINIMUM WIDTH	RECOMMENDED WIDTH
<b>COMMERCIAL</b>	Downtown commercial	Per Downtown Streetscape Plan	
	Commercial throughway	12'	15'
	Neighborhood commercial	12'	15'
<b>RESIDENTIAL</b>	Downtown residential	12'	15'
	Residential throughway	12'	15'
	Neighborhood residential	10'	12'
<b>OTHER</b>	Industrial	8'	10'
	Mixed-use	12'	15'
<b>SPECIAL</b>	Parkway	12'	17'
	Park edge	12'	24'
	Multi-way boulevard	12'	15'
	Ceremonial	varies	varies
	Alley	6'	9'
	Shared public way	NA	NA
	Paseo	varies	varies

## Recommended Sidewalk Width

Sidewalks should strive to meet or exceed the recommended sidewalk widths, as measured from the face of the curb, shown in Figure 4.3. These widths allow for the provision of all desired streetscape elements on the sidewalk. Major new development or redevelopment areas that create new streets must meet or exceed recommended sidewalk widths.

On new streets, where continuous building setbacks are proposed, minimum sidewalk width may be narrowed by the width of the applicable frontage zone, as determined on a case-by-case basis.

Streetscape improvement projects should evaluate opportunities to widen sidewalks to the recommended minimums as conditions allow. However, most street improvements in San Francisco take place within existing constrained rights-of-way (as opposed to entirely new streets), and trade-offs among various travel modes are often necessary.

## Sidewalk and Median Width

Though medians can add aesthetic value and safety benefits, roadway space is often more valuable to pedestrians as part of sidewalks rather than as part of a median, particularly where sidewalks are less than the recommended sidewalk width for the appropriate street type. On the other hand, due to the difficulty and cost of moving curbs, utilities, driveways, site furnishings and plantings (especially if trees are mature), widening sidewalks by a small amount may be a less cost-effective manner of improving a street than adding median space. This determination should be made on a case-by-case basis.

## SIDEWALK ZONES

This section includes dimensions and guidelines for each sidewalk zone. The dimensions for sidewalk zones are meant as a general guide, within overall sidewalk width as described above. Appropriate widths for each sidewalk zone vary based on numerous conditions, such as overall sidewalk width, pedestrian volumes, adjacent land uses, presence of driveways, etc. Dimensions include the width of the curb.

Considerations for width of individual sidewalk zones will differ for constrained sidewalks; that is, sidewalks that are below the recommended widths shown in Figure 4.3. Constrained sidewalks are discussed in the following section.

### Frontage zone

**Use:** Adjacent uses may occupy this zone for outdoor displays, café or restaurant seating, and plantings, with appropriate permits.

Architectural elements that encroach into the street such as awnings, canopies, and marquees may also occupy this zone.

On sidewalks not wide enough to accommodate a large furnishing zone, elements that would normally be sited there such as benches, newsracks, trash cans and poles may occupy the frontage zone to keep the through-way zone clear.

**Width:** On all street types, the frontage zone should be 18 inches to provide a comfortable shy distance for pedestrians or to allow adjacent uses to utilize the space.

On commercial street types, the frontage zone should be a minimum of 2 feet in width to allow for café tables and seating, benches, planting, merchandise displays, and other amenities, and higher volumes of window shopping and entering and exiting of doors. In many cases, the frontage zone should be wider to create a generous seating area.

Where there is relatively little pedestrian traffic, or where there are continuous building setbacks, the Frontage Zone may be decreased, or eliminated altogether, as determined on a case-by-case basis.

### Throughway Zone

**Use:** The throughway zone is intended for accessible pedestrian travel only and should be clear of obstacles, including driveway aprons or other changes to cross-slope. The walking surface may be constructed of any walkable, accessible material.

In limited circumstances on narrow sidewalks, ADA-compliant tree grates may be counted toward the minimum clear path of travel; however, as they are difficult to maintain to an accessible standard, this is not a preferred solution.

Overhanging elements such as awnings, store signage, and bay windows may occupy this zone as long as there is a clear distance under them of at least 80 inches, as required by accessibility standards.

**Width:** Accessibility regulations require a clear path of travel of minimum 4 feet in width, widening to a minimum of 5 feet at least every 200 feet.

Alleys should maintain a minimum 4 feet clear path of travel; all other street types should maintain a minimum 6 feet of clear. In very limited circumstances (such as neighborhood residential streets with very low pedestrian volumes), this may be reduced to 4 feet minimum. Where adjacent frontage or furnishing zones are kept clear of obstacles and are paved with an accessible surface, this width may be included in the minimum required clear width.

For streets with higher pedestrian volumes, such as commercial and downtown streets, additional width should be provided to accommodate large numbers of pedestrians.

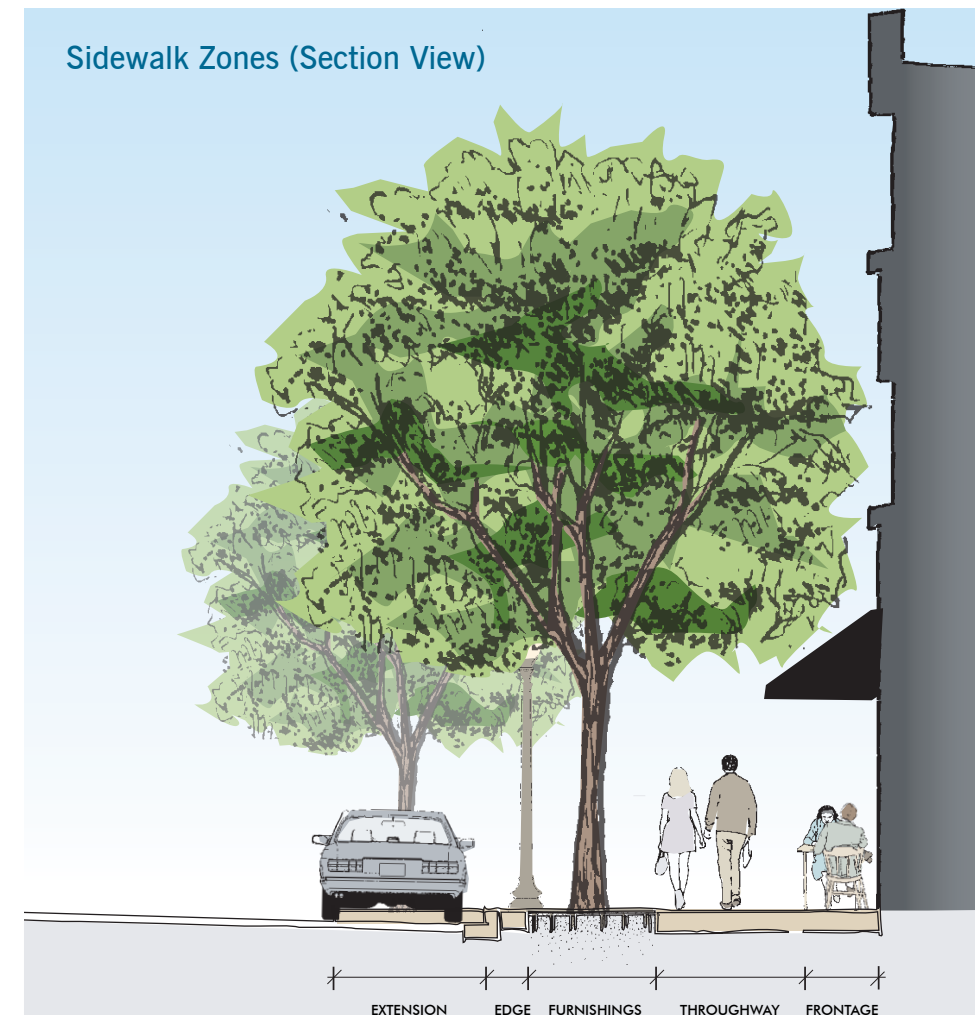
### Furnishing zone

**Use:** The furnishing zone acts as a buffer between the active pedestrian walking area (throughway zone) and street traffic. Street trees and other landscaping, streetlights, site furnishings, traffic and parking poles and equipment, utility poles and boxes, fire hydrants, and other site furnishings should be consolidated in this zone. See Chapter 6 for specific guidelines for each of these elements.

The furnishing zone may be differentiated from the throughway zone through paving scoring, materials, or edge treatments to indicate that the furnishing zone is a place for lingering as opposed to moving.

**Width:** Where street trees or sidewalk landscaping is provided, the furnishing zone should be a minimum of 3 feet in width. (See Section 6.1)

### Sidewalk Zones (Section View)





As the furnishing zone acts as a buffer between pedestrians and the roadway, the width of the furnishing zone should be based upon traffic speeds and volumes and whether on-street parking is provided. If no on-street parking is provided and traffic speeds are 25 mph or less, the furnishing zone dimension should be a minimum of 4 feet in width. For speeds of 30 mph or above, the furnishing zone should be one foot wider for every 5 mph increment in posted speed above 30 mph.

In many circumstances, the furnishing zone may be considerably wider than this, to incorporate significant planting, seating, or stormwater facilities, and give the sense of the furnishing zone as a public space.

Where there is a continuous landscape treatment, a minimum 3 foot walkable path should be provided from the edge zone to the throughway zone every 20 feet, aligned with the mid-point of the parking space. See also the City's Sidewalk Landscape Permit guidelines.

### Edge zone

**Use:** The edge zone is the interface between the roadway and the sidewalk, and is intended for use by people accessing parked cars. To allow people to get into and out of parked vehicles, the edge zone should have a walkable surface.

The edge zone may have some vertical elements, such as street lights, utility poles, parking meters, or traffic and parking signs, as long as these elements are non-continuous and allow space between for car doors to swing open and for people to access parked vehicles.

Street tree basins may also intrude into the edge zone, with the same requirements. Continuous sidewalk plantings are not generally allowed in the edge zone; however, where there is no adjacent parking lane, the edge zone may contain continuous sidewalk plantings or site furnishings.

See also the City's Sidewalk Landscape Permit guidelines.

**Width:** On streets with no parking lane, the edge zone may be omitted.

On streets with parallel parking, where there is a continuous planting strip or other continuous raised element (such as a raised planter, or stormwater planter with lip), the Edge Zone must be a minimum of 2 feet wide to allow access to parked vehicles.

Regularly-spaced non-continuous elements, such as parking meters, poles and street trees and basins, may encroach to within 18 inches of the face of the curb so long as elements allow space for open car doors and for people to get in and out of cars.

On streets with angled or perpendicular parking, the edge zone must be a minimum of 30 inches.

All dimensions are given from face of curb.

### Extension zone

**Use:** The extension zone refers to specific conditions where the sidewalk extends into the parking lane. Specific examples include curb extensions, flexible use of parking lanes, and bicycle parking, tree planting, and stormwater features in the parking lane.

The extension zone may house elements such as landscaping, seating, stormwater facilities, and other site furnishings. Elements such as newsracks, traffic and parking signs, and kiosks may be consolidated in the extension zone (on curb extensions) to free up sidewalk space for through travel.

**Width:** Where the pedestrian realm is expanded into the extension zone, it should take up the full width of the curb extension or parking lane. Curb extensions should follow the guidance in Section 5.3. Parking lane treatments should follow the guidance in Section 5.6.

FIGURE 4.4  
SUMMARY OF SIDEWALK ZONE GUIDELINES

ZONE	EXTENSION	EDGE	FURNISHINGS	THROUGHWAY	FRONTAGE
<b>Width</b>	<ul style="list-style-type: none"> <li>Width of parking lane</li> </ul>	<ul style="list-style-type: none"> <li>0' (where no parking lane, or no continuous planting)</li> <li>2' (where parking lane and continuous planting)</li> <li>2'6" (where angled or perpendicular parking)</li> </ul>	<ul style="list-style-type: none"> <li>3' (where trees or landscaping are provided)</li> <li>4' (+ 1' for every 5 mph increment over 25 mph)</li> <li>Wider (as needed for site furnishings/public space)</li> </ul>	<ul style="list-style-type: none"> <li>4' minimum per ADA and on alleys; widening to 5' every 200'.</li> <li>6' on other street types</li> <li>Wider (to accommodate expected pedestrian volumes)</li> </ul>	<ul style="list-style-type: none"> <li>18"</li> <li>2'+ (commercial and mixed-use streets)</li> <li>Less (where continuous setback is provided)</li> </ul>
<b>Use</b>	<ul style="list-style-type: none"> <li>All site furnishings, trees and landscaping, street lighting, and utilities</li> <li>Flexible use of parking lane</li> </ul>	<ul style="list-style-type: none"> <li>Walkable surface</li> <li>Non-continuous vertical elements such as street lights, utility poles, parking meters, etc. with 18" clearance to curb</li> <li>Street trees and basins, with non-continuous planting</li> </ul>	<ul style="list-style-type: none"> <li>All site furnishings, trees and landscaping</li> </ul>	<ul style="list-style-type: none"> <li>Clear of obstacles; accessible walking surface</li> <li>Overhanging elements (&gt;80")</li> <li>Tree grates (not preferred)</li> </ul>	<ul style="list-style-type: none"> <li>Displays, cafe seating</li> <li>Furnishings aligned with frontage</li> <li>Planters (surface or above-ground)</li> <li>Overhanging elements</li> </ul>

## CONSTRAINED SIDEWALKS

This section describes how sidewalk zones should be divided in situations where the sidewalk width is constrained; that is, where sidewalks are below the recommended overall width shown in Figure 4.3. On constrained sidewalks, individual sidewalk zones must be correspondingly smaller as well, necessitating trade-offs. Some sidewalk zone dimensions are fixed as discussed in the previous section (such as minimum required through width for accessibility, or edge zone width where there is a continuous sidewalk planter), while others are variable depending on conditions.

Where a constrained sidewalk width does not allow for the recommended dimensions for each zone, the design of the street should meet the following criteria (in order of priority):

- Accommodate required access for people with disabilities and access to adjacent uses and transit stops.
- Accommodate expected levels of pedestrian activity.
- Provide necessary buffering between the active area of the sidewalk and adjacent traffic.

- Integrate design elements to enhance the public realm, and provide space for adjacent businesses to use the sidewalk for seating and displays.

In many cases, individual sidewalk zones should be greater than the minimum depending upon the context. For example:

- On streets with significant pedestrian volumes, the throughway zone should be proportionally wider.
- Where there is significant high-speed vehicle traffic and a need for buffering pedestrians, or a desire to create a public space character or significant planting area, the furnishing zone should be proportionally wider.
- On commercial streets with larger numbers of restaurants where there is a desire to encourage outdoor seating, the frontage zone should be proportionally wider.

Sidewalk dimensions are given from face of curb.

### 6 Foot Sidewalk (Alleys)

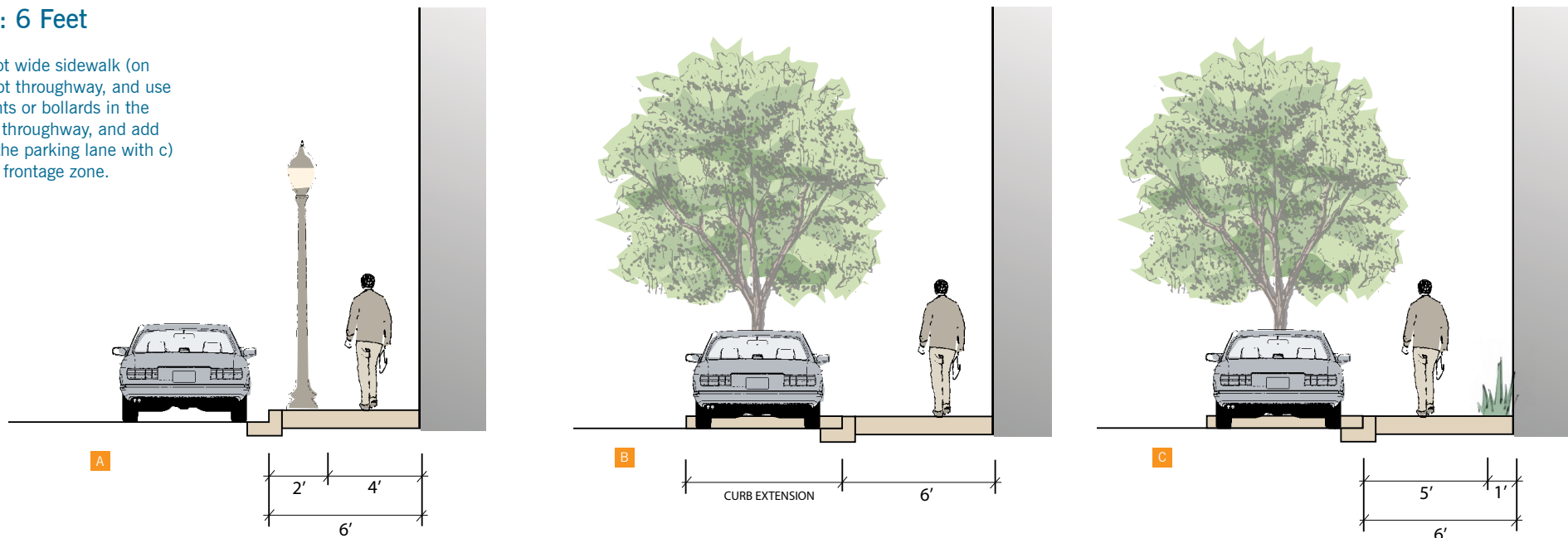
Six foot sidewalks (typically found on alleys) do not have enough room for a furnishing zone with tree plantings. Alternatively, the frontage zone may have a building-adjacent planter, leaving 4 to 5 feet for through travel. Curb extensions may allow for additional plantings, trees, or site furnishings. Converting the alley to a shared public way is preferable, to allow more comfortable pedestrian space.

### 7 to 8 Foot Sidewalk

On 7 to 8 foot sidewalks, a 3 foot furnishing zone with street trees would leave 4 to 5 feet of through width. This width is sufficient on alleys and on some neighborhood residential streets with low pedestrian volumes; however, on most streets, a 6 foot throughway zone should be provided, meaning there is not enough space for a row of street trees. The designer should consider narrower design elements in the edge zone, such as street lights or bollards. Curb extensions may allow for additional plantings, trees, or site furnishings.

### Constrained Sidewalks: 6 Feet

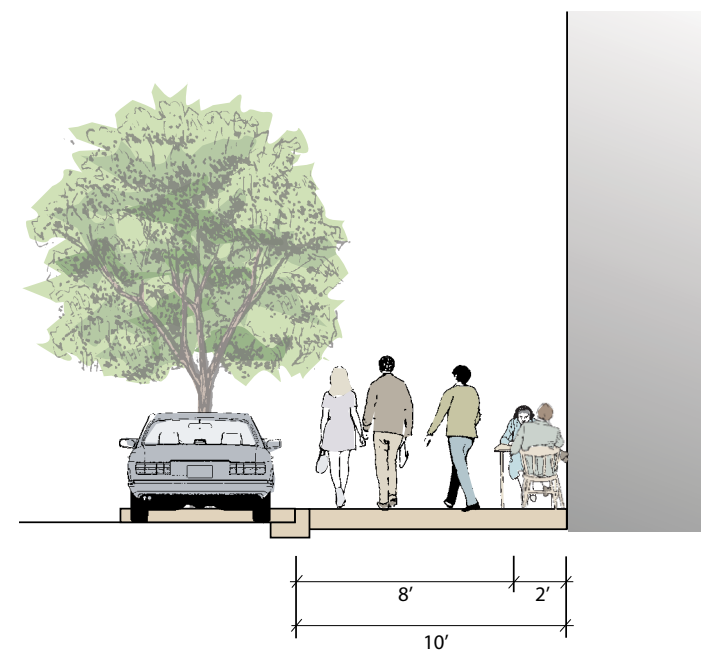
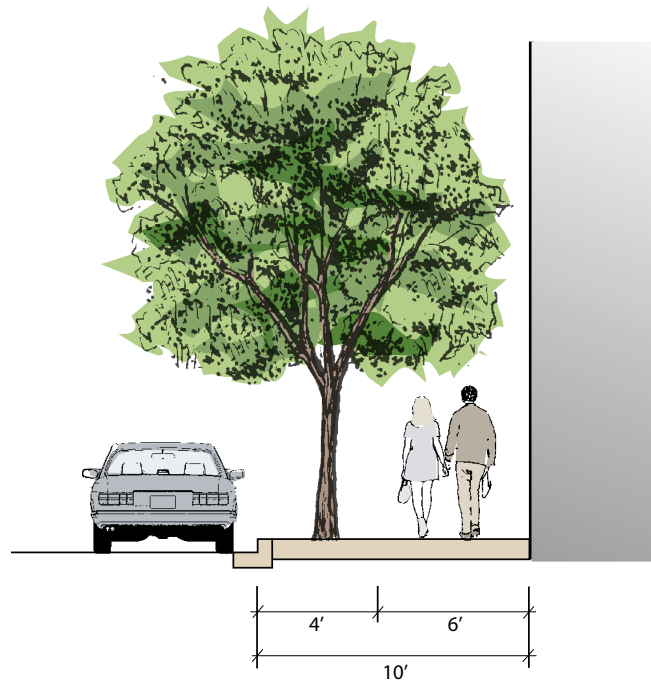
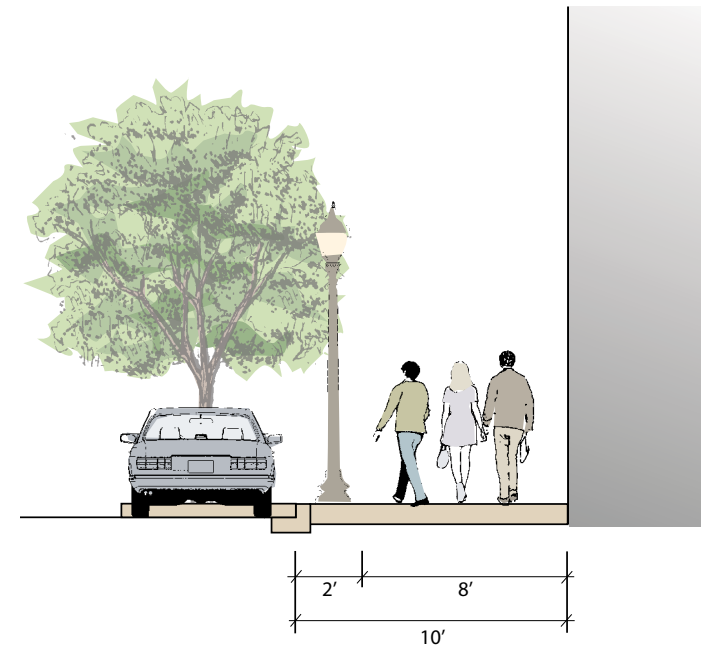
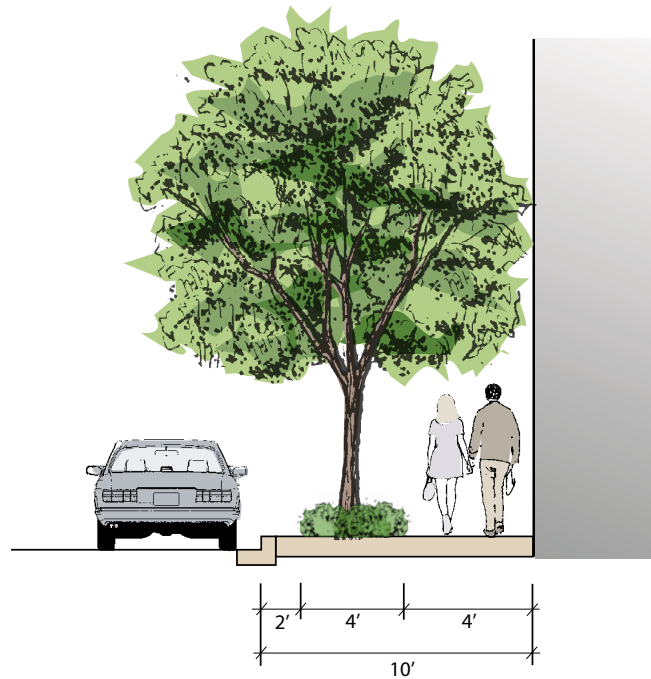
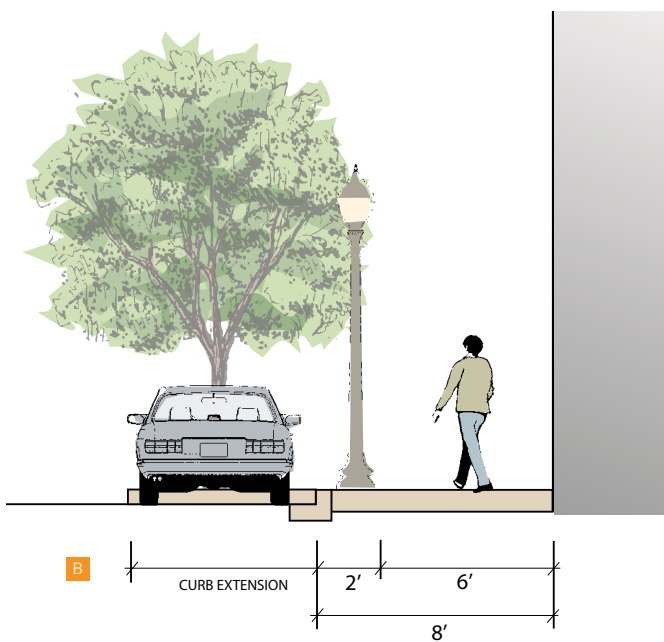
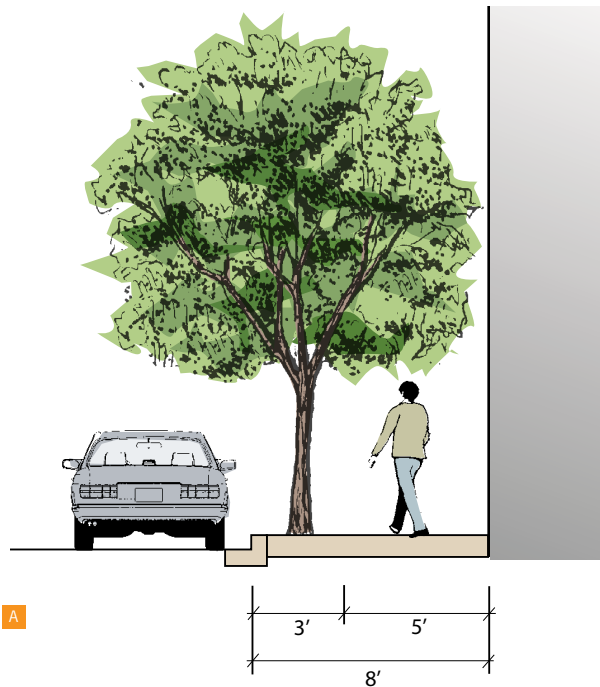
Three options for designing a 6 foot wide sidewalk (on alleys): a) Retain a minimum 4 foot throughway, and use narrow elements such as streetlights or bollards in the edge zone; b) Retain a 5 to 6 foot throughway, and add street trees on curb extensions in the parking lane with c) optional 1 foot wide planter in the frontage zone.





**Constrained Sidewalks: 7 To 8 Feet**

Two options for dividing an 8 foot wide sidewalk: a) On alleys or some neighborhood residential streets, retain a minimum 4 foot throughway, and plant trees in the furnishings zone (min. 3 feet); b) On other street types, retain a 6 foot throughway, use narrow elements such as streetlights or bollards in the Edge Zone, and add optional curb extensions with street trees.



**Constrained Sidewalks: 9 To 10 Feet**

See text for description

### 9 to 10 Foot Sidewalk

A 9 or 10 foot sidewalk allows a few options for dividing the sidewalk space:

- On alleys or some neighborhood residential streets, use a 4 to 5 foot through-way zone, 3 to 4 foot furnishing zone with street trees and landscaping, and 2 foot edge zone. The presence of the edge zone allows for a planting strip;
- Where a 6 foot clear path is required, the sidewalk could be divided into a 6 foot through-way zone and a 3 to 4 foot furnishing zone, with street trees but no planting strip; or

- On downtown or commercial streets with congested sidewalks (such as on Stockton Street), there should be a 6 foot or greater through-way zone, with either or both a 2 foot frontage zone (for merchandise displays or outdoor seating) or edge zone (with narrow design elements such as street lights or bollards).

### 11 to 12 Foot Sidewalk

11 to 12 foot sidewalks meet the minimum overall sidewalk widths described in Figure 4.3. However, they still may not be wide enough to achieve all the desirable amenities that create a quality streetscape. Eleven to twelve foot sidewalks may be divided in numerous ways, including:

- On residential streets, an optional 2 foot frontage zone (with plantings), a 4 to 6 foot through-way zone, a 4 foot furnishing zone with optional planting strip, and 2 foot edge zone;
- On commercial, downtown, or mixed-use streets, a 2 foot frontage zone (for displays or seating), a 6 foot through-way zone, and a 4 foot furnishing zone; or
- On downtown or commercial streets with congested sidewalks, an 8 foot or greater through-way zone, with a 2 foot frontage zone (for merchandise displays or outdoor seating) and/or edge zone (with narrow design elements such as street lights or bollards).

### Constrained Sidewalks: 11 To 12 Feet

See text for description

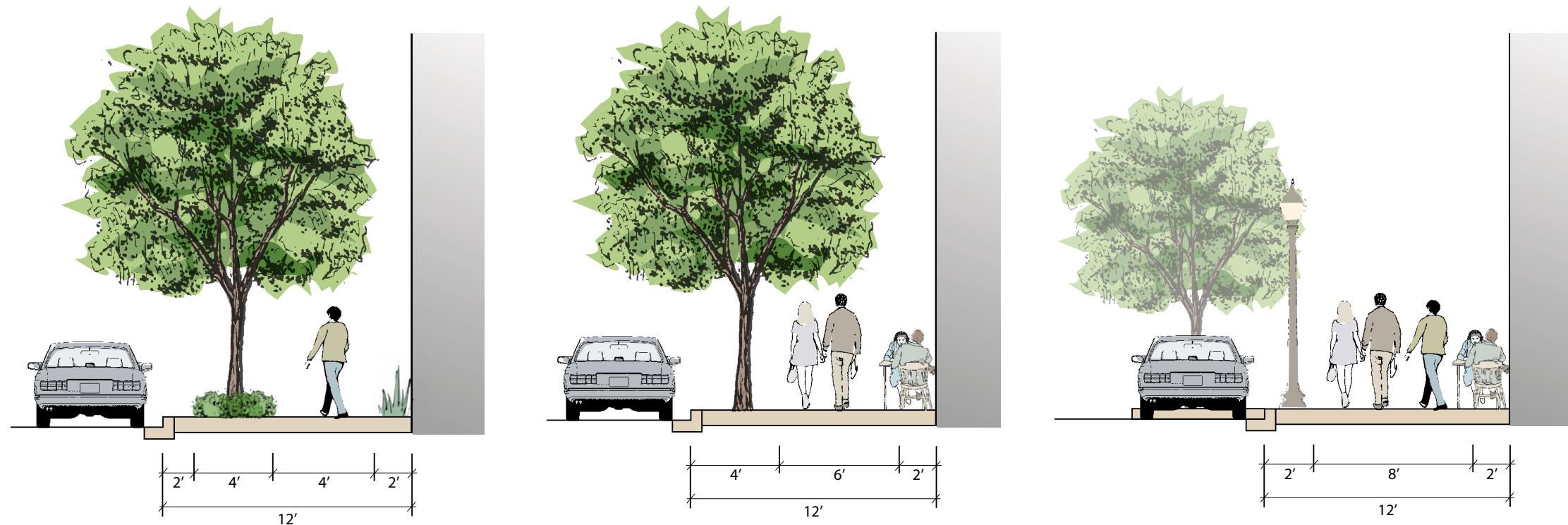
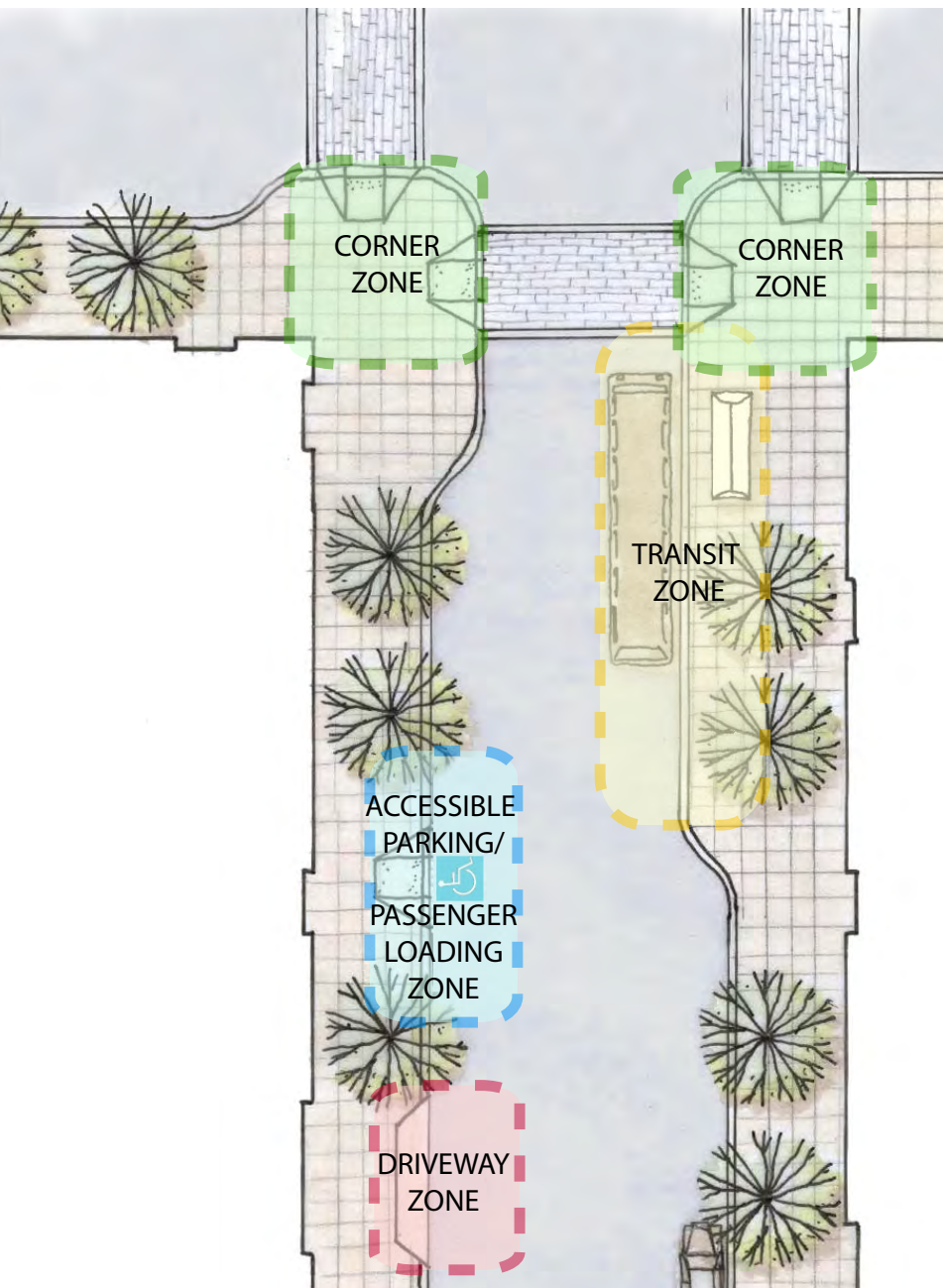




FIGURE 4.5  
SPECIAL SIDEWALK ZONES



## SPECIAL SIDEWALK ZONES

Certain portions of the streetscape require special consideration in terms of the spacing and placement of streetscape elements. The following guidelines offer specific guidelines for these areas.

### Corners

Corners (as defined by an extension of the property line to the curb) should be kept clear of obstructions. They should maintain drivers' and pedestrians' clear views of each other. Amenities should be clustered adjacent to corners but not within the corner zone itself.

The following streetscape elements are appropriate for corners:

- Corners should include curb ramps and detectable warning surfaces per accessibility regulations.
- Pre-existing utility poles and sub-surface vaults may be prohibitively expensive to move, and may remain in place. However, they should be relocated as funding and opportunities allow.
- On residential streets, corners may include a corner planter to the width of the furnishing zone on the adjacent sidewalks, so long as sufficient clear width for curb ramps is maintained.

### Transit Stops

Transit stops require special layout guidelines due to the high number of people often waiting near them and the need to board and alight from transit vehicles. Transit stops require special layout guidelines to accommodate passengers who are waiting, boarding or alighting, and the need for vehicles to deploy lifts. See Section 5.5.

### Accessible Parking and Passenger Loading Zones

Accessible parking and passenger loading zones require special streetscape considerations to ensure that passengers may safely get into and out of vehicles. Specific guidelines include:

- Street trees, furnishings and other obstructions should allow a minimum of 8 feet of clear sidewalk width adjacent to the curb.
- Special paving treatments and sub-surface utilities may be located within this zone, as long as they provide an accessible surface.

### Driveways

Driveways present special challenges to the pedestrian due to changes in cross-slope and the presence of vehicles crossing the sidewalk. See Section 6.6.

### Medians

Medians can add substantial greenery to the streetscape, decrease impermeable surface, offer opportunities for pedestrian refuges, and offer locations for lighting and some utilities.

Wide medians on some streets offer opportunities for lines of trees that are otherwise difficult to achieve along sidewalks.

Sufficiently wide medians (12 feet or more) generally can be designed to include seating and gathering areas and other pedestrian amenities.

Medians also create opportunities for pedestrian refuges at busy intersections. See Section 5.4.

### Ground-Level Planting (6.1)

Ground-level planting, including in-ground (understory planting) and containerized (above-ground planting), complements street trees and adds vibrancy and diversity to the street.

**Spacing:** Ground-level planting should be consistent in spacing, scale, and shape along a block or corridor and on both sides of the street.

**Location:** Ground-level planting should be located in the furnishings and frontage zone. Planters should come as near to corners, driveways, and other streetscape elements as possible per Section 6.1. Understory planting may be located in tree basins or in landscaped planting strips.

**Special Considerations:** A 4 foot walkable path should be provided for at the center of each parking space to provide access to parked vehicles between planting areas. Sub-surface utility vaults, poles, and streetlights may be located within the surface planter beds if they are concrete-set.

### Street Lighting (6.3)

Street lighting works in conjunction with street trees to establish the rhythm of the streetscape. On streets where it is not feasible to plant trees, street lighting may be the primary organizing element.

**Spacing:** Street light spacing should be consistent along the length of a block or corridor. Exact spacing may vary based on the height of light fixtures and desired light levels. Lighting on medians should complement the scale, character, and rhythm of lighting on the sidewalk.

**Location:** In general, lighting should be located in the edge zone. Pedestrian-scaled lighting may also be appropriate in the frontage zone. Lighting should be offset from street trees in a regular pattern, either mid-way between trees or at a consistent distance on either side.

**Special Considerations:** Where separate poles for roadway and pedestrian lights exist, each should be spaced in an even pattern; however, this pattern may need to be adjusted to achieve specific desired light levels.

### Site Furnishings (6.5)

Site furnishings such as benches, information kiosks, and trash cans add greatly to the character, comfort and functionality of a streetscape. Consideration should be given to proper placement and design.

**Spacing:** Site furnishings should be placed in predictable locations, particularly near transit stops, at corner locations on short blocks, and at mid-block locations on longer blocks. Site furnishings should be evenly spaced along the street; where possible, they may be integrated with other streetscape elements. For example, benches or bike racks can double as tree guards, reducing the number of furnishings and potential for clutter.

**Location:** Site furnishings should be aligned in the center of the Furnishing Zone. Some furnishings such as bicycle racks and benches should be perpendicular to the roadway where sidewalk width allows, in order to efficiently use sidewalk space. Site furnishings should be located at the ends of on-street parking stalls rather than at the center where possible to make it easier for passengers to get in and out of parked cars. Site furnishings should leave sufficient clear width when fully loaded, opened, or occupied.



◀ Sidewalk planters can help define a streetscape character and a rhythm of streetscape elements

FIGURE 4.6

### APPROPRIATE STREETSCAPE ELEMENTS BY SIDEWALK ZONE

SIDEWALK ZONE	APPROPRIATE ELEMENTS (GENERAL)
FRONTAGE	Merchandise displays, cafe seating, furnishings aligned with building frontage, planting along building frontage
THROUGHWAY	Special paving, sub-surface utilities.
FURNISHINGS	Trees and plantings, seating, bicycle racks, kiosks, cafe seating, public art, utility boxes and vaults, other site furnishings
EDGE	Street lights, parking meters, signage poles, bollards, sub-surface utilities, non-continuous tree basins.
EXTENSION	Planting and seating areas in flexible parking zones or on curb extensions, trees in islands

Elements listed here should also meet appropriate clearances and guidelines per Chapter 6.



# Streetscape Layout

This section provides a general overview of the placement and layout of typical streetscape elements. When carefully placed, these elements contribute to the creation of an attractive and comfortable pedestrian realm.

## GENERAL LAYOUT GUIDELINES

The following guidelines should govern the placement of all streetscape elements:

- **Wisely allocate limited space:** Given limited street space, streetscape elements may conflict with one another, limit visibility, block pedestrian travel, or create a sense of clutter. All streetscape elements should be located with consideration for the requirements and constraints of other streetscape elements that may be placed on the street. For example, tree locations should consider the scheme for street lighting and vice versa.
- **Strive for “wholeness”:** Layout of streetscape elements should emphasize “wholeness,” or placement that looks at an entire block or corridor rather than individual placement of elements in a piecemeal fashion. The layout should consider the overall city pattern, provide a consistent aesthetic treatment, and be consistent with long term goals for the design and function of the street.
- **Accommodate pedestrian needs:** The placement of streetscape elements should allow the comfortable and efficient flow of pedestrians along the street and from parked cars and adjacent buildings to the sidewalk. At the same time, streetscapes should provide a diversity of amenities and spaces for public enjoyment and include elements of surprise and variety that reflect the specifics of unique places.

## LAYOUT GUIDELINES BY ELEMENT

Each streetscape element plays its own role in helping establish a safe and comfortable pedestrian realm. These guidelines provide an overview of layout considerations for standard streetscape elements. Detailed guidelines for each of these elements can be found in Chapter 6.

### Street Trees (See Section 6.1)

Street trees should be the primary organizing elements of the streetscape

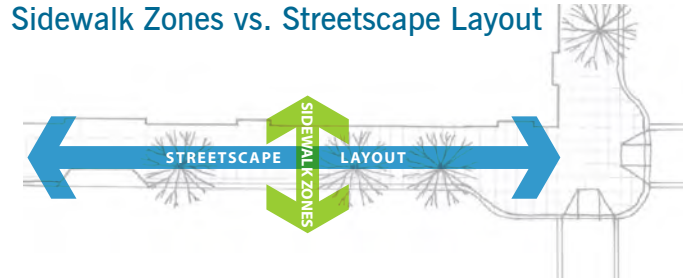
**Spacing:** Street trees should be placed in a continuous line with consistent spacing to establish a visual rhythm for the street. Other streetscape elements should be located to minimize conflicts with potential street tree locations. It is preferable to place trees slightly off the exact desired spacing than to leave a gap. Tree planting should extend as close to the intersection as feasible, per Section 6.1. Where sidewalk width allows, double rows of trees may be planted.

▶ *Left:* A well-organized streetscape balances pedestrian through travel and provision of amenities (Broadway)

*Right:* Trees and lighting define the rhythm of the streetscape (Octavia Boulevard)



## Sidewalk Zones vs. Streetscape Layout



**Location:** Generally, street trees should be planted in the furnishing zone. Trees may also be planted in the extension zone where space and visibility allows.

**Special Considerations:** Trees planted in a median should complement the scale, character, and rhythm of trees in the sidewalk. Trees in medians provide an opportunity to create a consistent rhythm, as their placement is less likely to vary due to driveways, utilities, and other sidewalk constraints. Alternatively, wide medians provide an opportunity for creative planting designs that create a unique aesthetic to complement the more regular pattern on the sidewalk.

## New Streets in Major Development Areas

Because San Francisco is a mostly built-out city, most applications of the Better Streets Plan will occur on existing city streets. However, in some locations, new streets will be created as part of major new development areas. Streets built as part of these projects should be consistent with the Better Streets Plan guidelines; in addition, these areas warrant special considerations and present opportunities to design new complete streets from the ground up, with fewer constraints than on existing city streets.

General guidelines for new streets include:

- New streets should connect to and extend San Francisco's existing street grid wherever possible. Street designs should read as extensions of public streets, not as privatized portions of master developments.
- New streets should create a complete multi-modal system that prioritizes walking, bicycling and transit use over private automobile use, connecting to and complementing the City's larger pedestrian, bicycle, and transit networks. Streets should be designed for speeds appropriate to the street type and surrounding land uses.
- Within the new street network, roadway width should be minimized while retaining necessary transportation access. Many pedestrian safety countermeasures such as pedestrian refuges, traffic calming measures, and signage and related engineering measures may not be necessary if the overall width profile of the street is minimized from the outset.
- Where a new street network is being created, streets should be designed with an overall concept for on-street parking, taking into account adjacent land uses and off-street parking provided as part of new development. The design of new streets may use strategies such as providing parking pods or bays, or eliminating the parking lane altogether to narrow the overall street width.
- Where new streets are created, streetscape features can be designed in tandem with new utilities and infrastructure, rather than adjusted to fit around existing utilities. Sidewalk widths, stormwater facilities, and utilities should be designed and laid out to optimize design goals toward a consistent overall aesthetic and functional whole.
- New development fronting on new streets should minimize curb cuts, using alleys where possible for service and access functions.
- New streets present the opportunity to create meaningful and unique places or designs; new streets may consider unique arrangements that create superior design.

Specific guidelines for new streets include:

- New streets should follow all Better Streets Plan guidelines regarding street designs and sidewalk elements (Chapters 4, 5 and 6).
- New streets should include, at a minimum, the standard improvements for each street type. Case-by-case additions may be considered as well.
- Sidewalks on new streets must meet or exceed recommended sidewalk widths. Where consistent building setbacks are provided, the sidewalk width may be reduced by the width of the frontage zone, as determined on a case-by-case basis.

### Curb extensions

Curb extensions should be provided at all corners per Section 5.3. Alternatively, on narrow, low-volume, and low-speed streets, designers may consider eliminating the parking lane or using parking bays to create a narrower overall street profile.

### Medians

Where provided, medians should include street trees and understory plantings. See Section 5.4.

### Pedestrian-Priority Designs

New alleys should be designed as shared public ways. See Section 5.8.

### Transit-Priority Designs

Transit stops should be designed to Better Streets plan guidelines. See Section 5.5.

### Streetscape Elements

Major new development or redevelopment areas should create a streetscape master plan to guide the selection of streetscape elements, including trees and plantings, lighting, paving materials, and site furnishings; the design of such elements should be internally consistent, and harmonious with the character of surrounding areas. Streetscape elements should come from a City-approved palette, where applicable.

### Urban Forest

Street trees should be planted on all sidewalk lengths, per the guidelines in Section 6.1. Understory plantings should be included as well on appropriate street types.



Source: 2010 Hunters Point Shipyard Design for Development

### Stormwater

New development in combined sewer areas must comply with the requirements of the San Francisco Stormwater Design Guidelines. See Stormwater Design Guidelines, and Section 6.2 of this plan.

In new development areas, there is an opportunity to create the drainage profile of the street from scratch; the best solution may not always be the standard crowned street. For example, single-surface alleys could be designed to drain to the center of the street, or the gutter may be placed between the parking and travel lanes. Non-standard drainage profiles should be considered on a case-by-case basis, based on functional performance measures. The City is currently developing more specific guidelines for drainage on new streets.

### Lighting

New streets should meet the recommended targets for pedestrian lighting, per Section 6.3. Pedestrian lighting may be supplemented with roadway lighting as necessary to light the street to required levels.

### Utilities and driveways

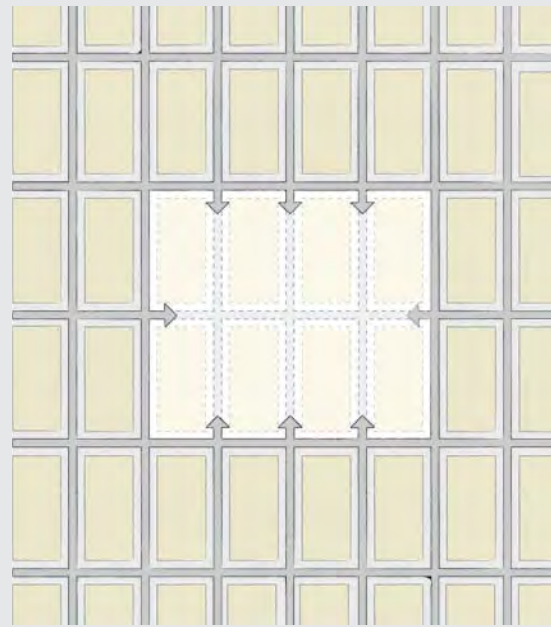
New streets provide an opportunity to locate utilities so that they do not interfere with pedestrian circulation and sidewalk activity. Utilities associated with new buildings should be located on private parcels (away from public-facing ground-floor facades) wherever possible.

If utilities must be in the right-of-way, they should be located in the roadway as feasible, in the edge zone, or otherwise located to minimize disruption to the overall streetscape. See Section 6.6.

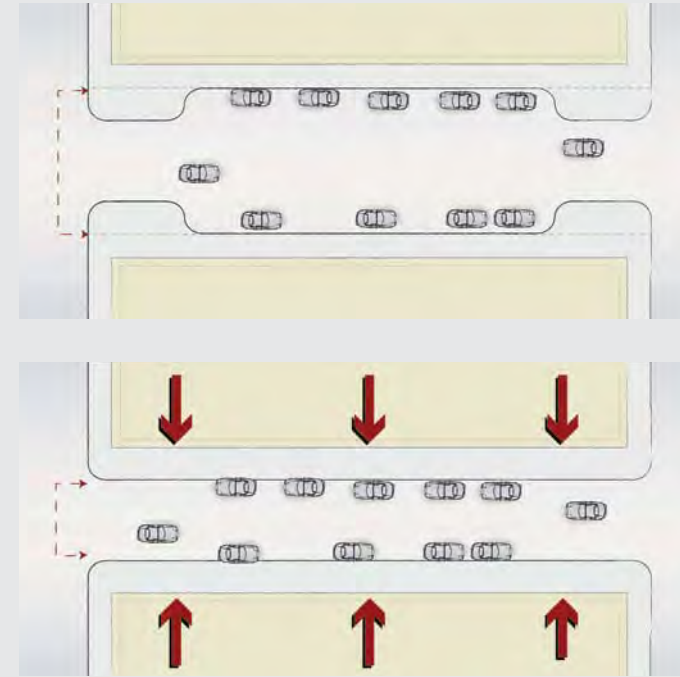
Driveway cuts should be minimized to minimize disruption to the streetscape, maintain a consistent street edge, and reduce conflicts with pedestrians and bicylists. Alleys should be used wherever feasible for garage access. See Section 6.6.



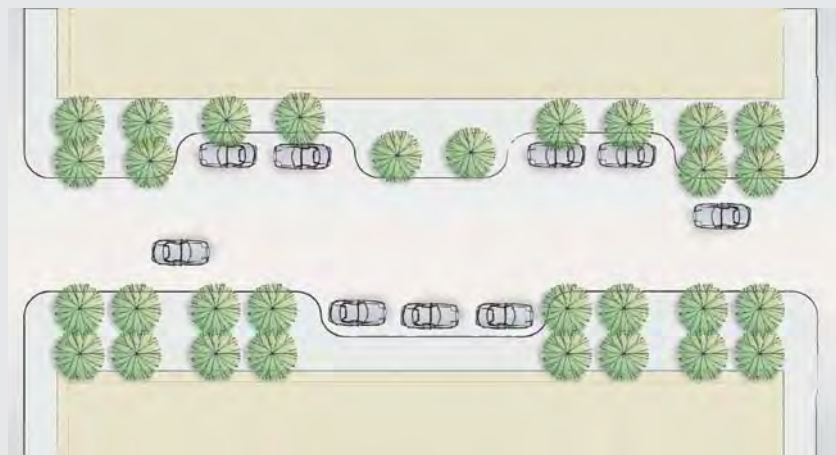
New streets should extend the existing City grid



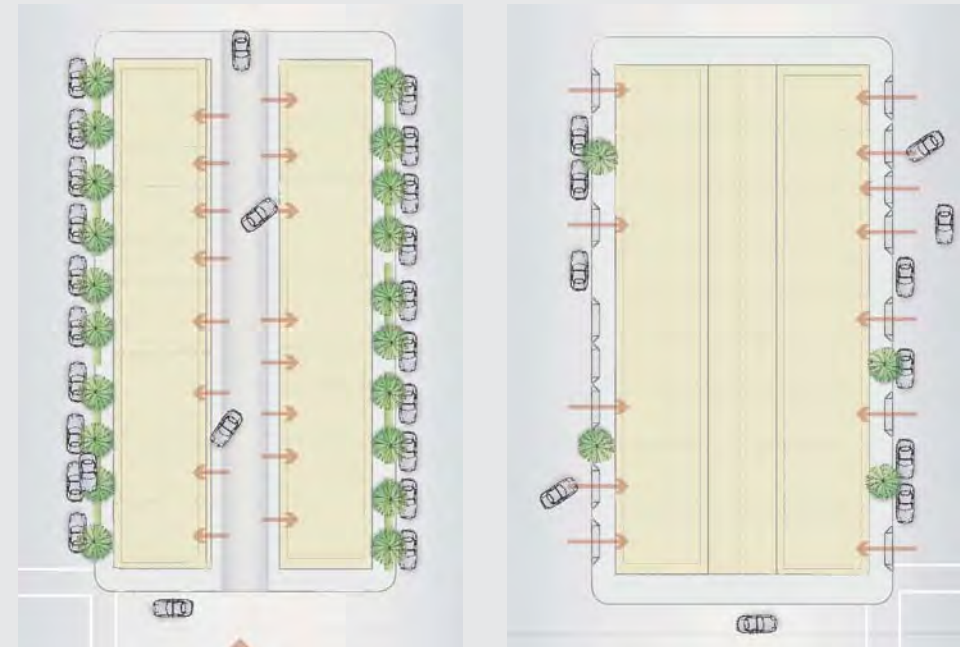
New streets should minimize overall width



New streets should integrate on-street parking into the overall street design



New streets should incorporate alleys for driveway access





# CHAPTER

# 300



CHAPTER


# 5.0

## STREET DESIGNS

- 5.1 Crosswalks and Pedestrian Signals
- 5.2 Corner Curb Radii
- 5.3 Curb Extensions (Bulb-Outs)
- 5.4 Medians and Islands
- 5.5 Transit-Supportive Streetscape Design
- 5.6 Parking Lane Treatments
- 5.7 Traffic Calming and Roundabouts
- 5.8 Pedestrian-Priority Designs

# GUIDE: STREET DESIGNS

The location and shape of curb lines exerts a strong influence on pedestrian comfort and usability of streets as public spaces. This chapter describes pedestrian-oriented guidelines for curb lines, crosswalks and other street design features to enhance pedestrian safety and comfort and enable generous, usable public spaces



Marked crosswalks are an essential part of the pedestrian realm that enable safe, convenient pedestrian travel across roadways.



# Crosswalks and Pedestrian Signals

## 5.1

### CROSSWALK MARKINGS

Marked crosswalks are an essential tool for helping pedestrians move safely, conveniently and predictably across roadways. When treated with decorative paving material, crosswalks also provide a unique streetscape design treatment to emphasize pedestrians' presence and primacy.

Marked crosswalks alert drivers to expect crossing pedestrians and to direct pedestrians to desirable crossing locations – marking crosswalks at every intersection is not necessary or desirable. Although many motorists are unaware of their precise legal obligations at crosswalks, the California Vehicle Code requires drivers to yield to pedestrians in any crosswalk, whether marked or unmarked.

Streetscape design should emphasize crosswalks as a fundamental part of the pedestrian realm, not as an intrusion into the roadway reserved for vehicles only.

### Placement

Crosswalks are present by law at all approximately right angle intersections, whether marked or unmarked, unless the pedestrian crossing is specifically prohibited. At mid-block locations, crosswalks only exist where marked. At these non-intersection locations, it is the crosswalk markings that legally establish the crosswalk. Most importantly, the decision to mark a crosswalk should not be considered





in isolation, but rather in conjunction with other measures to increase motorists' awareness of pedestrians. Without additional measures, marked crosswalks alone are unlikely to increase pedestrian safety and may decrease safety, particularly on multi-lane streets. Follow SFMTA crosswalk guidelines in determining when to stripe new crosswalks.

**Controlled Intersections**

Intersections can be controlled by traffic signals or STOP signs. Per existing City policy, marked crosswalks should be provided on all intersection legs controlled by traffic signals, unless the pedestrian crossing is specifically prohibited. Crosswalks may be considered at all STOP-controlled intersections. SFMTA has developed detailed guidelines on when to stripe crosswalks at controlled intersections. Factors to be considered include: high pedestrian volumes, vehicle volumes, school zone location, substantial volume of elderly or disabled use, or other safety reasons.

**Uncontrolled Intersections**

Intersections without traffic signals or STOP signs are considered uncontrolled intersections. The decision to mark a crosswalk at an uncontrolled location should be guided by an engineering study. Factors considered in the study include vehicular volumes and speeds, roadway width and configuration, stopping sight distance, distance to the next controlled crossing, night time visibility, grade, and pedestrian volumes.

See the SFMTA crosswalk guidelines for direction on when to stripe crosswalks at uncontrolled intersections.

**High-Visibility Crosswalks**

Because of the low approach angle at which pavement markings are viewed by drivers, the use of longitudinal stripes in addition to or in place of the standard transverse markings can significantly increase the visibility of a crosswalk to oncoming traffic. While research has not shown a direct link between increased crosswalk visibility and increased pedestrian safety, high-visibility crosswalks have been shown to increase motorist yielding and channelization of pedestrians, leading the Federal Highway Administration (FHWA) to conclude that high-visibility pedestrian crosswalks have a positive effect on pedestrian and driver behavior.

San Francisco has chosen to utilize continental crosswalks for high-visibility crosswalk locations. Maintenance and installation of high-visibility 'continental' crosswalks costs more than standard crosswalks. Despite their added cost and the lack of hard evidence pointing to their safety benefits, many cities see continental crosswalks as a cost-effective way to improve the walking environment and to send a message that pedestrians are present. For this reason they are often employed even at controlled locations that are neither near schools nor at mid-block locations yet still deserve extra attention.

In San Francisco, continental crosswalks have typically been employed only at school crossings and mid-block locations. The SFMTA plans to expand the use of continental crosswalks to some uncontrolled intersections.

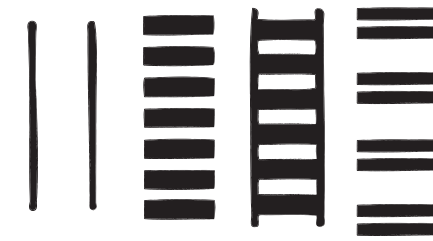
**Mid-Block Crosswalks**

In areas with short block lengths, closely-spaced intersections ensure that pedestrians can easily find crosswalks without having to go out of their way, but many areas have long blocks with widely-spaced intersections and fewer crossing opportunities. Mid-block crosswalks may provide a convenient crossing for pedestrians when other crossing opportunities are distant, or where a destination creates high crossing demand.

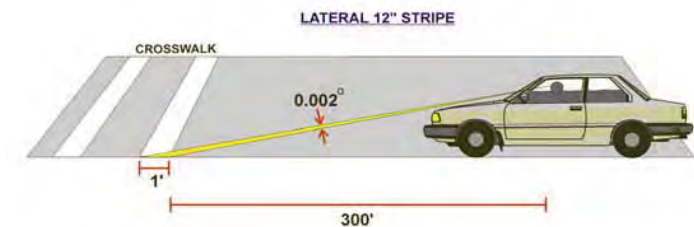
See the SFMTA crosswalk guidelines for direction on when to stripe mid-block crosswalks. Site-specific analysis and environmental clearance would be required for any proposed mid-block crossing to identify whether it would result in or contribute to unacceptable levels of service or delay to transit vehicles.

**Design**

Crosswalks should be at least as wide as the sidewalk, but may be wider in locations with high pedestrian demand or narrow sidewalks. Crosswalks should be no less than 10 feet in width. Crosswalks must be outfitted with curb ramps and tactile warning strips per federal accessibility guidelines. The California Manual on Uniform Traffic Control Devices (MUTCD) contains standards and guidance on crosswalk warning signs and supplementary markings.



▲ Typical crosswalk markings. Left to right: Standard, Continental, Ladder, Staggered Continental



▲ Driver's view of crosswalk markings. Source: ITE Professional Development Complete Streets





### Standard Crosswalks

The standard treatment for marked crosswalks at intersection locations consists of two 12 inch-wide white retro-reflective thermoplastic stripes that delineate the sides of the pedestrian walking area. The stripes should be perpendicular (or transverse) to the direction of vehicle travel and parallel to the direction of pedestrian travel. School crosswalks must be yellow per state code; in San Francisco, school crossings should be given a yellow, continental crosswalk treatment.

### High-Visibility Crosswalks

High-visibility crosswalks should be marked using the continental pattern of crosswalk striping, which consists of a series of wide stripes parallel to the curb for the length of the crossing. (These are distinguished from ladder crosswalks, which retain the transverse side stripes of the standard crosswalk in addition to the wide ‘rungs’ of the ladder, or zebra crosswalks, which have diagonal stripes. See diagram on previous page.)

- ▼ The staggered continental crosswalk increases crosswalk visibility but positions stripes to avoid vehicle wheels, reducing maintenance burdens

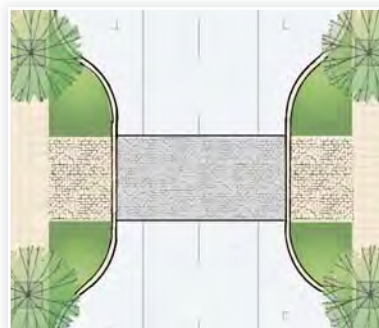


In order to provide high-visibility crosswalks while minimizing increases to maintenance costs, the SFMTA plans to implement a pilot installation of a “staggered” continental crosswalk, with the longitudinal stripes positioned to avoid vehicle wheel paths as much as possible, reducing wear. This strategy has been employed successfully in Washington, Oregon, and Colorado for many years.

### Mid-Block Crosswalks

Mid-block crossings should:

- be enhanced through the use of signage, striping, signalization, or other special treatments such as flashing beacons, special paving materials, or raised crossings;
- be constructed in combination with mid-block curb extensions (see Curb Extensions, Section 5.3); and
- include pedestrian lighting oriented toward the crossing.



Mid-block crossings improve pedestrian convenience, especially on long blocks.



## SUPPLEMENTARY PEDESTRIAN CROSSING TREATMENTS

### Pedestrian Warning Signs

Pedestrian warning signs are used to alert road users to the potential presence of pedestrians. Their use should follow MUTCD guidance and be limited to locations where pedestrians may make unexpected entries into the roadway or where drivers’ sight distance is restricted. In San Francisco, placement of pedestrian warning signs has historically not followed this guidance, leading to an over-proliferation of the signs and a consequent dilution of their effectiveness. The City should review the placement of its existing pedestrian warning signs and remove them at unwarranted locations, potentially increasing their impact where they are most needed.

### Advance Stop and Yield Lines

Stop lines (or limit lines) are solid white lines 12 to 24 inches wide, extending across all approach lanes to indicate where vehicles must stop in compliance with a stop sign or signal. Advance stop lines reduce vehicle encroachment into the crosswalk and improve drivers’ view of pedestrians.

On multilane roads, advance stop & yield lines can be an effective tool for preventing multiple threat vehicle and pedestrian collisions. SFMTA has developed guidelines for the installation of advanced stop lines consistent with the national guidance found in section 3B.16 of the MUTCD, which allows for their use from 4 to 50 feet in advance of crosswalks, depending upon location-specific variables such as vehicle speeds, traffic control, street width, on-street parking, potential for visual confusion, nearby land uses with vulnerable populations, and demand for queuing space.

Yield lines are another option that can be used to reduce the possibility of multiple threat collisions at uncontrolled crosswalks on multi-lane roadways. They consist of a single row of white triangles placed across each approach to indicate the point at which vehicles must yield, and may be placed a minimum of 4 feet in advance of uncontrolled marked crosswalk locations.



### Flashing Lights and Beacons

**In-roadway flashing lights** are intended to call extra attention to pedestrians in crosswalks where signage or other design treatments are deemed insufficient. The flashers can be activated passively with infra-red or microwave detectors, or actively by pedestrian push-buttons. In San Francisco and elsewhere, in-roadway flashing lights have not performed well due to ongoing maintenance issues. In San Francisco, little or no effect on injury collisions has been discernible (for lack of collisions), but measurable increases in motorists yielding to pedestrians have been found.

Section 4L.02 of the MUTCD provides a list of factors to consider (including vehicle and pedestrian volume thresholds) when evaluating the need for in-pavement warning lights at crosswalks, as well as standards for their installation and operation.

If reliability can be improved, in-pavement flashing crosswalks should be considered at high-conflict uncontrolled crossing locations with posted speeds under 35 mph and significant pedestrian volumes that require extra visibility.

**Flashing beacons** can be used to control traffic at intersections where traffic or physical conditions do not justify a full signal but crash rates indicate the possibility of a special need, or to provide supplementary warning of a midblock or uncontrolled school crosswalk. They should be considered for use at high-conflict uncontrolled crossing locations with significant pedestrian volumes where visibility is compromised by grades, curves, or other conditions.

Chapter 4K of the MUTCD provides guidance for the use of flashing beacons.

### Parking Restrictions at Crosswalks

Red parking zones on approaches to crosswalks improve sight distance between pedestrians and approaching motorists and are recommended in the MUTCD for both controlled and uncontrolled intersections. In San Francisco, a minimum 10 foot red zone should be painted on all crosswalk approach legs. Longer red zones should be used at locations with a greater need for improved visibility due to unique sight distance, geometric, or other conditions.

In San Francisco, due to limited on-street parking supply and high demand, the practice has been to allow parking up to intersections unless there are location-specific grounds for parking removal. The new 10 foot minimum guideline will be implemented on a case-by-case basis as resources allow. Priority should be given to intersections with safety issues, existing project locations, and locations where staff is conducting safety reviews. SFMTA's Crosswalk guidelines should be consulted for further guidance regarding red zones.

### Special Intersection Paving

Special intersection paving treatments can break the visual monotony of asphalt streets, highlight crossings as an extension of the pedestrian realm, and announce key civic or commercial locations. Special intersection paving treatments include integrated colors, textures, and scoring patterns. They may be instituted within crosswalk markings or across an entire intersection.

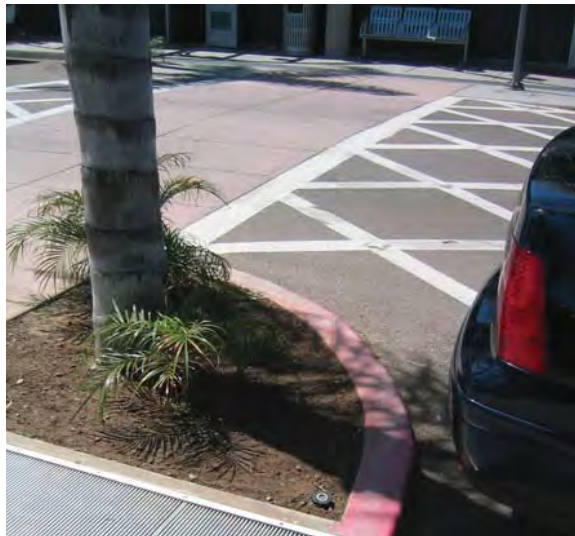


▲ Advance yield lines (top) alert drivers to an impending crosswalk; advance stop lines (bottom) require vehicles to stop in advance of a crossing



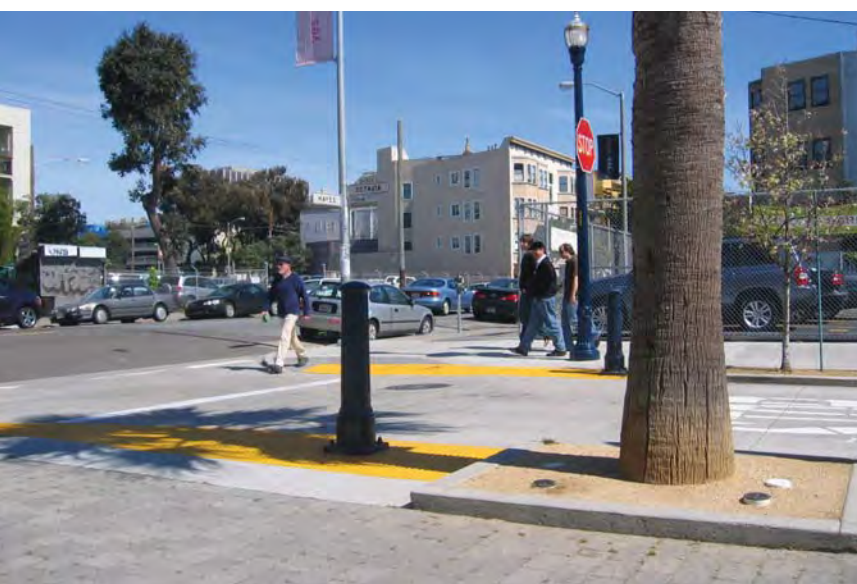
◀ Pedestrian warning sign





▲ Special crosswalk treatments may include a raised crosswalk, colored paving treatment, and trees in the parking lane

▼ Raised crossing at Octavia and Hayes Streets



Special decorative paving, including colored and/or textured concrete, asphalt or pavers, or any similar treatment does not define a crosswalk and should not be seen as a safety measure. Standard transverse or longitudinal high visibility crosswalk markings are still required.

Special intersection paving treatments are more costly to build and maintain than standard treatments. Where capital and maintenance budgets allow, they may be considered on:

- streets important to the city pattern;
- commercial streets;
- at entries to residential areas where residential streets intersect with higher volume streets;
- at key civic locations, such as civic buildings or entries to open spaces; and
- at mid-block crosswalks.

Paving treatments should:

- use integrated color, texture, and pattern. Potential materials include but are not limited to colored and stamped asphalt, poured concrete, and stone or concrete pavers;
- provide a surface that does not cause discomfort due to excessive vibration to those using wheelchairs or other assistive mobility devices;
- use stable, durable, and slip resistant materials per DPW Director's Order 176,112;
- include edging treatments to visually contrast with the primary material and with the asphalt roadway; and
- include crosswalk striping (parallel white lines) on the outer edge of the crossing.

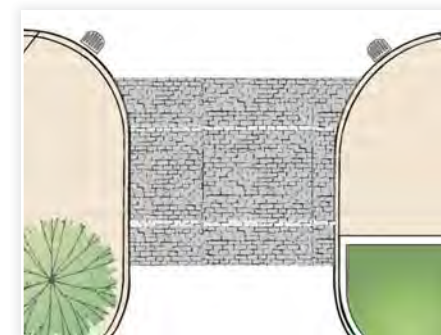
See also Section 6.4: Paving.

### Raised Crosswalks and Intersections

Raised crosswalks bring the level of the roadway to that of the sidewalk, forcing vehicles to slow before passing over the crosswalk and providing a level pedestrian path of travel from curb to curb. Raised crosswalks can be located at intersections or mid block. At intersection locations, the raised area can be extended to include the entire intersection.

Raised crosswalks should be considered:

- as a standard treatment at alleys and shared public ways;
- where low-volume streets intersect with high-volume streets, such as at alley entrances, neighborhood residential streets, and local access lanes of multi-way boulevards;
- where a street changes its function or street type. For example, a commercial thoroughway may become a neighborhood commercial or a residential street as the land uses along it change; and
- at key civic locations.



▲ Raised crosswalks make pedestrian crossing easier and safer for pedestrians by more overtly continuing the sidewalk across an intersection, not only making crossings more visible to drivers, but physically requiring them to slow.

Raised crosswalks should not be used on designated transit routes or where there are steep grades or sharp curves.

Raised crosswalks should:

- be flush with the sidewalk in height, and at least the width of the crossing or intersection;
- be long enough in the direction of travel to allow both front and rear wheels of a passenger vehicle to be on top of the table at the same time - typically 10 feet. Specific lengths should be determined by using the ITE/FHWA document Traffic Calming: State of the Practice;
- be instituted in combination with special paving treatments as discussed above, or use the same material as that of adjacent sidewalks;
- provide detectable warnings where pedestrians will cross into the vehicle area;
- be designed such that the vertical transition does not cause unnecessary jarring or discomfort to vehicle passengers with spinal cord injuries when driven over at the appropriate speed; and
- consider resulting drainage patterns—depending on grade, this may necessitate additional catch basins, trench drains, or other measures;

### Pedestrian refuge islands

Crosswalks may also include pedestrian refuge islands to break up the crossing and slow cars. See Section 5.4: Medians and Islands.

▶ In-roadway flashing lights enhance crosswalk visibility

## PEDESTRIAN SIGNALS

Pedestrian signal indications should be used at all traffic signals. The international pedestrian symbol signal should be used rather than WALK/DON'T WALK text.

### Pedestrian Signal Timing

Pedestrian signals should allow sufficient time for pedestrians to cross the street, including seniors, children, and people with disabilities.

Historically, a standard walking speed of 4.0 feet per second has been used to calculate the minimum pedestrian clearance interval (the flashing red hand plus yellow and any all-red) for pedestrian signals in San Francisco. In anticipation of upcoming changes to federal standards, the City has reduced the walking speed used to time the pedestrian clearance interval to 3.5 feet per second. In nearly all locations in the City, signals allow pedestrians walking as slow as 2.5 feet per second to cross the entire street if they step off the curb at the beginning of the walk phase.

Walking speed is a function of the age and physical ability of the population. The walking speed used to calculate the

pedestrian clearance interval should closely match that of pedestrians in San Francisco, including seniors, children, and people with disabilities. San Francisco is also experimenting with video detection systems to give slower pedestrians additional crossing time. As a next step, San Francisco should conduct studies to determine if slower walking speeds are appropriate and, if so, what those speeds should be.

**Pedestrian ‘scrambles’:** Exclusive pedestrian phases (i.e. pedestrian ‘scrambles’) may be used where turning vehicles conflict with very high pedestrian volumes and pedestrian crossing distances are short.

**Pedestrian ‘head-start signals’:** Leading pedestrian intervals, which give pedestrians a head start before vehicles are given the green, may be considered at signalized intersections with a high incidence of pedestrian conflicts and right-of-way violations.

**Pedestrian-actuated signals:** In San Francisco, signals on short, fixed time cycles should generally be used rather than actuated signals (pedestrian push-buttons) to allow consistent crossing opportunities. Pedestrian actuation should only be used when pedestrian crossings are intermittent, at

▼ Flashing beacon (at left)





locations with relatively long pedestrian clearance time that can result in excessive delay to transit vehicles, and to activate audible pedestrian signals or to provide an extended WALK interval. Since many pedestrians fail to notice pushbutton devices, additional research on passive video and infra-red detection should be conducted.

Timed progression of traffic signals should ensure that sufficient time is allocated per cycle for pedestrian crossings.

### Pedestrian countdown signals

Pedestrian countdown signals are designed to enhance the effectiveness of pedestrian signals at clearing the crosswalk before a signal changes direction. Surveys show that most people misinterpret the meaning of the flashing hand of the traditional pedestrian signal. Providing the pedestrian countdown device helps pedestrians better interpret the pedestrian signals. Countdowns also enable pedestrians to stop on a median refuge, where provided, and wait for the next phase if they find the time left to be too short to finish crossing. Pedestrian countdown signals have been shown to have a 25% reduction in pedestrian injury collisions.

Pedestrian countdown signals should be provided at all signalized intersections.

### Accessible pedestrian signals

Accessible pedestrian signals (APS) provide information in non-visual format such as audible tones, verbal messages, and/or vibrating surfaces. The MUTCD addresses specific pushbutton design and placement for APS and contains standards on audible tones, verbal messages and vibrotactile devices. San Francisco's observations have shown that APS benefits all pedestrians by providing audible and vibro-tactile cues.

APS should be provided at all new signalized intersections. Existing signals should be retrofitted over time, using the SFMTA's APS Prioritization Tool, developed using the draft version of the National Cooperative Highway Research Program (NCHRP) APS Prioritization Tool, in consultation with the Mayor's Office on Disability and individuals and advocacy groups representing the visually impaired community.

## VEHICLE TURNING MOVEMENTS AT CROSSWALKS

### Right Turn on Red

The California Vehicle Code allows drivers to turn right on red after coming to a complete stop, unless prohibited by a sign. Right turn on red (RTOR) prohibitions can be an important tool for increasing pedestrian safety at certain intersections. Under some circumstances, prohibiting RTOR can reduce conflicts and collisions, and it deters motorists from blocking the perpendicular crosswalk while they inch forward to turn. On the other hand, prohibiting RTOR may mean increased vehicle delay, including delay to transit. RTOR prohibition can also lead to more conflicts during right turns on green, since turning motorists must now wait to turn while pedestrians are crossing with the green light.

The MUTCD and the Institute of Transportation Engineers suggest considering the prohibition of RTOR under the following circumstances:

- inadequate sight distance to vehicles approaching from the left (or right, if applicable);
- geometrics or operational characteristics of the intersection that might result in unexpected conflicts;
- an exclusive pedestrian phase;
- an unacceptable number of pedestrian conflicts with right-turn-on-red maneuvers;



◀ Pedestrian countdown signal and accessible pedestrian signal



◀ Pedestrian scrambles allow a dedicated signal phase for pedestrians to cross in any direction at an intersection

- heavy volume of pedestrian crossings;
- request from pedestrians with disabilities using the intersection;
- school crossings;
- railroad crossings; and
- traffic signals with three or more phases.

Beyond the conditions listed above, the City also considers high speeds on cross streets and a verified collision history caused by RTOR maneuvers. As of 2007, signs were posted on one or more approaches of 14% of all signalized intersections citywide (169 out of 1,166).

San Francisco's practice of considering RTOR prohibition at intersections on a case-by-case basis should be continued, subject to the guidelines listed above. RTOR prohibitions may be considered at intersections that:

- have fewer than 300 cars making the right turn per hour; and
- do not have curb-running transit with near-side transit stops.

At intersections that do not meet all of these criteria, RTOR prohibitions may still be appropriate pursuant to additional study and environmental review.

### Multiple turn lanes

Compared to single turn lanes, multiple turn lanes decrease pedestrian comfort and increase potential conflicts between turning vehicles and pedestrians crossing concurrently with the vehicular turning movement. Safety may be compromised if one turning vehicle obscures the driver's view of pedestrians in the crosswalk from a second, trailing vehicle in an adjacent turn lane. Multiple turn lanes may also compromise bicycle safety.

The presence or absence of multiple turn lanes is not by itself a predictor of an intersection's propensity to generate pedestrian collisions. It is important to consider how removing a multiple turn lane and requiring the same number of vehicles to turn from one lane will affect pedestrian and vehicular safety. However, pedestrian perception of safety and conflict reduction is also an important consideration in intersection design.

Multiple turn lanes should be avoided wherever possible. No new multiple turn lanes with conflicting vehicle/pedestrian movements should be built in San Francisco. Existing multiple turn lanes should be pro-actively eliminated or mitigated.

Feasibility of multiple turn lane removal is contingent upon vehicle level of service, queuing, transit operations, and upstream traffic safety considerations. Even if consideration of these criteria do not point to removal of multiple turn lanes, it may still be advisable to make lane assignment changes if there is a documented history of relevant collisions involving pedestrians, and other attempted mitigations have proven ineffective.

If removal is not possible, the City should consider potential mitigations for multiple turn lane conditions found to be problematic. Strategies to mitigate problematic multiple turn lane conditions include the following:

- separate pedestrian and turning movements;
- leading pedestrian intervals;
- permissive-protected signal phasing (pedestrian crossing phase ends before vehicle phase);
- limited hours of multiple turn lanes;
- parking restrictions; and
- signs and enforcement.

### CROSSWALK CLOSURES

San Francisco has a number of closed crosswalks, creating discontinuous pedestrian paths of travel and making walking inconvenient. A primary motivation for closing crosswalks is to safeguard pedestrians in the face of very high traffic volumes or speeds and auto-oriented design, but many times pedestrians ignore crosswalk closures rather than crossing three times to reach a destination that could be reached by one illegal crossing, creating additional safety issues.

New crosswalk closures should not be instituted.

Existing closed crosswalks should be evaluated for opening. This may necessitate additional safety measures such as pedestrian actuation and signal timing changes. Reopening of crosswalk closures will require site-specific analysis and environmental review. At the time the study is undertaken, the effects of removal of crosswalk closure would be evaluated for its impact on the physical environment.



▲ Intersection leg closed to pedestrian crossing



## CURB RAMPS

Curb ramps provide pedestrian access between the sidewalk and roadway for people using wheelchairs, strollers, walkers, crutches, handcarts, bicycles, and pedestrians who have trouble stepping up and down high curbs.

Curb ramps must be installed at all intersections and mid-block locations where pedestrian crossings exist per ADA guidelines. Curb ramps are required at mid-block locations to access on-street accessible parking spaces, where provided, and at all new passenger loading zones. New curb ramps should be prioritized per the City’s ADA transition plan for sidewalks and curb ramps.

### Guidelines

Curb ramps must comply with DPW standard plans. ADA required slopes and dimensions are detailed in DPW Curb Ramp Standard Plans CR-1 through CR-6 and summarized in the figure below.

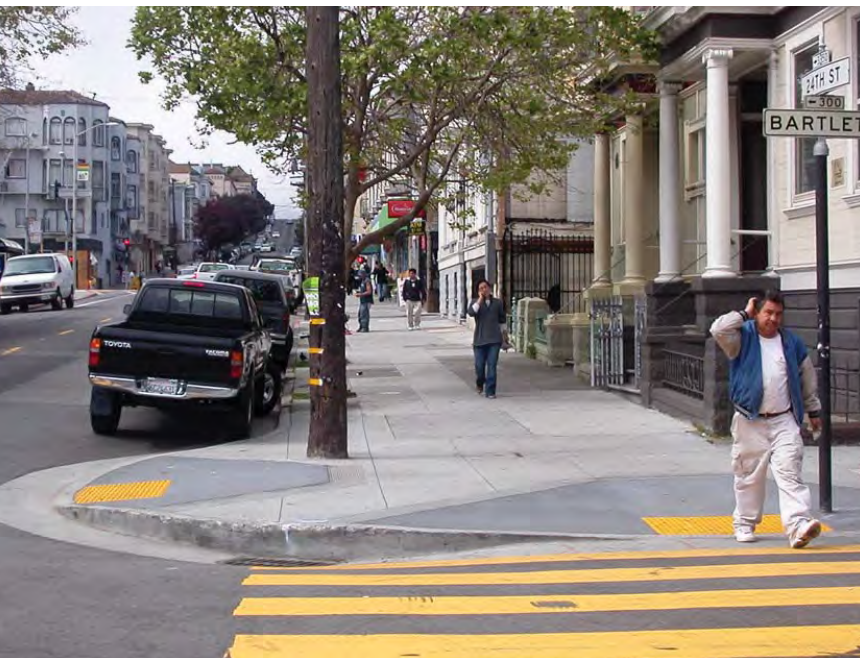
Per standard plans, curb ramps should be installed parallel to the direct path of travel across an intersection. At four-way intersections, two curb ramps should be installed at each corner.

At raised crossings or intersections or other flush transitions between the sidewalk and the roadway, curb ramps are not necessary, but detectable warning strips must be provided. A 3 foot deep detectable warning surface is required where the ramp, landing, or blended transition connects to a crosswalk.

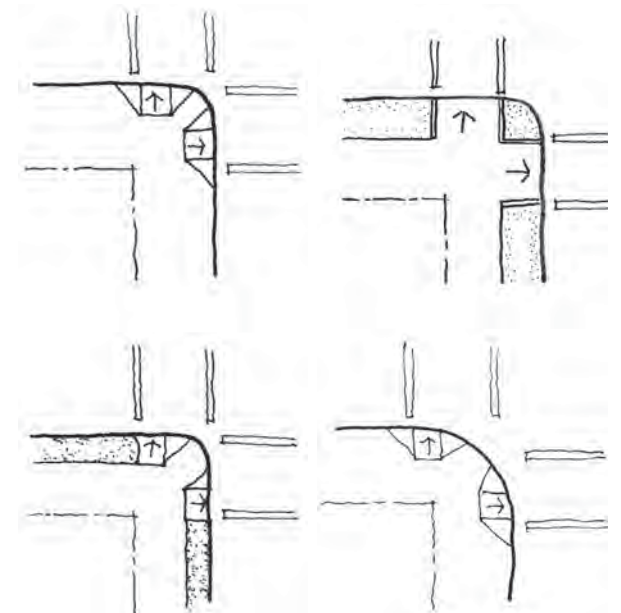
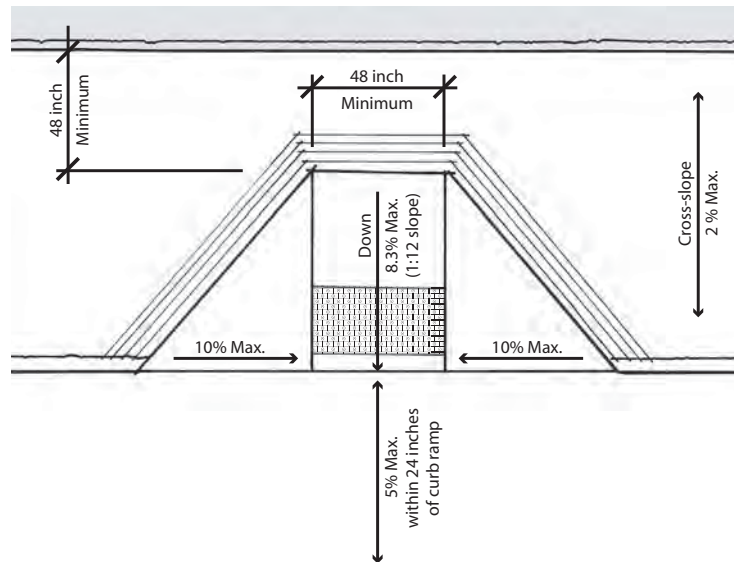
On new streets, storm drainage inlets should be placed on the uphill side of curb ramps to prevent standing water at curb ramp landings.

Small planting areas can be installed at corners on either side of curb ramps as shown in the diagram below.

Curb ramps and crosswalks should remain clear of obstacles. Existing conflicting elements should be moved as opportunities and budgets allow. No new pole, utility or other impediment should be placed in the curb ramp return areas.




▲ Accessible curb ramps



▲ Accessible curb ramps should be provided at all corners, one per crosswalk end





The length of a corner radius can have a significant effect on the overall operation and safety of an intersection.



# Corner Curb Radii

# 5.2

The shape of a corner curb radius (the radius defined by two sidewalks on perpendicular streets that come together at a corner) has a significant effect on the overall operation and safety of an intersection. Smaller turning radii increase pedestrian safety by shortening crossing distances, increasing pedestrian visibility, and decreasing vehicle turning speed.

The shape and dimensions of curb radii vary based on street type and transportation context

## DEFINITIONS

**Design vehicle:** selected vehicle type used in determining appropriate turn radius at an intersection

**Design for [a vehicle turn]:** to allow for a particular vehicle type to complete a turn fully within its designated travel lane or lanes

**Accommodate [a vehicle turn]:** to allow for a particular vehicle type to complete a turn with latitude to use adjacent or opposing lanes on the origin or destination streets

**Curb radius:** the actual radius proscribed by the curb line at an intersection

**Effective radius:** The radius available for the design vehicle to make the vehicle turn, accounting for the presence of parking, bike lanes, medians, or other features



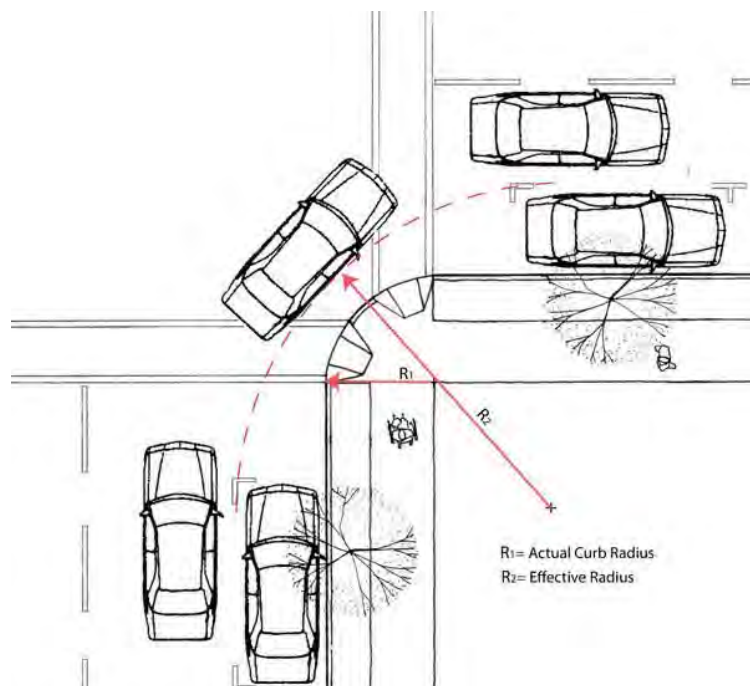
## GUIDELINES

Curb radii should be designed to maximize pedestrian space and shorten pedestrian crossing distance to the greatest extent feasible; the smallest possible curb radius should be used while allowing vehicle movements as described below.

The effective turning radius, not the curb return radius, should always be used to determine the ability of vehicles to negotiate a turn.

These guidelines provide a general overview of the bulb-out design process. However, curb radius design is sensitive to a wide range of variables; these guidelines cannot replace professional judgment and technical analysis. Each project should consider the particular characteristics of the site, and adjust the design as necessary.

- ▼ **EFFECTIVE RADIUS:** Where a curbside parking and/or bicycle lane is present, the effective radius of the turn is increased.



### Design vehicles

Determining a design vehicle should consider and balance the needs of the various users of a street, from pedestrians and bicyclists to emergency vehicles and large trucks, considering the volume and frequency of these various users. The designer should distinguish between “designing for” and “accommodating” the needs of large vehicles (see definitions above).

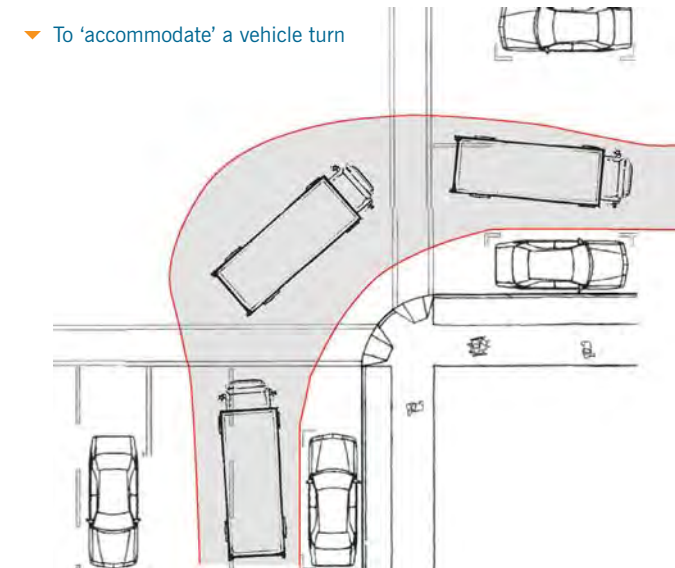
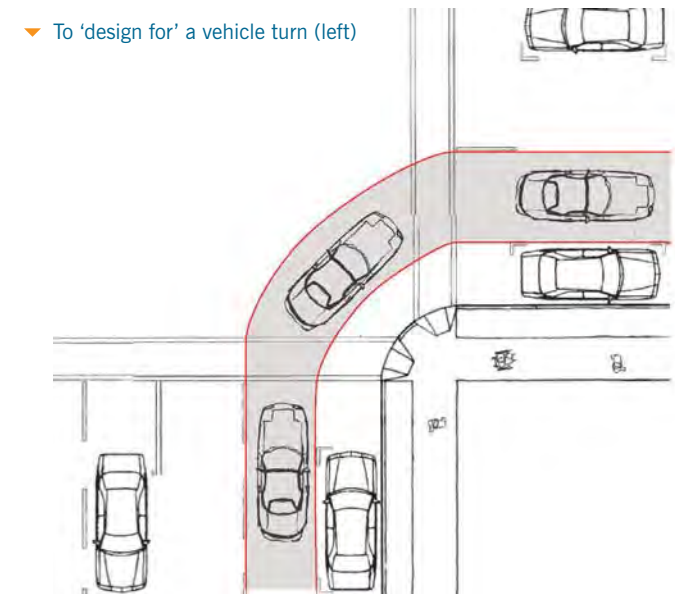
For example, on designated transit or freight routes with frequent large turning vehicles, streets should be “designed for” these vehicles. Where large vehicles are occasional users of a street, there are low traffic volumes, or other characteristics such as high pedestrian volumes necessitate taking greater measures for pedestrian safety and comfort, designers may consider “accommodating” these vehicles.

### General conditions

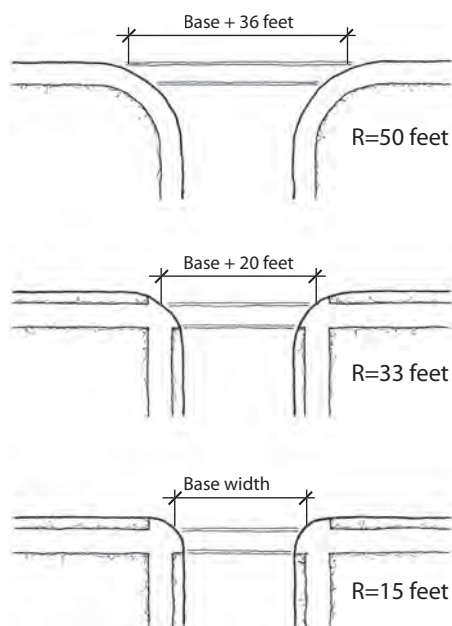
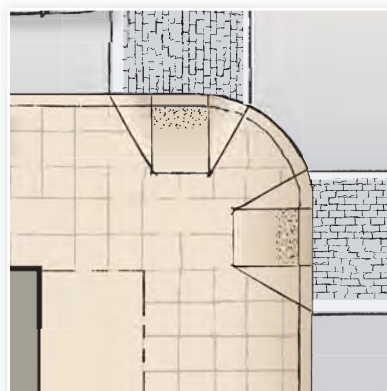
General conditions apply to all streets where conditions are present as described below.

**Emergency vehicles:** All streets greater than 150’ in length should accommodate emergency vehicle (WB-40) turns within the full right-of-way of the intersection. Because emergency vehicles have sirens and flashing lights and other vehicles must pull over, they can typically use the full right-of-way without encountering opposing vehicles. On busier streets, the ability of emergency vehicles to swing wide may be limited by queued traffic which may not be able to pull over.

**Transit routes:** Transit routes include transit service routes as well as routes transit vehicles use to start their run and return to the yard. At intersections where buses make designated turns, streets should be designed for a B-40 bus. On some Muni community routes, Muni may use a B-30 – check with SFMTA. On other corners along Muni routes, where buses may have to make occasional detours, turns should accommodate a Muni vehicle using the entire roadway, similar to an emergency vehicle.







▲ Small curb radii are more pedestrian friendly because they decrease crossing distances and slow vehicles at turns.

Other transit considerations include:

- To determine whether a particular intersection is used by transit vehicles to start their run or return to the yard, check with SFMTA.
- On trolley bus routes, overhead wire locations determine the turning envelope for the bus. No curb radius should be constructed that forces the bus to deviate more than nine feet on center from the middle of the overhead wires. On Muni LRV routes, the curb radius should be constructed such that no part of the sidewalk is closer than two feet from the dynamic envelope of a turning LRV. These routes must also accommodate historic streetcars.
- On streets where other transit providers are present, the curb radius should be designed for their transit vehicles as well.
- Consideration should also be given to private transit operators in areas where large tourist buses and vans are likely to conduct business on a regular, ongoing basis.

**Freight routes:** Freight routes are streets that are designated as “Routes with Significant Truck Traffic” on Map 15 in the Transportation Element of the General Plan. Freight routes should be designed for WB-50 trucks. Larger WB-60 trucks may also be present on City streets, particularly on designated state highways and in industrial areas. These may need to be accommodated in certain instances, though they are not practical in most of San Francisco.

**Standard street types**

Standard street types describe appropriate design vehicles to use per street types, based on Better Streets Plan street types.

**Local streets:** Local streets are typically narrower streets with low traffic volumes and speeds, and limited need for large vehicles.

**Pedestrian-activity streets:** Pedestrian-activity streets typically have high volumes of pedestrians, moderate traffic

CATEGORY	LOCATION	DESIGN VEHICLE	POTENTIALLY ALLOWABLE EXCEPTIONS
TRANSIT ROUTES	corners with turning buses on Muni rapid or local routes or routes rapid or local buses use to start run or return to yard	B-40	P: turn partially from adjacent lane
	corners with turning buses on Muni community routes or routes community buses use to start run or return to yard	B-40; some routes have B-30 buses, check with SFMTA	P: turn partially from adjacent lane
	corners with turning buses on routes served by Golden Gate Transit, AC Transit, SamTrans, Vallejo Transit, University of California transit services, PresidiGo	check with transit provider	P: turn partially from adjacent lane
	corners with potential occasional turning buses due to detours	B-40	P: turn partially from adjacent lane; turn fully from adjacent lane, turn from opposite lane, turn into opposite lane
EMERGENCY VEHICLES	all intersections at streets > 150' in length	WB-40	P: turn partially from adjacent lane, turn fully from adjacent lane, turn from opposite lane, turn into opposite lane
DESIGNATED FREIGHT ROUTES	GP transportation element Map 15 designated “Routes with significant truck traffic”	WB-50	P: turn partially from adjacent lane

P = permitted

volumes, and frequent need for loading access. They function as the central public space of San Francisco neighborhoods.

**Throughways:** Throughways typically have wide roadways, high traffic volumes and speeds, and more large vehicles. They may have significant pedestrian volumes and/or concerns about pedestrian safety or wide crossing distances.

**Industrial streets:** Similar to freight routes, industrial streets are used for loading, shipping and deliveries. They are typically located in industrial areas with lower levels of pedestrian and car traffic.

**Alternative strategies for intersections with frequent large vehicle turns**

Before increasing curb radius dimensions to accommodate necessary design vehicles, consider the alternative measures described here:

**Compound radius:** A compound radius changes the curb radius over the length of the turn, such that it has a smaller radius at the crosswalks, and a larger radius in the center where vehicles are turning. Compound radii effectively shorten crossing distances and make pedestrians visible while accommodating larger vehicles to turn; because they allow more sweeping turns, they do not slow turning vehicles.

Compound radii may be considered where there are high pedestrian volumes, or a desire to make pedestrians visible, but a need for frequent large turning vehicles such as right-turning buses.

**At-grade paving treatments:** To accommodate occasional trucks in very low traffic areas, consider a corner design in which the area between the large and the small curb returns is at street level, and is textured to discourage high-speed turns but allow low-speed use by larger vehicles. This treatment has limited application, such as industrial streets.

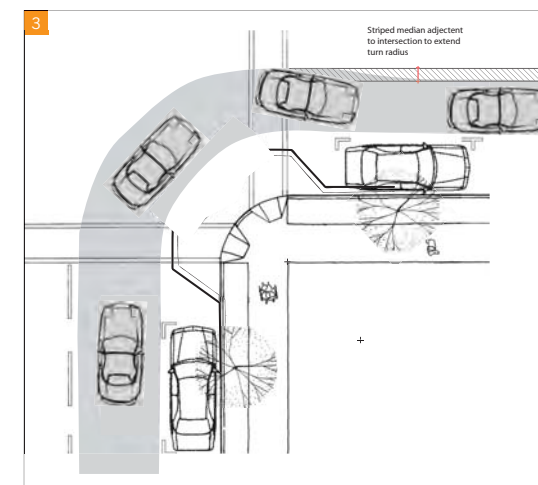
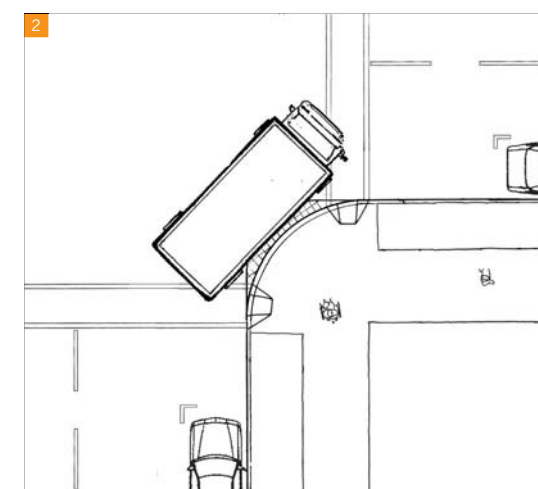
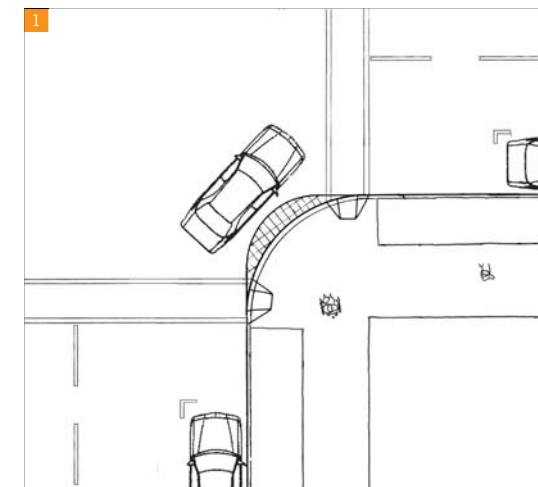
**Advance stop lines:** Advance stop lines on the destination street can increase the space available for large vehicles to make a turn by enabling them to swing into opposing lanes on the destination street while opposing traffic is stopped.

**Painted median:** Where there is sufficient lane width on the destination street, a painted median can enable a large vehicle to complete a turn without turning into opposing traffic.

**Restricted access:** Where there is a desire to keep curb radii small, restrictions on large vehicles making the turn may be considered. This should be considered in light of the overall street network.

CATEGORY	BSP STREET TYPES	DESIGN VEHICLE	ACCOMMODATION VEHICLE*
LOCAL	alley, shared public way, neighborhood residential, local lanes of boulevard	Passenger car	SU-30
PEDESTRIAN-ACTIVITY	neighborhood commercial, downtown commercial, downtown residential	SU-30	WB-40
THROUGHWAY	commercial throughway, residential throughway, urban mixed-use, parkway, through lanes of boulevard	SU-30	WB-40
INDUSTRIAL	industrial	WB-40	WB-50
VARIABLES	park edge, ceremonial	Varies	Varies

\* Accommodations include: turning partially or entirely from adjacent lanes, turning from opposing lanes, or turning into opposing lanes



- ▶ Two strategies to extend effective turn radius.
- 1,2: At-grade paving treatment
- 3: Painted median to extend turn radius



# Curb Extensions (Bulb-Outs)

## 5.3

Curb extensions (also called bulb-outs) extend the sidewalk into the parking lane to narrow the roadway and provide additional pedestrian space at key locations; they can be used at corners and at mid-block locations.

Curb extensions enhance pedestrian safety by increasing pedestrian visibility, shortening crossing distances, slowing turning vehicles, and visually narrowing the roadway. Generally, these benefits are greater the further the bulb-out extends into the roadway and the tighter the turn radius created by the bulb-out, but should be balanced against roadway characteristics and the needs of large vehicles to navigate turns.

Curb extensions can often be lengthened to create public spaces, landscaped areas, or transit waiting areas. They can also be employed as neckdowns or chokers, traffic calming techniques that reduce vehicle travel lanes.

Curb extensions can have the following benefits:

- Increased pedestrian visibility at intersections through improved sight lines.
- Decreased pedestrian exposure to vehicles by shortening the crossing distance.
- Reduced vehicle turn speeds by physically and visually narrowing the roadway.
- Increased pedestrian waiting space.
- Additional space for street furnishings, plantings and other amenities.
- Reduced illegal parking at corners crosswalks and bus stops.
- Facilitated ability to provide two curb ramps per corner.





Although curb extensions have many benefits, they may not be appropriate in all circumstances. Use of curb extensions should consider the following:

- They may be more expensive to construct than other measures.
- They can reduce flexibility of the roadway in construction routing.
- They can reduce future flexibility in making changes to the location of bus zones, roadway lane layout, or crosswalks.

Bulb-outs should also be considered as one among many strategies to enhance pedestrian safety and streetscape character; in some cases, median refuges, raised crossings, other improvements, or a combination of strategies may be more appropriate.

## PLACEMENT

Curb extensions should be considered on all street types. Specific priority areas for curb extensions include:

- new streets;
- streets with high pedestrian volumes and/or high traffic volumes and speeds;
- wide streets with long crossing times;
- streets with a history of pedestrian safety concerns;
- locations where neighborhood streets intersect with busier thoroughways; and
- transit priority streets where shortening crossing cycles would improve transit flow.

Lower priority areas for curb extensions include streets with lower pedestrian and traffic volumes and lower speeds, such as neighborhood residential streets and alleys. However, they may be considered on these street types as well.

Curb extensions should not be used on streets without a parking lane, or that have a peak period tow-away parking lane.

Curb extensions should be placed at transit stops per Section 5.5. Where curb extensions are provided at transit stops, they should be a full-length transit bulb, and not a standard corner bulb, as it can be difficult for a bus to exit or re-enter traffic around a corner bulb-out.

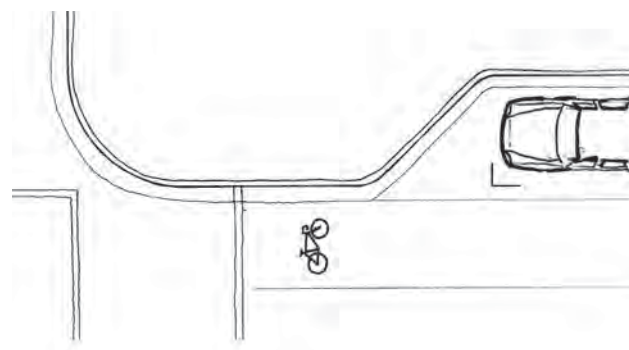
## GUIDELINES

Bulb-outs should be designed to maximize pedestrian space and minimize crossing distances as much as feasible, while allowing vehicle movements as described in Section 5.2.

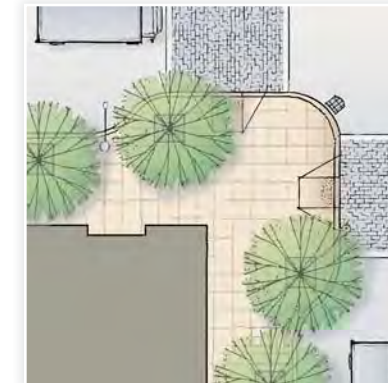
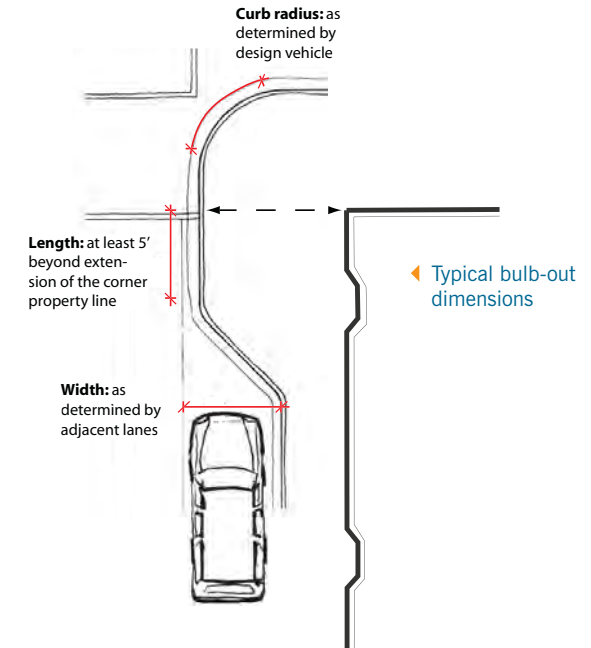
### Width and length

Bulb-out width should be maximized based on space for adjacent vehicle and bicycle travel lanes (see Figure 1). The bulb-out should extend to the full width of the parking lane or leave:

- 10 feet for the nearest auto travel lane;
- 11 to 12 feet for the nearest travel lane if it is a transit lane;
- 12 feet for the nearest travel lane if it is a designated freight route or industrial street; and
- 5 feet or the full width of any adjacent bicycle lanes.



▲ Where bike lanes are present, curb extensions should be set back so that the gutter pan does not extend into the bike lane



Curb extensions can provide usable neighborhood space for community gathering and socializing.





## ➔ Street Sweeping at Curb Extensions

Currently in San Francisco, interior radii at curb extensions are designed with wide, curving radii so that street cleaning machines can access the entire street. While these are preferable from a maintenance standpoint, they result in inefficient use of space, with less space available for pedestrian use and landscaping, greater parking loss, and a less sharply defined curb extension. Neighborhoods with bulb-outs that don't meet street sweeping requirements, such as Duboce Triangle, have some of the most desirable streets in the city.

The Better Streets Plan recommends as an alternative the use of sharper turn radii, such that curb extensions return to the prevailing curb line to make efficient use of space. Given current maintenance practices, the alternative strategies suggested in the text should only be used on streets without mechanical street cleaning, on areas with a low maintenance burden (for example on North-South residential streets with less windy conditions), where maintenance funding or agreements are in place (for example, where CBDs or adjacent merchants or property owners agree to pay for hand street sweeping of corners), or in special cases where the benefit of doing so will outweigh the additional maintenance costs.

**These recommendations require further discussion and study.** Meanwhile, the City should explore maintenance strategies to achieve effective street cleaning at curb extensions with sharp radii, such as expanding the use of maintenance agreements.

▼ Where necessary, driveways can cross curb extensions.



Before reducing the width of the proposed bulb-out, consider modifications to lane striping across the entire roadway to provide for the above-listed clearances. Since bulb-outs are often expensive to construct, they should be sufficiently wide to maximize their benefit. Bulb-outs less than 4 feet in width may not be a cost-effective solution as compared to other potential interventions.

Curb extensions should not encroach on cyclists' space. Where bike lanes use a painted inside edge, the bike lane should be painted continuously as the bike lane passes the curb extension, and the bulb-out should be set back so that the gutter does not extend into the bike lane. On lower-speed and volume streets where bikes can travel in mixed flow with vehicles, wider curb extensions may be appropriate, but care should be taken not to force cyclists to merge unexpectedly with faster moving cars at the end of the block. If bulb-outs extend beyond the limit of parked cars, additional efforts should be made to ensure their visibility.

Bulb-outs should continue at least to the inside edge of the crosswalk, and ideally extend 5 feet beyond the property line before beginning to return to the curb to provide additional width for pedestrians, landscaping, or other streetscape features. Existing driveways may cross through bulb-outs.

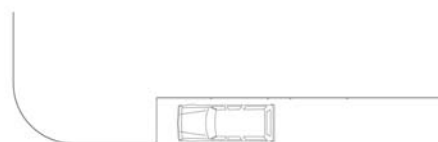
Standard



Alternative (angled return - may be parallel or angled parking)



Alternative (90 degree return - may be parallel or perpendicular parking)



## Radii

Curb extensions should follow corner curb radius guidance in Section 5.2. Where turn radii make adding bulb-outs at each corner prohibitive, strive for two bulbs per intersection, kitty-corner to each other, in order to improve pedestrian conditions for all four crossings of an intersection.

Curb extensions should return to the prevailing curb line as sharply as possible to maximize useable space and minimize parking loss, per the following guidelines:

**Standard return:** Standard bulb-outs should be designed with an inner/outer curb radius of 20' and 10', sometimes reduced to 15' and 10', to enable street sweeping machinery to sweep the entire curbline.

**Non-standard return:** Sharper curb returns increase pedestrian space and minimize parking loss while better defining a curb extension. However, they are more difficult and costly to maintain. Where maintenance funding or agreements are in place to account for this, designs may consider the non-standard treatments described below:

- ➔ **90 degree return:** Curb extensions may return to the prevailing curb line at a 90 degree angle. This configuration may be used with parallel or perpendicular parking.
- ➔ **45 degree return:** Curb extensions may return to the prevailing curb line at an angle. This may be used with either parallel parking (45 degree return) or angled parking (at angle of parking lane).

## ➔ Temporary Bulb-Outs

Temporary bulb-outs may be used in some instances where permanent bulb-outs are cost-prohibitive. These can be created by delineating the edge of a curb extension with bollards, striping, and other elements to protect the extended sidewalk corner without bringing the curb extension up to the sidewalk level. This should be considered a temporary treatment until funding and time allow construction of a standard curb extension.

### ➔ Making Sidewalk Widening and Bulb-Outs More Cost-Effective

Corner bulb-outs and sidewalk widenings are among the most effective tools to enhance pedestrian safety and quality. They are essential components of a truly successful pedestrian environment.

However, they are very expensive to construct, particularly when compared to other potential strategies, which often prohibits their inclusion in pedestrian projects with limited budgets. The high cost of building bulb-outs and widenings comes from various factors, including:

- demolition and reconstruction of curbs;
- re-grading of the roadway;
- curb ramp construction;
- re-alignment of utilities lines and poles;
- more costly re-paving;
- catch basin relocation; and
- fire hydrant relocation.

Some strategies may be considered to reduce costs:

1. Allowing utilities to remain under sidewalk extensions. Per SFPUC policy, sidewalks may be constructed over existing sewer or water lines.
2. Use of trench drains (channels covered with metal grating) to eliminate the need to relocate catch basins or re-grade streets for drainage. Trench drains require additional maintenance to clean out channels, particularly on high-use and commercial streets. See Section 6.2.
3. Allowing fire hydrants to remain in place. Fire hydrant relocation can be prohibitively expensive (\$50,000-\$100,000) when constructing sidewalk bulb-outs or widenings, often resulting in a decision to not construct a particular curb extension. Current Fire Department standards require hydrants to be between 24 and 27

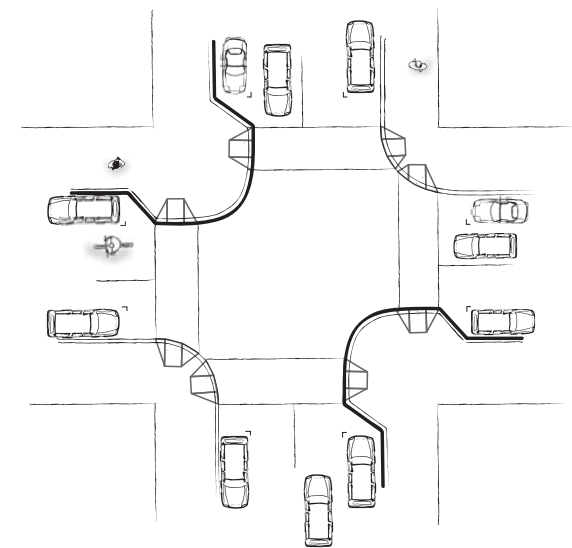
inches from the curb line. When curb lines are moved, hydrants that are present must be shifted as well. Allowing hydrants to remain in place would result in significant cost savings for constructing bulb-outs and widenings. The bulb-outs would also keep the area clear of illegally parked cars, which improves access to the fire hydrants. Instead of moving hydrants, in-street reflectors, painted curbs, and other technologies may be used to make existing hydrants easy to locate. **Follow up discussions with the Fire Department would be necessary to implement this recommendation. The City should seek a solution that addresses the need to easily and quickly locate hydrants while enabling the cost-effective construction of curb extensions with significant pedestrian safety benefits.**



Trench drains may be used to allow pre-existing catch basin locations to be maintained and decrease the potential cost of curb extension construction. See Section 6.2 for appropriate use and design of trench drains.



▲ Curb extensions shorten crossings and can act as a choker, narrowing traffic lanes at intersections to calm traffic, improving pedestrian safety at crossings



▲ Where turning radii limit bulb-out dimensions, consider two bulb-outs at opposite corners, thereby shortening all crosswalk lengths



▶ Mid-block curb extensions



### Shape

Bulb-outs should strive for a rectilinear shape to keep a direct path of travel and to regularize crossings and curb ramps. The adjacent figures show alternative bulb-out shapes with the same turn radius. The figure at left provides greater overall space for pedestrians waiting to cross the street, which may be useful at impacted locations. The figure at right provides more clear directionality and direct curb ramps, as well as a tighter corner. Both alternatives are acceptable; the resulting design should be balanced with the overall goals of the project.

### Other design features

Bollards, planters, or other fixed objects may be placed at the back of curb where necessary to protect pedestrians and prevent vehicles from driving onto the sidewalk.

Curb extensions should be designed to hold the 100-year storm within curb width. Stormwater features can help to offset reduced capacity from curb extensions. Individual analysis should be conducted for each project.

Curb extensions should either relocate the corner catch basin to the outer edge of the extension, or provide a covered channel (trench drain) to convey stormwater to the existing catch basin (see side bar, previous page). The channel must be covered with an ADA-compliant cover.

### EXTENDED BULB-OUTS

Longer curb extensions may be considered to create space for seating, landscaping, stormwater features, and other amenities, particularly in areas lacking in open space. Extended bulb-outs should use special paving or an edging treatment to distinguish the space as a plaza space separate from the through travel area.

Street furnishings and other above-grade objects should be located on curb extensions outside of crossing areas to increase space for pedestrian through travel on the sidewalk.

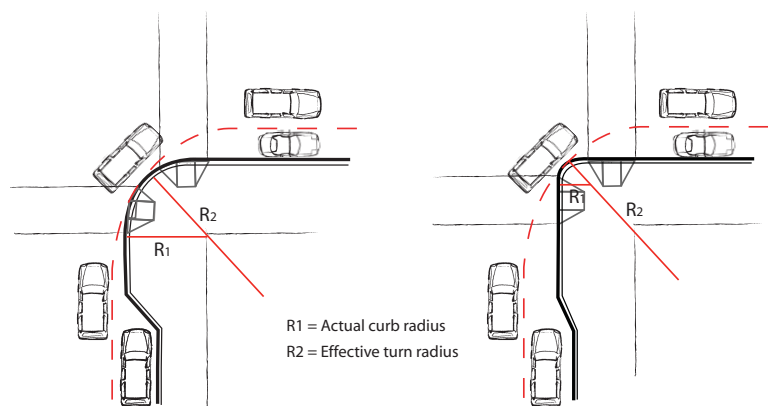
### MID-BLOCK BULB-OUTS

Mid-block bulb-outs may be considered on all street types to provide additional sidewalk space for landscaping, seating, stormwater treatment, and amenities, and improve safety at mid-block crossings by shortening crossing distances and enhancing pedestrian visibility. Mid-block bulb-outs should follow these guidelines:

- They should include bollards, landscaping, or other buffers between pedestrians and passing vehicles, designed to not impede a driver's view of pedestrians.
- They should use special paving or an edging treatment to distinguish the space as a plaza space separate from the through travel area.
- Street furnishings and other above-grade objects should be located on curb extensions where space allows to increase space for pedestrian through travel on the sidewalk.
- Mid-block curb extensions should be used at designated mid-block crossings. Mid-block crosswalks should be provided per Section 5.1.

The City should explore the use of curb extensions in front of fire hydrants so that the hydrant is not blocked by illegally parked vehicles. This would require a change to current City standards regarding location of fire hydrants relative to the curb. See sidebar.

- ▶ Mid-block bulb-outs can provide space for landscaping, cafe seating, or pedestrian furnishings.



Option 1: A shorter crossing and larger overall bulb-out

Option 2: Greater directionality and sharper curb radius

▶ Bulb-out shape alternatives





Medians and islands can calm traffic and provide safe pedestrian refuge, while incorporating space for amenities, landscaping and stormwater management



# Medians and Islands

## 5.4

A median is the portion of the roadway separating opposing directions of the roadway, or local lanes from through travel lanes. Medians may be depressed, raised, or flush with the road surface. Medians are generally linear and continuous through a block. An island is defined as an area between traffic lanes used for control of traffic movements. Within an intersection, a median is considered an island.<sup>1</sup>

Raised medians and islands provide space to locate pedestrian safety features and traffic control devices, amenities, landscaping and stormwater management. They can provide traffic calming and aesthetic benefit, but the addition of medians alone may also cause an increase in vehicle speeds by reducing friction between opposing directions.

The functions and benefits of medians include:

- separate opposing traffic;
- provide a recovery area for out-of-control vehicles;
- provide an emergency stopping area;
- provide space for speed changes and storage for left- and u-turns;
- minimize headlight glare;
- restrict through travel on streets with two-way left turn lanes or where cross streets intersect with more significant throughways;

<sup>1</sup> AASHTO Green Book





- provide space for a pedestrian refuge on wide streets where those on foot cannot cross the entire street in one phase;
- reduce excessive pavement areas, and provide open green space;
- provide space for transit stops;
- separate through traffic from local traffic on multi-way boulevards; and
- create space for a distinctive design treatment.

Where no median is present, raised islands can be used as traffic calming features to briefly narrow the traveled way, either in mid-block locations, or to create gateways at entrances to residential streets. Islands may also be found at corners.

## GUIDELINES

At crossings, the end of medians should be flush with the edge of the crosswalk and should not be significantly rounded. A thumbnail, or raised island on the intersection side of the crosswalk, should be provided in medians that function as pedestrian refuge islands.

- ▼ Landscaped medians provide visual continuity to a corridor



- ◀ Median islands can designate entrances to residential streets

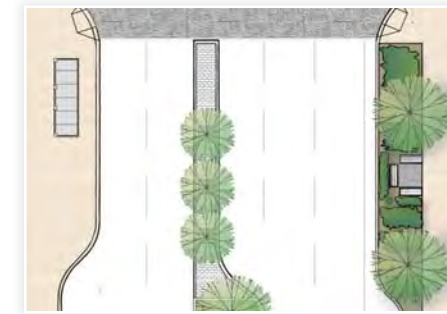
Medians may be combined with parking lane planters, chicanes, bulb-outs, or other traffic calming measures where it is desirable to further moderate traffic speed.

Medians and islands more than 3 feet wide, including curbs, should be landscaped and used for stormwater management. When street trees are desired, a median should be a minimum of 5 feet wide, including curbs, to provide sufficient space for healthy root growth per Sections 6.1 and 6.2.

As budgets allow, medians should be built to the maximum width possible, rather than providing a striped area outside the median. Landscaped medians should be configured so that maintenance personnel do not have to work in traffic lanes, by providing a minimum 2 foot walkable edge or striped area adjacent to the median.

Design and landscaping of medians should emphasize continuity on throughways and ceremonial streets. Landscaping, lighting and street furnishings should maintain a similar look and feel even as the corridor varies in land use, scale and intensity. On neighborhood streets, they may have a more flexible, organic design.

Islands should not interfere with driveway access, unless that is the purpose of the installation (i.e. access management).



Medians provide space for trees and planting, visually break down the scale of the right-of-way, and create space for pedestrian refuges.



## ➔ Stormwater Management in Medians

Landscaped medians reduce impervious space in the roadway, allowing stormwater infiltration or retention in the exposed soil. Medians can also be designed to retain, cleanse, and infiltrate stormwater runoff from the roadway. Where stormwater management is intended in the median, the street should be graded to drain toward the median. For more information on stormwater management, see Section 6.2.





Pedestrian refuges provide space for pedestrians to wait on longer crossings and may include pedestrian amenities.

### PEDESTRIAN REFUGE ISLANDS

Pedestrian refuge islands are protected areas where people may safely pause or wait while crossing a street. Pedestrian refuge islands are particularly helpful as resting areas for seniors, persons with disabilities, children, and others who may be less able to cross the street in one stage. At signalized intersections, they allow slow moving pedestrians to cross in two phases. At unsignalized locations, they simplify the act of finding a gap in traffic to cross since vehicles from only one direction must be reckoned with at a time.

Raised pedestrian refuge islands can be provided in painted center medians, side access lane medians, transit boarding islands (Section 5.5), and corner islands.

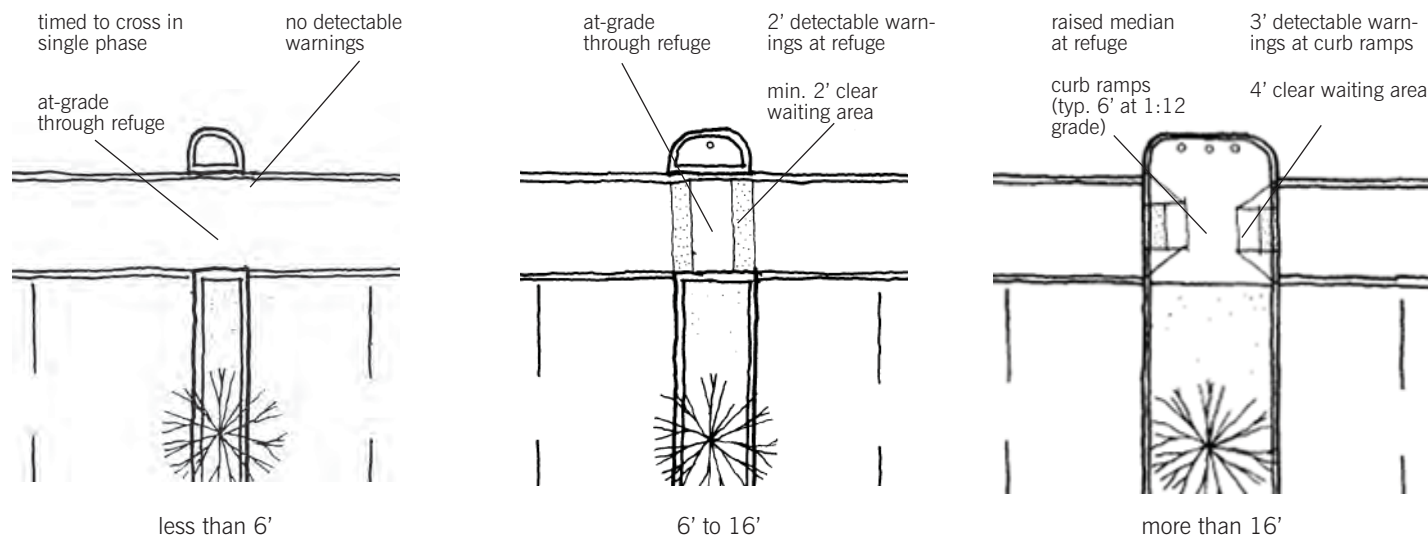
### Placement

Pedestrian refuge islands should be considered under the following conditions:

- streets with high pedestrian activity;
- where crossing distances are long (60 feet or greater);
- near and within neighborhood retail areas, civic and institutional uses, schools and senior facilities;
- locations with many transfers between transit lines; and
- unsignalized intersections with large numbers of pedestrians.



▼ Median design at various widths



### Choosing Median Refuge Islands vs Curb Extensions

Pedestrian refuge islands and curb extensions both improve comfort and safety for crossing pedestrians. Curb extensions minimize the distance needed to cross wide streets and facilitate crossing in one stage, while pedestrian refuge islands offer a comfortable resting place between crossing stages. Pedestrian refuge islands are typically significantly cheaper to construct than bulb-outs.

Under the following conditions, median refuge islands may be preferable to curb extensions, or it may be possible to use median refuge islands in addition to curb extensions:

- two-way left-turn lanes;
- excessively wide travel lanes or turn lanes;
- 4 lanes or more where it is may be difficult to cross in one stage;
- a ceremonial purpose, where medians provide an important design function; and
- an existing median.

### Dimensions

On streets with medians less than 6 feet wide, signals should be timed so that pedestrians can cross in one signal phase and detectable warning strips are not required.

On medians between 6 and 16 feet wide, the pathway and waiting area should be at street grade, with a row of 2 foot wide detectable warning strips on each end, leaving a 2 foot wide clear zone in the center.<sup>1</sup>

On medians 16 feet wide or greater, pedestrian refuge islands should be raised to provide more visibility for waiting pedestrians. Raised islands should include two ramps (typically 6 feet wide) with 3 foot wide detectable warning strips on each end and a minimum 4 foot wide waiting area.<sup>2</sup> See graphic.

### Safety and Design Elements

In order to protect waiting pedestrians, the following elements should be used in pedestrian refuge islands:

- Raised thumbnails should be provided on the intersection side of refuge islands, ideally outside of the crosswalk edge.



- To accommodate turning radii for large vehicles, the thumbnail may need to be within the crosswalk, or have a mountable outside edge.
- A bollard, landscaped feature, or sign should be provided on the thumbnail, unless it is a mountable thumbnail. These features should be 2 to 4 feet tall. Taller elements such as light fixtures or sign poles may be appropriate if they are thin enough to not obscure drivers' view of pedestrians.
- Pedestrian refuge islands should use different paving (concrete or other) in order to distinguish them from the roadway. See Section 5.4: Paving.
- On wider medians, a seatwall or other amenities may be provided

### CORNER ISLANDS

Where the pavement area within an intersection becomes excessively large as a result of efforts to accommodate turning movements of large vehicles or due to streets coming together at unusual angles, adding corner islands can help control traffic and break up the crossing for pedestrians.

Adding corner islands creates a “slip lane”, which separates right turning vehicles from through traffic. Slip lanes can be stop- or signal-controlled, but are often yield-controlled.

Slip lanes and the very large corner radii that come with them can pose a hazard to pedestrians for a number of reasons:

- Drivers tend to concentrate on merging with oncoming traffic and may not see pedestrians entering the crosswalk.
- In high-traffic areas, inadequate gaps in uncontrolled right-turning traffic may exist, making crossing a slip turn lane difficult for pedestrians.
- The non-standard corner geometry introduced by slip lanes is difficult for people with visual impairments to negotiate.

<sup>1</sup> Source: Access Board, Draft Public right-of-way Accessibility Guidelines (R305.4.2)  
<sup>2</sup> Source: AASHTO ped guide

### ➔ Offset or ‘Corral’ Crosswalks

Offset crosswalks are treatments in which the crosswalk is split by a median and is offset on either side of the median. This design forces pedestrians to turn in the median and face oncoming traffic before turning again to cross the second half of the roadway, which may improve safety, especially where there is no signal control at mid-block and T-intersection locations.

While offset crossings provide safety benefits, they may inconvenience or delay pedestrians. Wherever feasible, pedestrians should be given sufficient time to cross the entire roadway in one phase. However, two-phase crossings may occasionally be unavoidable, and in some cases may benefit transit.

Unless offset crosswalks provide tactile cues for visually impaired pedestrians to re-orient themselves before crossing the second half of the roadway, pedestrians navigating with a cane may be misdirected. Offset crosswalks should be built so that each side of the median pass through features a curb running parallel to the crosswalk, forming a “Z”.

In order to discourage shortcutting and encourage pedestrians to follow the intended path, some staggered crosswalks include a railing to contain pedestrians and direct them along the desired route, called a corral-crossing. Corral crossings should be avoided. Care should be taken to design a pleasant walking environment that does not make pedestrians feel like barnyard animals. A low seatwall or landscaping may provide an attractive alternative where a physical barrier higher than a curb is necessary.

- ▼ Offset crossings should minimize inconvenience to pedestrians. The photo on the right would benefit from a feature to redirect people with visual impairments to the direction of the crosswalk.



Source (right image): [http://www.contextsensitivesolutions.org/content/case\\_studies/mid-block-crosswalks-school-zone-olympia-wa/#](http://www.contextsensitivesolutions.org/content/case_studies/mid-block-crosswalks-school-zone-olympia-wa/#)





Slip lanes and corner islands should be avoided and removed to create additional pedestrian space wherever possible.

Where the large turning radius provided by a slip lane proves unnecessary, the slip lane should be removed and the corner added to the sidewalk area. This reclaimed space can be made into an attractive pedestrian plaza with furnishings and plantings.

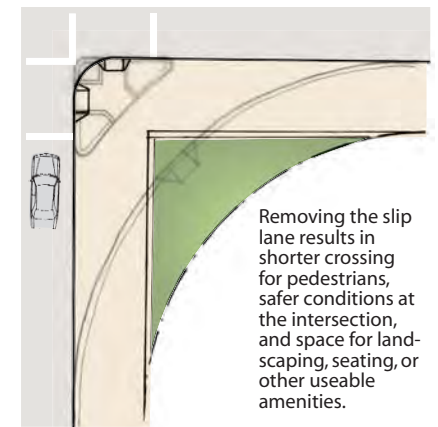
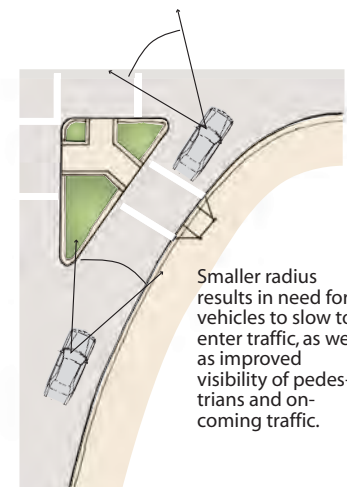
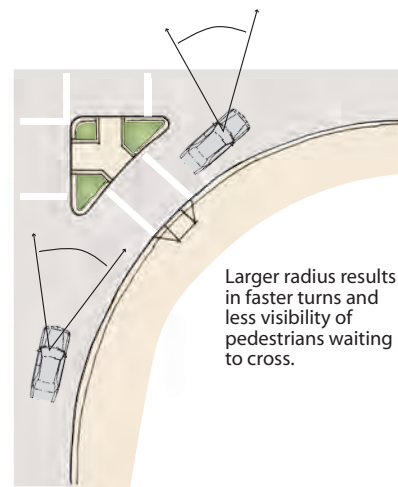
At intersections with very high right turning volumes or which must accommodate very large vehicles, slip lanes may be unavoidable. Where it is not possible to avoid or remove slip lanes, their design should be mitigated, per the following guidelines:

- For maximum pedestrian benefit, slip lanes should be designed with a maximum 30-35 foot turning radius; however, they should follow the guidance in Section 5.2.
- Slip lanes should incorporate additional pedestrian safety measures. Signaling the right-turn movement creates gaps in vehicle traffic for pedestrians and may be the safest alternative. Crosswalk treatments, such as warning signage, special paving in the slip lane, or a raised crosswalk connecting the sidewalk with a refuge island, may also improve conditions for pedestrians. Slip turn design may employ a compound radius to slow vehicles and improve drivers' visibility. See Section 5.2 for discussion of compound curb radii.



→ Raised islands should include a pedestrian refuge

→ Uncontrolled slip turn lanes, especially those that turn into a dedicated exit lane (free right turn slip lanes), are discouraged where pedestrians are present



- ◀ 1. Center median
- 2. Corner island
- 3. Side median with pedestrian refuges



A vintage trolley is the central focus of the image, positioned on a city street. The trolley is light-colored with large windows and a sign that reads "FISHERMAN'S WHARF". Below the sign, the number "18-93" is visible. The trolley's doors are open, and several people are standing on the sidewalk, some looking towards the trolley. The background shows a city street with buildings and trees. The overall scene is in black and white, with a semi-transparent text overlay on the right side.

Transit supportive streetscape design includes safe, comfortable transit waiting areas, convenient routes to transit, and design to enhance pedestrian and transit circulation.



# Transit-Supportive Streetscape Design

## 5.5

Transit stops enhance the experience of waiting for and boarding transit vehicles. Successful transit stops are well connected to the local network of sidewalks and pedestrian routes, and provide convenient connections to residences, work places, and other destinations.

Streetscape elements and pedestrian facilities should be designed to support transit operations. Streetscape designs that benefit pedestrians are often helpful to transit as well.

### TRANSIT STOPS

#### Placement

Sidewalk transit stops should be located in a curb extension wherever possible, per guidelines below. Transit stops should be located in median islands where transit uses center lanes.

At signalized intersections, transit stops should typically be located at the far side of intersections to facilitate bus operations, transit signal priority, and pedestrian movement. This also enables the crossing to be located behind the bus, which is preferable for pedestrian safety. At stop signs, transit stops should typically be located near side. See SFMTA's stop location guidelines for more details.

Transit stops should be located in places that are active and visible to maximize personal security of waiting transit users.

Transit stops should not be located at driveways wherever possible; new driveways should be discouraged at transit stops (and generally along major transit routes).



Layout

Good layout of a transit stop offers transit patrons visual cues on where to wait, clearly defines the transit stop and calls it out as a special place in the sidewalk environment, allows ease of access between the sidewalk, the transit stop, and the transit vehicle, and does not block the path of travel on the adjacent sidewalk.

Transit stops should abide by the following layout guidelines:

- Streetscape elements should be consolidated to create clear waiting space and minimize obstructions between the adjacent sidewalk, waiting areas, and boarding areas.
- Streetscape elements should be evenly spaced throughout the transit stop for ease of access. They should be aligned for ease of detection by people with visual impairments.
- Transit stops may be distinguished from the adjacent sidewalk through the use of special paving treatments, curb extensions, or a row of trees or planters, where space allows. Use of a different species of tree than the prevailing block pattern can help to differentiate the transit stop. These treatments are most appropriate on the Muni Rapid Network or at major transfer points.
- Transit stops should be integrated with adjoining activity centers wherever possible to activate and create a safe space.



Muni's approved transit shelter design

Transit stops must include the following accessibility features:

- A clear 5 foot by 8 foot loading area perpendicular to the curb, with a maximum 2% cross-slope, to allow a transit vehicle to extend its ramp to load people with mobility impairments. The clear loading area should be at the front of the boarding zone and accessible from the transit shelter (where present) and adjacent sidewalk. If a zone is designed for more than one bus, a wheelchair loading zone should be provided for each vehicle.
- A 30 inch by 48 inch clear floor wheelchair space within the transit shelter (where present). This space must be accessible from the sidewalk and the loading area. In some cases, this may necessitate removing one of the panels at the rear of the transit shelter.
- Where boarding platforms are not level with the sidewalk, an accessible ramp must be provided from the sidewalk to the platform.

Transit-Specific Streetscape Elements

Transit-specific streetscape elements should be located within transit stops as follows:

Flag signs should be placed near the front of the stop, to indicate where passengers should wait to board the vehicle. At far side or mid-block stops with bus zones, the flag sign should be placed approximately 25 to 35 feet behind the front of the stop to allow for the bus to pull out of the stop and re-enter traffic. At near side zones, or where there is a transit bulb-out or boarding island, this setback is not necessary.

Transit shelters should be located toward the front of the stop to indicate where customers should wait to board the vehicle. The shelter should be placed approximately 25 feet behind the front of the stop to allow for an accessible boarding area (5 feet by 8 feet) and for the bus to pull out of the stop (approximately 20 feet). Where there is a transit bulb-out or boarding island, the first 20 feet of setback is not necessary.

➔ The Transit Effectiveness Project (TEP)

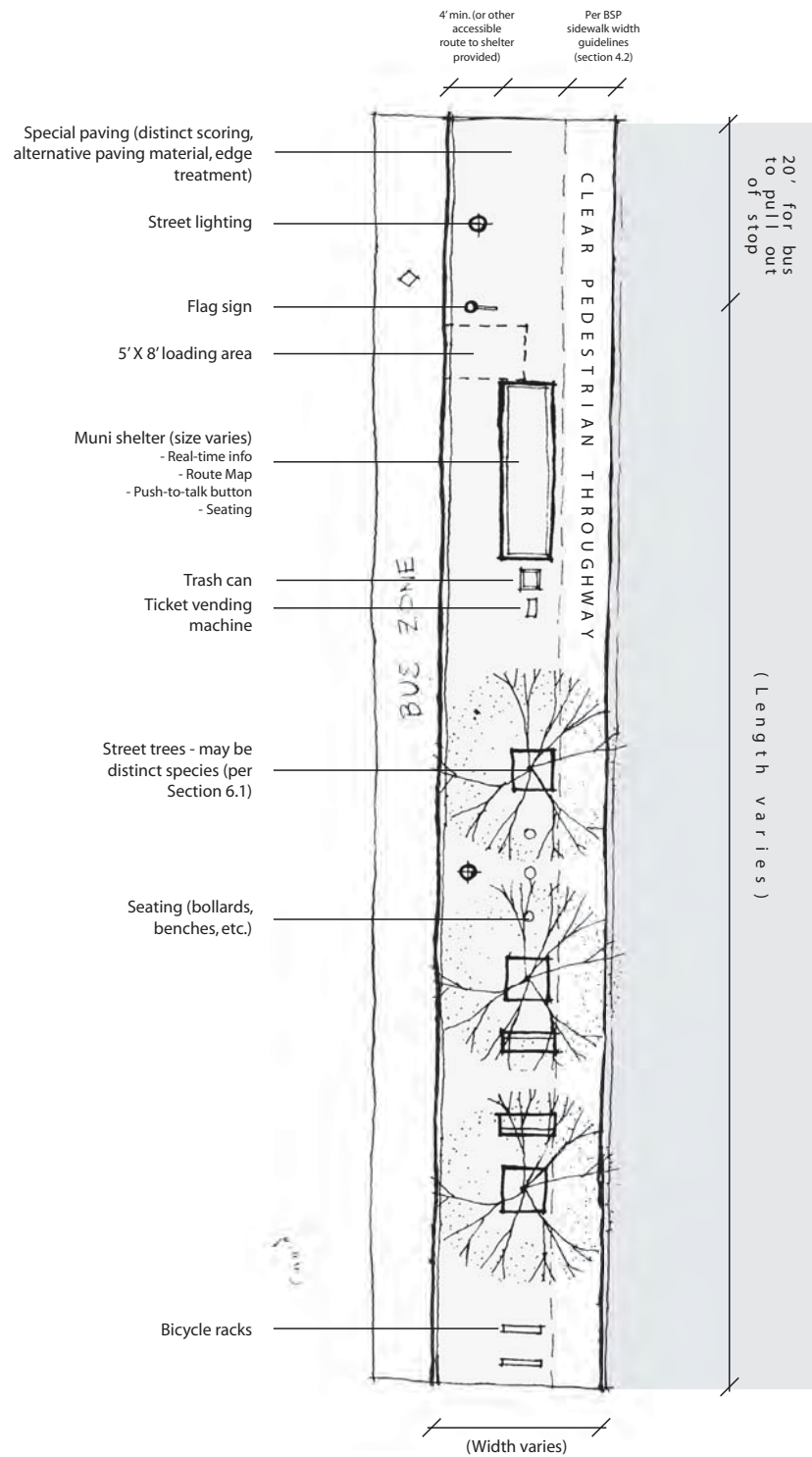
The Transit Effectiveness Project (TEP) is a comprehensive effort to review Muni and recommend ways to create a faster, more reliable and more efficient public transit system for San Francisco. Launched in May 2006, the TEP gathered significant ridership data, studied best practices from other transit systems, and conducted extensive public outreach. Informed by these efforts, the TEP developed a set of preliminary proposals designed to improve reliability, reduce travel delay, and update routes to better meet current and projected travel patterns throughout the City. The SFMTA Board of Directors endorsed the TEP recommendations in October 2008.

The Draft TEP recommendations describe a Muni service framework, based on ridership and frequency of routes. The recommendations focus on providing resources where they are most needed. This includes new routes and route extensions, more service on busy routes and elimination or consolidation of certain routes or route segments with low ridership. The framework categorizes Muni routes into "Rapid," "Local," and "Community" lines, and "Special Services". These terms are referenced in this document.



- ▲ Transit stops should include sidewalk treatment, better circulation, a clear flag sign, pedestrian lighting, trees, and amenities to create a safe and pleasant waiting experience.





▲ Generalized transit stop layout

Transit shelters should be provided where existing sidewalk space allows or where a curb extension can be added to provide sufficient space, and demand warrants. They should not be provided where sidewalk width is insufficient to accommodate a shelter and at least the minimum required clear path of travel around the shelter (per Section 4.2) or the ability to carry expected pedestrian volumes.

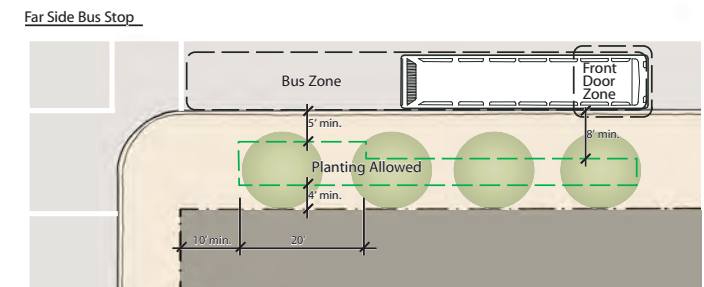
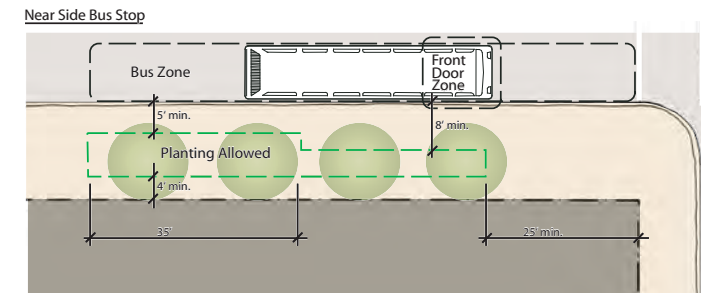
Shelters should be located in the furnishings zone wherever possible. They should be located to provide at least 4 feet of clear space between the edge of the curb and the front edge of the shelter, or another accessible path to the shelter should be provided (for example, by removing one of the back panels of the transit shelter). Alternately, shelters can be placed in the frontage zone so long as they don't block building entrances, but should leave the minimum required clear sidewalk width per Section 4.2.

Transit shelters must use the approved Muni transit shelter design, including real-time transit information, route maps, and a push-to-talk button. Exceptions may be considered for LRT or BRT lines to give these lines a distinct character.

Transit shelter widths vary, from 3 feet to 7 feet in width and 8 feet 6 inches to 16 feet 6 inches in length. Transit shelters should be selected to fit the sidewalk context—on narrower sidewalks, narrower shelters should be used to allow pedestrians to pass freely behind. Larger shelters should be used on LRT, BRT, or Rapid Network lines, or at major transfer points where passenger demand is high.

When modifying sidewalks at existing or new transit stops, evaluate adding electrical systems to provide power for shelter amenities such as lighting and real-time information

Ticket vending machines (TVMs), where provided, should be located near to transit shelters within the transit stop. At transit stops where a proof-of-payment (PoP) zone is used, ticket vending machines should be placed outside the paid zone, not next to the transit shelter (see sidebar).



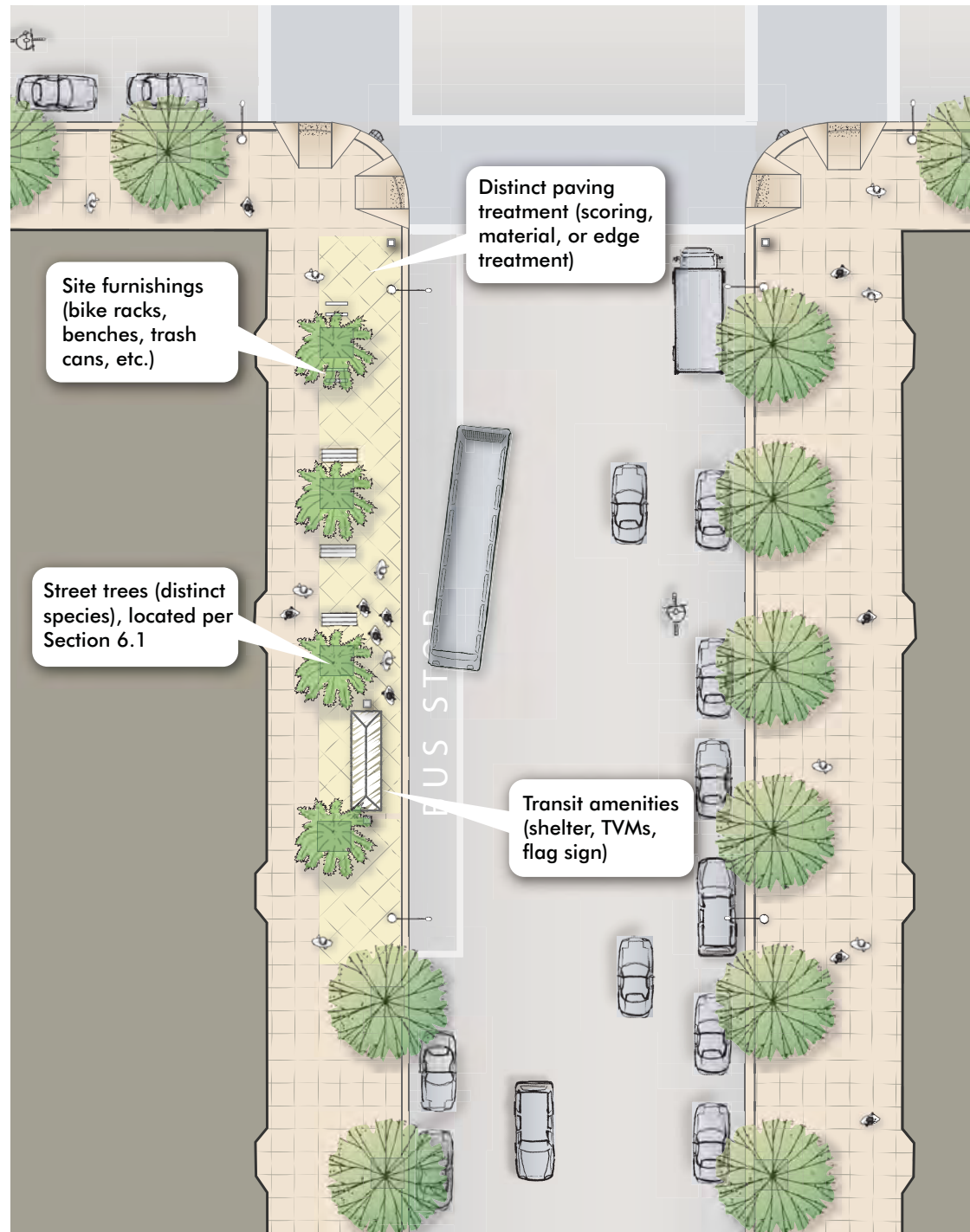
▲ Tree planting in bus zones. See also Section 6.1.

### Other Streetscape Elements

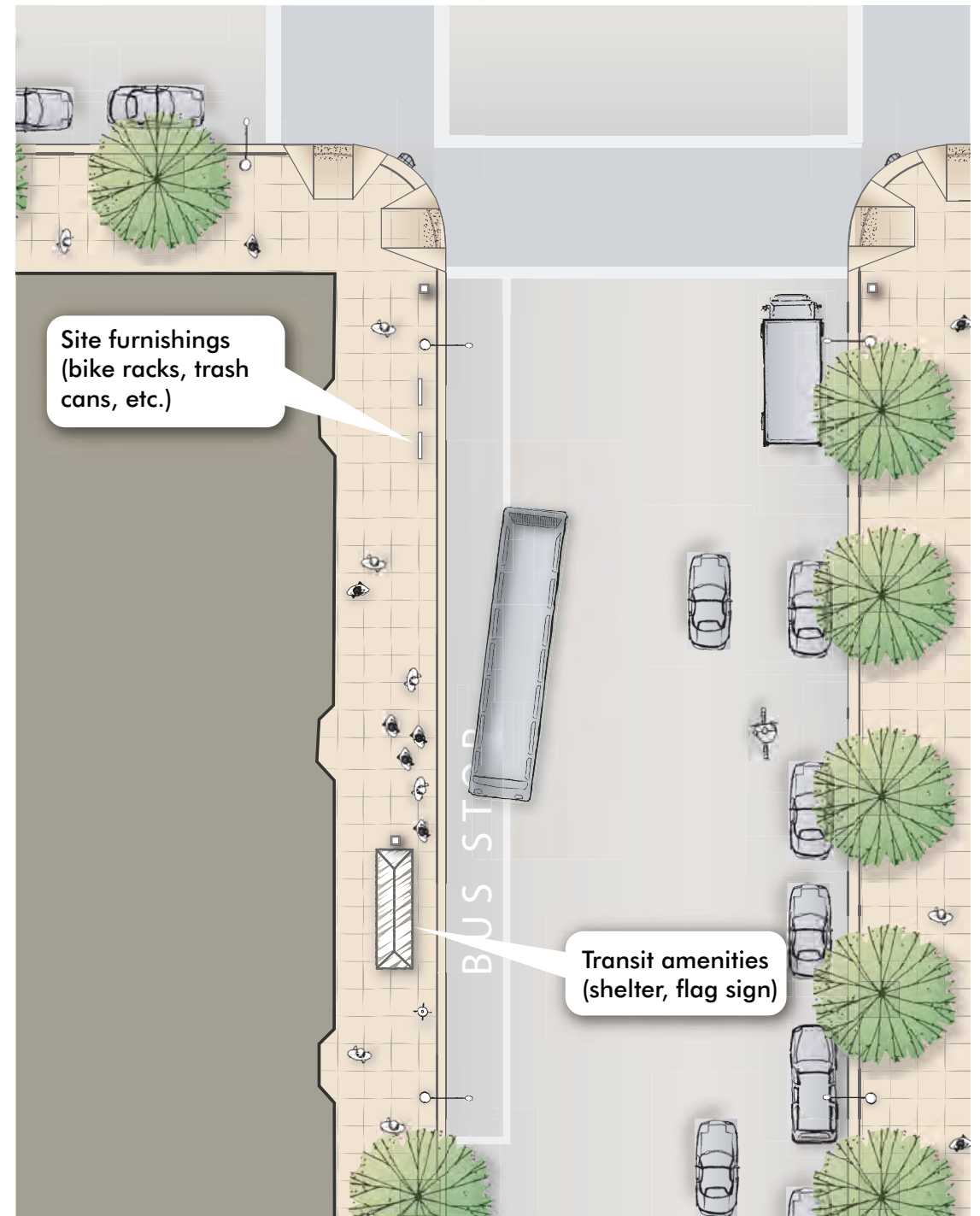
Transit stops and their surrounding area deserve a higher than average level of streetscape amenities to serve waiting passengers. Streetscape amenities should use the following guidelines:

**Urban Forest:** Trees and planters may be used to distinguish the transit stop from the adjacent sidewalk area or to continue the prevailing pattern of tree planting along a block, but should not interfere with transit operations or pedestrian travel. See Section 6.1 for the correct placement of trees and landscaping at transit stops.

This may often mean that, where space allows, street trees in a transit stop would not be along the same alignment as trees on the rest of the block. This can help call out the transit stop as a special location on the sidewalk; in these cases, selecting tree species distinct from the prevailing tree species on the street can enhance this effect. This treatment is most appropriate on LRT, BRT, or other Rapid Network lines, or at major transfer points.



▲ Muni Rapid Network station (typical)



▲ Muni Local Network station (typical)



## ➔ Proof of Payment (PoP) Stations

At some surface transit stations (typically BRT or LRT stops), a proof-of-payment system may be used, with a paid zone inside which patrons are required to have proof of payment (transit ticket or pass). The paid zone may be limited to the vehicle, or it may be a waiting area on the sidewalk or boarding island, similar to the area in subway stations inside the fare gates. Patrons without a transit pass would purchase a ticket through a machine at the entrance to the station and then wait in the boarding area. Those patrons on the boarding area without a pass or ticket would be subject to fines.

Special considerations for PoP stops include:

- The paid zone should be differentiated from the sidewalk or median, using design elements such as special paving, grade changes, planters, bollards or other features. This may or may not include literal gates or turnstiles to enter the paid zone.
- Paid zones should allow permeability to the adjacent sidewalk to enable transit passengers to easily enter the zone (passengers should not have to take a circuitous route to enter the paid zone), but create distinct entry points that make it clear to sidewalk users that they are entering a paid transit area.
- TVMs should be located at the entrance to the paid zone, not adjacent to the transit shelter. Stations may need to incorporate a forecourt area outside the paid area with TVMs at the inner (station entrance) end to avoid congestion in crosswalks or at corners resulting from queuing at TVMs.



▲ A proof-of-payment bus stop in Portland, OR

**Stormwater:** Stormwater facilities may be located within transit areas; however they should not impede the ability to access the transit shelter (where present), or boarding areas. Stormwater facilities appropriate to transit stops include permeable paving in the sidewalk area, building-adjacent planters, or covered channels. See Section 6.2.

**Lighting:** Lighting should be located to illuminate the transit stop area, particularly the front of the stop and the transit shelter (where present). Lighting may be integral to the transit shelter, or may be provided by standard pedestrian or roadway lighting, where sufficient. See Section 6.3.

**Paving:** Special paving may be provided to distinguish the transit stop area from the adjacent sidewalk. Special paving may include a unique scoring pattern, a contrasting paving material, or a paving edge treatment delineating the edge of the transit stop. Special paving may be expensive, and is most appropriate at major stops on LRT, BRT, or other Rapid Network lines or at other major transfer points. See Section 6.4.

**Site furnishings:** Other site furnishings should be located within transit stops as follows. Individual site furnishings should follow the design guidelines in Section 6.5.

- ➔ Seating should be located within the transit shelter (where present). Additional seating, either formal (benches, seats with armrests) or informal (bollards, low seat walls, leaning bars), may be placed outside of the shelter, provided it allows permeability to and from the transit shelter and boarding area.
- ➔ Trash cans should be placed adjacent to the transit shelter (where present).
- ➔ Bike racks, where provided, should be placed near the back of the transit stop (further from the shelter - where present), or be placed outside of but adjacent to the transit stop. Bike-sharing pods, where provided, should be placed outside of but adjacent to the transit stop.
- ➔ Wayfinding information may be located within transit stop areas, particularly in downtown, commercial, or touristed areas.

## DESIGN BY TYPE OF TRANSIT ROUTE

Service amenities and design should be consistent across service categories (Rapid, Local, Community) to increase the legibility of the Muni system. Transit stops on LRT, BRT, or other Rapid Network corridors and at major transfer points should include a greater level of features and amenities than other locations. LRT, BRT, and other special lines should be designed to have a distinct identity and be “branded” to emphasize their special nature. Special treatments for transit stops along these lines may include special signage, unique transit shelters, TVMs, special paving or landscape treatments, premium materials, and higher numbers of amenities at each stop.

At major transfer stops, stop design should facilitate clear, safe, and comfortable transfers. Designs may include wayfinding signs, real-time transit information, a clear path of travel between stops, a consistent paving treatment, or other visual cues to link facilities. Appropriate pedestrian safety measures, such as high visibility crossings, curb extensions, or pedestrian-priority signal timing (see Section 5.1) should be prioritized at major transfer points.

See Figure 5.1 for appropriate amenities by type of transit route.

FIGURE 5.1  
STREETScape AMENITIES BY TYPE OF TRANSIT ROUTE

TYPE OF TRANSIT ROUTE	APPROPRIATE AMENITIES (GENERAL)
LRT, BRT, RAPID NETWORK	Flag sign, trees or containerized planters, lighting, special paving, seating (formal or informal), trash cans, bicycle racks, wayfinding information, real-time transit information, transit shelters and seating (at major transfer points)
LOCAL NETWORK	Flag sign, transit shelter, real-time transit information, trees or containerized planters, lighting, trash cans
COMMUNITY NETWORK	Flag sign, trees or containerized planters, lighting, trash cans
SPECIAL SERVICES	Share stations with above

## TRANSIT BULB-OUTS (BUS BULBS)

Bus bulbs are curb extensions that serve a transit stop. Bus bulbs can improve transit performance by eliminating the need for transit vehicles to exit and re-enter the flow of traffic at each stop. They also facilitate accessible boarding as the bus can align directly with the curb. Bus bulbs improve pedestrian conditions by providing extra space for waiting and passing pedestrians and providing a space to locate transit shelters out of the way of pedestrian flow.

### Placement

Bus bulbs should be considered on all streets with side-running transit and a parking lane, except:

- where there is a peak period tow-away parking lane;
- where there is a desire to have a queue jump lane for buses; and
- at near side stops with heavy right turn movements.

Bus bulbs should be prioritized:

- on Rapid Network lines and major transfer points;
- where existing sidewalk width is too narrow to accommodate a transit shelter, or where pedestrian through travel is constrained; and
- where transit performance is slowed significantly due to the time delays caused by reentering traffic flow, and a bus bulb will mitigate this problem.

Bus bulbs have traditionally been placed on streets with two or more lanes per direction so that vehicles may pass a stopped bus on the left. Bus bulbs may also be considered on streets with one lane in each direction, subject to a case-by-case evaluation. Where they are placed on streets with one lane in each direction, they may be staggered to allow space for vehicles to pass a dwelling bus.

At flag stops with no bus zone, pedestrian bulbs could be extended to reach the front door of a boarding bus at near side stops.

Due to the high cost of constructing and removing bus bulbs, the ultimate stop spacing for a route should be determined prior to their installation, as stops may be shifted or consolidated. Check with SFMTA.

### Guidelines

Bus bulbs should follow the transit stop layout guidelines above. They should follow the curb dimension guidelines for curb extensions specified in Section 5.3.

Bus bulbs should be long enough to accommodate all doors of transit vehicles that will load and unload at the curb extensions plus an additional 5 feet of maneuvering space. Where there is frequent service, such as on BRT or Rapid Network lines, they should be long enough to accommodate two or more vehicles, with a 5 foot space in between. They should leave 10 feet at the back of the bus zone to prevent following cars from blocking the intersection.

Where bus bulbs are provided, streetscape elements including street trees may continue along the same alignment as the rest of the block. The bus bulb may use special paving treatments or distinct tree species to distinguish it from the adjacent sidewalk.

### ➔ Bus Bulb and Boarding Island Lengths for Current MUNI Vehicles

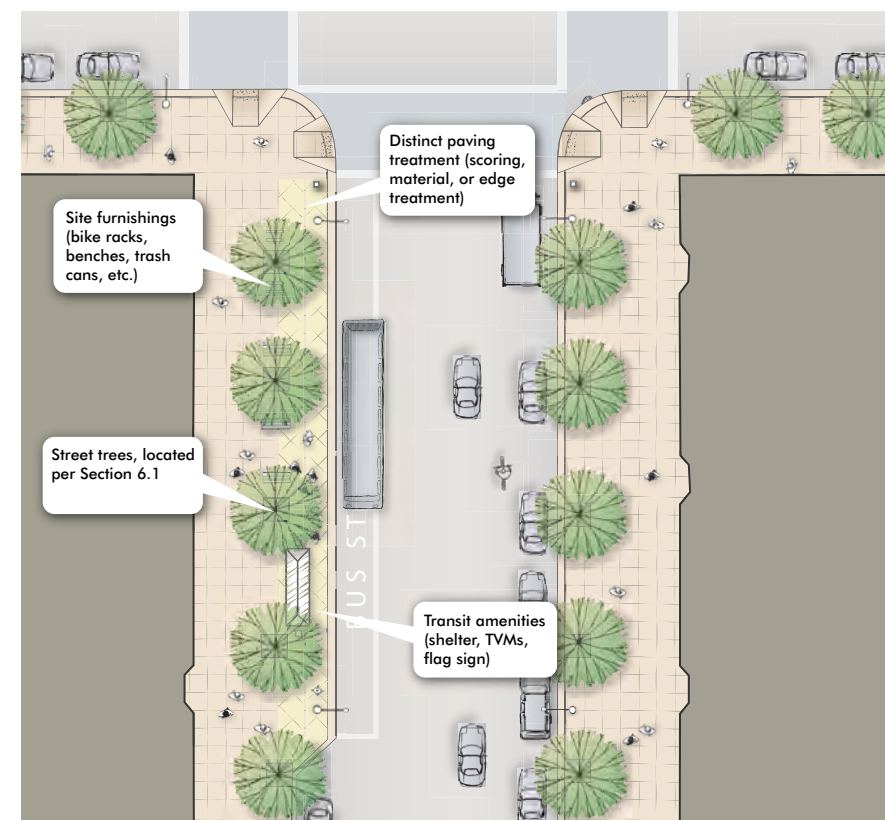
- LRT vehicles (two-car train): 155' near side; 150' mid-block; 165' far side
- 1 Standard 40' bus: 35' near side; 45' far side
- 1 articulated 60' bus: 55' near side; 65' far side
- 2 standard buses: 80' near side; 90' far side
- 2 articulated buses: 120' near side; 130' far side

These requirements may change as Muni vehicle technologies change.



▲ Bus bulb-outs improve transit performance by allowing transit vehicles to load from the travel lane.

▼ Bus bulb-out (typical)







Source: Mike King



Source: Nelson\Nygaard

- ▲ Transit boarding islands are necessary wherever transit runs in center lanes.

## TRANSIT BOARDING ISLANDS

Transit boarding islands are waiting areas located on a median. Transit boarding islands can improve transit performance where vehicles run in the center lane, and do not have to exit and re-enter the flow of traffic at each stop. On multi-way boulevards with transit running in center lanes, the side medians should act as transit boarding islands.

Transit boarding islands may also improve pedestrian conditions by locating the transit waiting area and transit shelter outside of the primary sidewalk. However, sidewalk stations are typically preferable to boarding islands for pedestrians as they are connected to the primary pedestrian system and adjacent to land uses and activities – boarding islands should only be used where transit runs in center lanes.

### Layout and Amenities

Transit boarding islands should follow the transit stop layout guidelines above. They should follow the guidance for medians in Section 5.4.

In addition, transit boarding islands should use the following guidelines:

Amenities such as shelters, seating, signage and TVMs should have a small profile and be arranged along the back edge of the median. Transit shelters should be transparent and should leave 4 feet of clearance in front; this may require removing the sidewalls of the shelter to enable people to pass in front of the shelter.

Boarding islands should include dividers between the island and side travel lanes between the island and the curb. Dividers should be designed to contribute to the overall aesthetic of the station. Where traffic speeds and volumes are low, dividers may not be necessary, subject to engineering judgment.

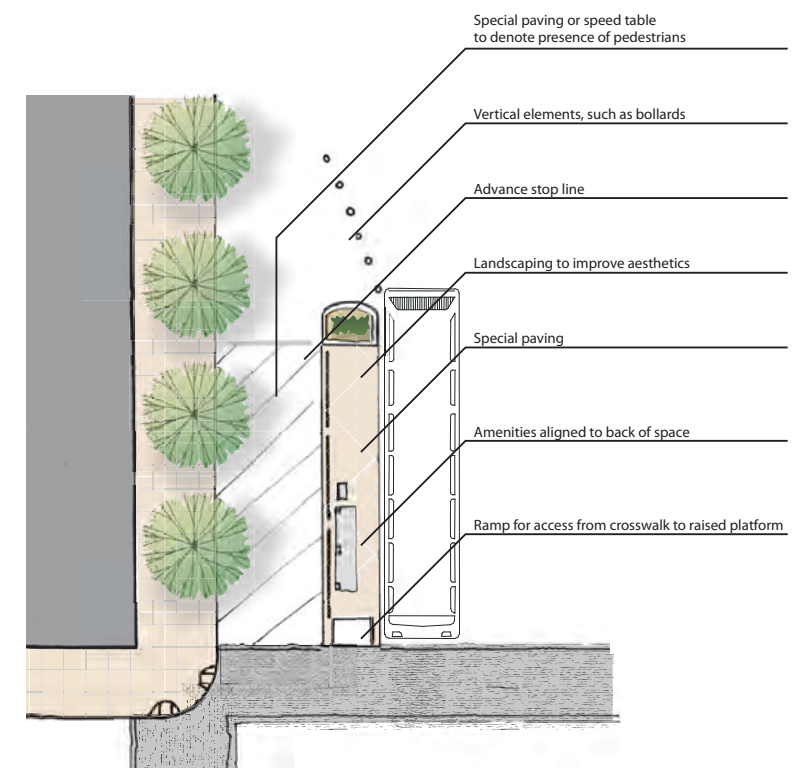
Boarding islands may include low plantings at the back end of transit boarding islands beyond the pedestrian waiting area

### Dimensions

Transit boarding islands should be at least as long as the distance between the front of the vehicle and the rear-most door plus 5 feet. At stops where two or more vehicles are expected to stop simultaneously, the island should be large enough to accommodate all vehicles with 5 feet of space between each pair of stopped vehicles.

Transit boarding islands must include a 5-foot wide by 8-foot long clear loading pad or other accessible facility such as a raised platform with ramp for accessible boarding. Accessible boarding facilities will vary based on the type of vehicle using the stop. The median should be designed so that doors used for accessible boarding align with the boarding area.

#### ▼ Transit boarding island (typical)



### Pedestrian Access

Transit boarding islands should have a crosswalk with curb ramp access at one end, at a minimum, connecting to the sidewalks of the street. The boarding island may serve as a pedestrian refuge for street crossings. In addition, the design of transit boarding islands may employ the following treatments to enhance the design of transit stops, calm traffic in the vehicle lane between the boarding island and sidewalk, and visually connect boarding islands to the sidewalk:

- Provide a raised or high visibility crossing connecting to one end of the platform, on appropriate street types (see Section 4.1)
- Pave the side lane in concrete or other special paving to distinguish it from center lanes
- Create a single-surface zone including the sidewalk, side lane, and boarding island, where traffic speeds and volumes are low. Shared surface treatments should follow the guidelines in Section 5.8.

### ➔ Subway Entrances and Vent Shafts

Subway entrances and vent shafts (where provided) take up significant amounts of sidewalk space and should be designed accordingly. They also provide an opportunity to create distinctive design along major transit and pedestrian corridors. Subway entrances should:

- be located out of the sidewalk area, within buildings (as part of joint development) or in off-sidewalk parks or plazas wherever possible, as long as they are clearly marked;
- where they are located in the sidewalk, they should be placed outside of the path of travel and leave sufficient clear width for accessible travel. In many cases, this may mean adding a curb extension and locating the entrance or vent shaft on the bulb-out;
- include a railing or wall around the opening, high enough to prevent people from falling into the opening, but low enough to see over (3 to 4 feet in height). The wall may be topped with decorative fencing or other visually permeable element;
- include canopies to provide cover from rain; and
- incorporate unique design specific to the particular transit line, giving the corridor as a whole a recognizable design character.

### ADDITIONAL TRANSIT OPERATIONS CONSIDERATIONS

Bulb-outs should be prioritized on transit routes to enhance pedestrian safety and transit operations. At signalized intersections, bulb-outs can extend green time available for transit on the major street by reducing pedestrian crossing times across the major street from side streets.

At transit stops, bulb-outs should be full-length bus bulbs, and not a standard corner bulb, as it can be difficult for a bus to exit or re-enter traffic around a standard corner bulb-out.

Traffic calming devices on bus routes should be compatible with bus operations (see Section 5.7). In particular, strategies involving vertical and horizontal deflection that could affect transit on-time performance and transit user comfort should not be used, particularly on Rapid and Local routes. Effective corner radii should balance the necessity to accommodate transit vehicles with the need for safe pedestrian crossing conditions (see Section 5.2).



Source: Nelson\Nygaard



# Parking Lane Treatments

## 5.6

The parking lane portion of the roadway, typically reserved for parking or loading of vehicles, may play other roles as well to improve the quality and functioning of the pedestrian realm and provide a variety of streetscape and pedestrian amenities, including landscaping, stormwater treatment, bicycle parking, and seating – it represents a significant untapped resource to extend the pedestrian realm.

In addition, on-street parking may provide a buffer for pedestrians on fast-moving, heavily-trafficked streets, by limiting the negative effect of passing traffic on pedestrians.

### GUIDELINES

Narrow right-of-ways without sufficient space for both sidewalks and parking should prioritize the provision of sidewalks to meet recommended sidewalk widths per Section 4.2 of this document. Where parking lanes are not present on busy streets, landscaping, bollards, or other buffering elements should be provided to separate pedestrians and moving vehicles.

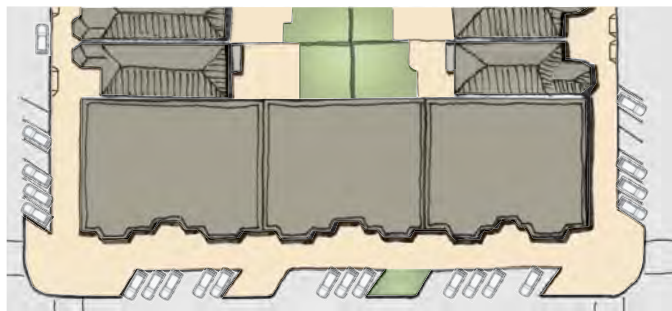
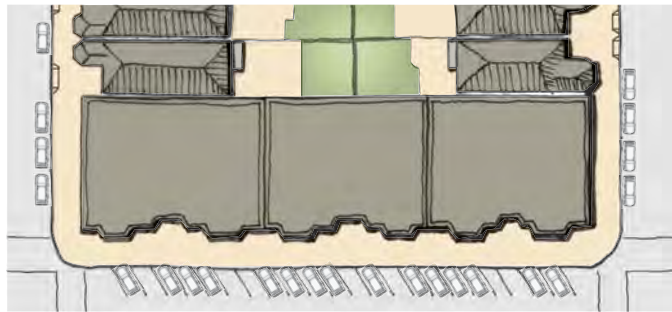
Parking lanes may be configured to provide a variety of streetscape and pedestrian amenities, such as landscaping, stormwater treatment, bicycle parking and seating.







▲ Attractive materials can distinguish the parking lane from other lanes. These pavers could be permeable, helping to reduce stormwater runoff.



▲ Perpendicular or angled parking lanes allow for the creation of generous corner plazas

### Materials

Where it is not precluded by heavy vehicles, the parking lane should be paved in concrete or special paving materials to match the pavement used on the adjacent sidewalk. Permeable paving such as pervious concrete or pavers should be considered for stormwater management per Section 6.2. On new streets, a parking lane that slopes towards the roadway such that the gutter is placed between the two may be considered, particularly in conjunction with curb extensions.

### Plazas at Perpendicular and Angled Parking Lanes

Perpendicular or angled parking lanes may exist or be provided where roadway width allows. They provide additional parking spaces while narrowing the vehicle travelway, which can have a significant traffic calming effect on the street.

Where perpendicular or angled parking is provided, there is an opportunity to create significant public spaces by adding curb extensions adjacent to intersections or mid-block that extend the full length of the parking lane, sometimes up to 20 feet. These generous bulb-outs may include landscaping, seating, and other amenities. Bulb-outs should follow the guidance in Sections 5.2 and 5.3.

Left: Corner bulb-out plaza on a street with perpendicular parking



Right: On-street parking is common throughout San Francisco's urban streets, and defines an edge of the pedestrian realm on many streets.

### ALTERNATIVE USES FOR THE PARKING LANE

Parking lanes can be either temporarily or permanently converted to active pedestrian uses, public seating, café and restaurant seating, and landscaping. Parking lanes may also be used for bicycle parking, per the San Francisco Bicycle Plan.

### Parking Lane Planters

On streets with narrow sidewalks, where tree planting is limited by conflicts with utilities or driveways, or where there is a desire to visually narrow the roadway, landscaped planters may be placed between parking spaces at regular intervals or at specific locations. Because the roadway sub-base is typically 95% compacted, soil improvements should be added to avoid premature tree mortality. See Section 6.1.

Planters should not extend beyond the width of the parking lane; they should be a minimum of 6 feet by 4 feet and meet other guidelines for street trees. Tree canopies should be kept clear of conflict with passing vehicles in the near travel lane; they should be pruned to 14 feet for portions of the tree that overhang the roadway, and meet other guidelines for street trees per Section 6.1.





Typically, parking lane planters should be separated from the sidewalk curb by a minimum 1 foot break; this gap may be covered by a metal grate or trench drain. Alternatively, parking lane planters may be joined with adjacent sidewalk planters to create more generous tree basins with a continuous body of soil.

Trees and planters in the parking lane should be protected from errant drivers by a raised curb, bollard, railing, or other fixed object.

Where in-street planting is designed for stormwater infiltration, the curb may include breaks to allow stormwater to enter and overflow stormwater to exit when the basin is at infiltration capacity. See Section 6.2.

Parking lane planters require special maintenance considerations:

- They present a need for additional hand sweeping of gutter areas between the tree basin curb and the sidewalk curb.
- They may present difficulties with repairing concrete pavement located between the tree basin and the sidewalk.

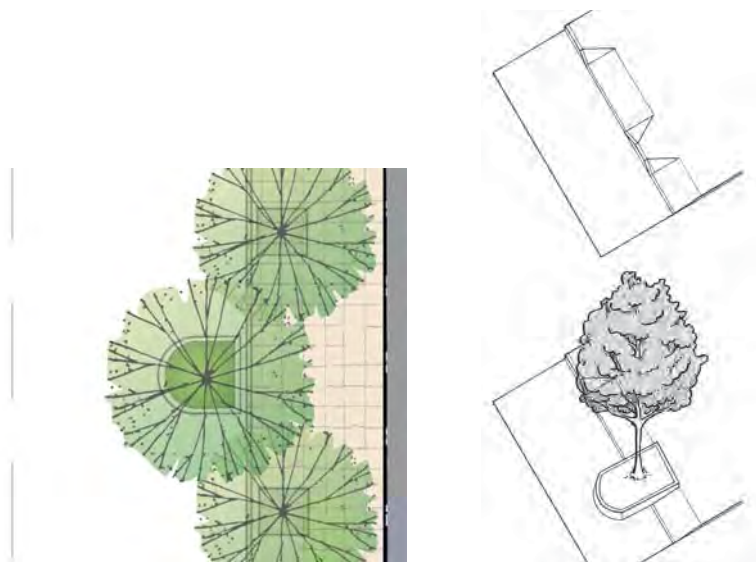
Where parking lane planters are considered, they should be installed with a plan for maintaining the gutter areas and other areas that street sweepers cannot reach.

- ▼ Trees placed in the parking lane can increase space for available greenery and visually narrow the roadway, calming traffic

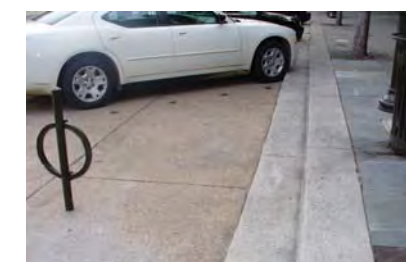
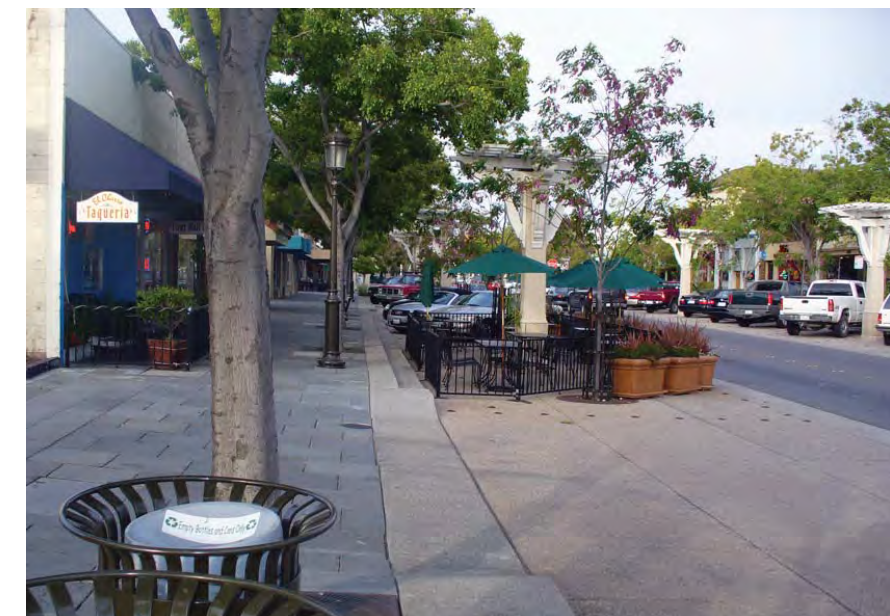
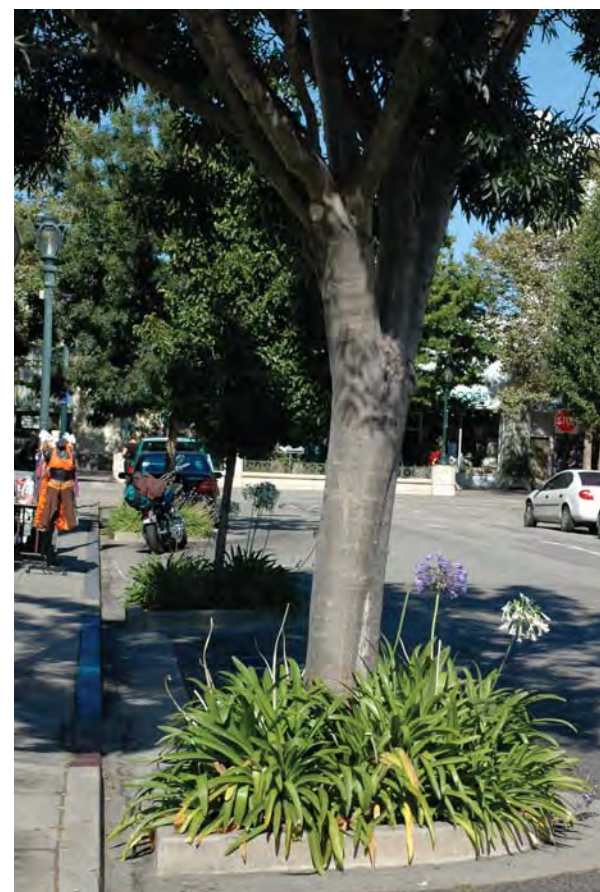
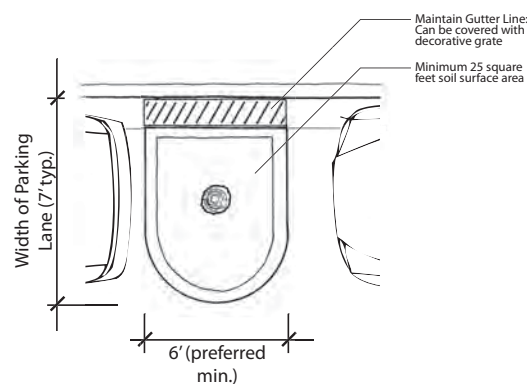
### Flexible Active Use of the Parking Lane

Particularly on active commercial streets, the parking lane may be used for flexible active uses such as café seating on a temporary or semi-permanent basis. Flexible use of parking lanes should be prioritized in commercial areas with high pedestrian volumes or numerous cafes and restaurants, or at individual locations of cafes, schools, libraries and other local destinations. They may also be considered as public spaces on residential streets where property owners agree to maintain any improvements.

Flexible parking may be installed by individual actors, or as part of a full street re-design. This treatment can range along a spectrum from very temporary use to more permanent installations. The City is currently piloting the flexible parking lane concept, and will be developing a permitting process for merchants or property owners.



Landscaped planters in the parking lane



- ▲ Planting and trellises visually narrow the street and define "rooms" within the parking lane
- ◀ A stepped curb provides easier transition for pedestrians



Flexible use of parking lanes generally requires additional parking and merchant management, either by the City or by a third party such as a merchants association, Community Benefit District (CBD), or individual permit holders.

In general, flexible use of the parking lane should take up the full width of the parking lane and at least one full parking space.

Flexible space should be designed to instill a sense that the space is intended for people, rather than that pedestrians or café patrons are temporarily infringing on automobile space. Landscaping, special materials, and elements should be used to visually and physically break the parking lane down into independent, distinct spaces. Both permanent and temporary elements combine to create this space.

Where flexible use of the parking lane will occur as part of a full street re-design, design elements should include:

**Curb Extensions and Permanent Landscaping:**

Landscaped curb extensions or parking lane planters should be located at least every 5 parking spaces (a maximum of 100 feet apart). Vertical elements such as trees, elevated planters, trellises, and other elements should be used to define the visual character of the flexible spaces.

**Special Paving Treatment:** Colored and textured paving materials should be used to differentiate these areas from the roadway. See Section 6.4: Paving.

**Level Change:** A level change of 1 to 2 inches should be introduced between the roadway and the parking lane to differentiate these two areas. The curb between the parking lane and the sidewalk should be designed to include a stepped change in grade, rather than the standard 6” grade change. Flexible space should be made accessible to pedestrians with disabilities by the provision of ramps.

**Safety considerations:** Safety should be strongly considered when placing useable space in the parking lane. Flexible active use of the parking lane should be installed where there is light, slow-moving traffic, narrow roadways, and a pedestrian character.

Buffering elements should be provided for patrons. Moveable planters, bollards, or other elements should be placed at the roadway edge of the parking lane at times when it will be occupied by people. Elements should be relatively transparent, allowing people to see above or around them.

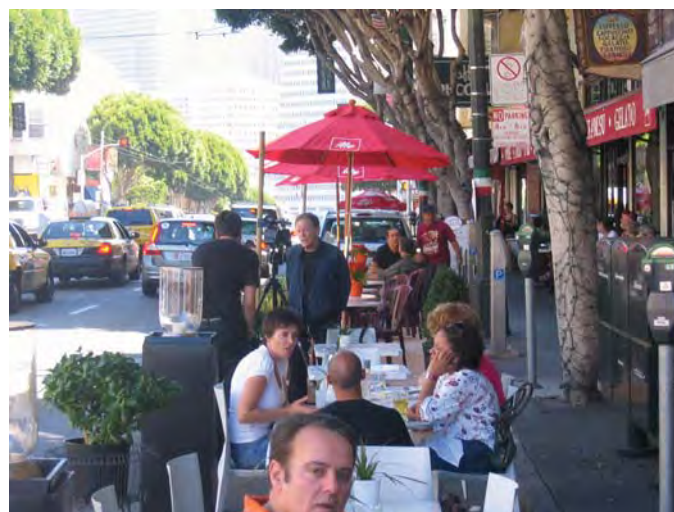
Flexible parking spaces should be placed so they do not conflict with other uses:

- Accessible parking spaces should not be converted to flexible use.
- Flexible uses of parking lanes should not obstruct the safe travel of bicycles in the adjacent bike lane.
- Flexible uses of parking lanes should not obstruct the safe travel of transit vehicles or the ability of passengers to board or alight vehicles.

**Best Practice: Castro Street Flexible Parking**

Mountain View, California

As part of a larger downtown revitalization effort, the City of Mountain View converted a 4-lane arterial into a 3-lane pedestrian-oriented main street. In addition to widening sidewalks and adding unique paving and extensive planters, the City installed flexible parking lanes on either side of the street. These areas use urban design details such as attractive paving and trees and planters on bulbouts to define the shared pedestrian and parking space. Cafes along Castro Street spread tables into the parking stalls in front of their businesses during business hours, allowing patrons to sit under the trees. This project was a major part of bringing business and life back to the town center, and has resulted in a number of cafes with outdoor seating and more people walking on the streets and patronizing local businesses.



◀ Park(ing) Day installations illustrate how the parking lane might be used for public or cafe seating







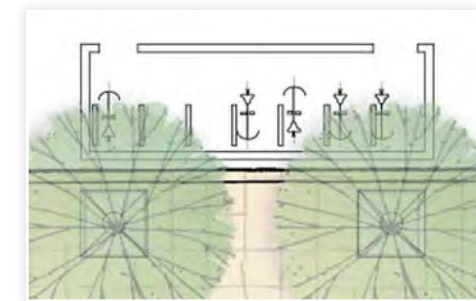
▲ The City's new "Parklet" on Divisadero, part of the Pavement to Parks program

### Bicycle Parking in Parking Lanes

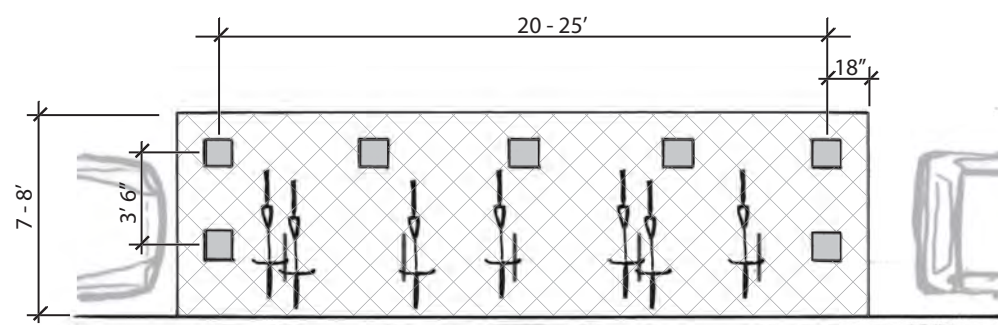
Per the San Francisco Bicycle Plan, on-street vehicle parking spaces may be converted to bicycle parking. Bicycle parking may also be provided in the parking lane where there is not enough room to park a car, such as between driveways.

Bike racks should be placed such that parked bikes are perpendicular to the curb line. One 20 foot parking space can accommodate up to 12 bicycles on 6 U-racks without cluttering limited sidewalk space.

Where possible, bicycle parking should be built on a curb extension. Where implemented at the existing grade, the bike parking area should be protected from errant vehicles via a curb, bollards or other devices at the edge of the parking lane. On-street bicycle parking would preclude mechanical street sweeping, and additional maintenance should be accounted for.



Per the San Francisco Bicycle Plan, on-street spaces can be converted into bicycle parking areas to provide substantially more bicycle parking and reduce sidewalk congestion.



▲ Layout of an on-street bicycle parking space (typical). On-street bicycle parking should be designed with racks perpendicular to the curb, and elements to protect bicycles and racks from errant drivers.

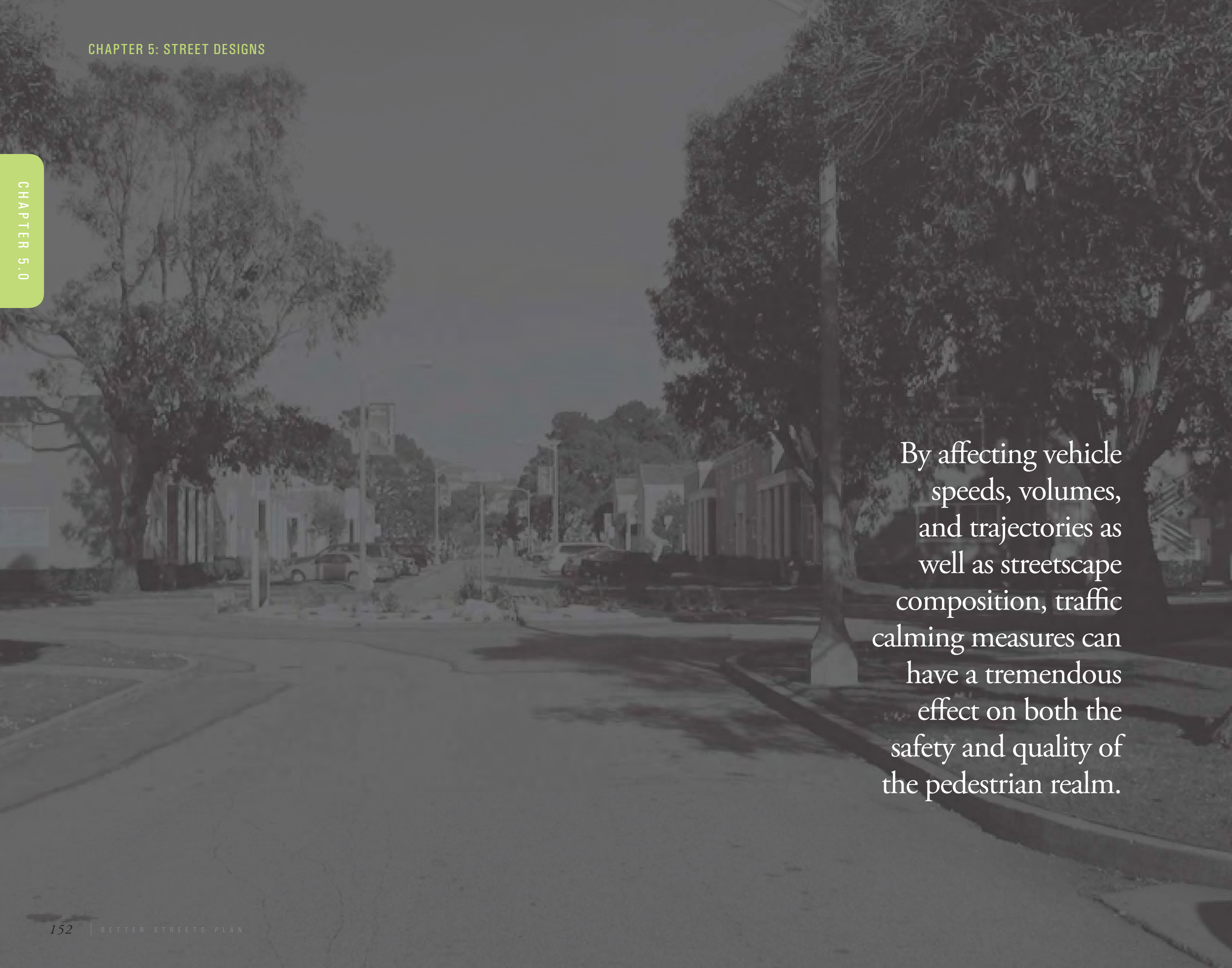
### ➔ Bike Share Parking



San Francisco is considering implementing a bicycle sharing program similar to programs in Paris, Lyon and Barcelona. If San Francisco implements bicycle-sharing, conversion of some automobile parking spaces to bicycle parking could help accommodate the storage racks which hold as many as 20 to 30 bicycles so as not to block space on the sidewalk for pedestrian travel.

▲ Paris and Lyon are among the cities that have implemented bicycle-sharing programs. To provide the necessary space for the many new bicycles, on-street parking space may be covered for use as bicycle parking. Source: Elizabeth Macdonald





By affecting vehicle speeds, volumes, and trajectories as well as streetscape composition, traffic calming measures can have a tremendous effect on both the safety and quality of the pedestrian realm.



# Traffic Calming and Roundabouts

## 5.7

By slowing traffic and discouraging cut-throughs, traffic calming measures can have a tremendous effect on the safety and quality of the pedestrian realm. Many traffic calming features can also contribute to the aesthetic quality of the streetscape. There are a wide variety of traffic calming devices available to street designers, which are covered fully in many other documents. The intent of this document is not to discuss all potential traffic calming devices.

This section focuses on chicanes, traffic calming circles, and modern roundabouts as representative traffic calming devices, because of their potential synergies with streetscape design, landscaping, and stormwater treatment, and because unlike diverters, turn restrictions, cul-de-sacs, one-way streets, or other measures, they reclaim roadway space

for landscaping and other uses without significantly affecting traffic patterns and roadway vehicle capacity, which would go beyond the scope of this plan.

Some related traffic calming measures are discussed in other sections of this document, including:

- raised crosswalks and intersections (Section 5.1);
- curb extensions (5.3); and
- medians and islands (5.4).

The City has existing adopted Traffic Calming Guidelines, which govern appropriate traffic calming procedures and measures (see sidebar).



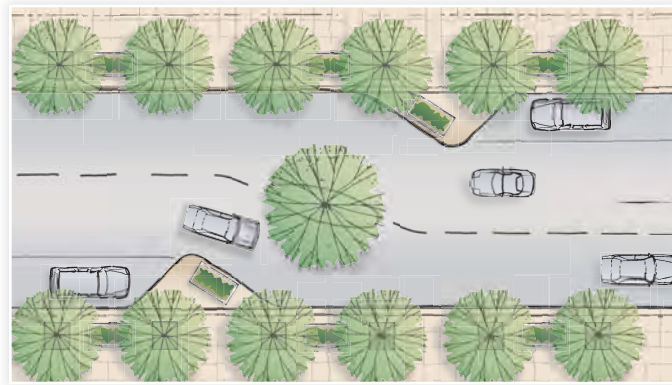


### General Guidelines

Traffic calming features should follow San Francisco’s existing Traffic Calming Guidelines. Features discussed in this plan should incorporate landscaping, stormwater treatment, and public space uses wherever possible.

Traffic calming features should be compatible with transit operations. See Section 5.5.

Traffic calming features could slow the movement or affect access for emergency vehicles, if not designed accordingly. Traffic calming features should be designed to retain emergency vehicle access, per guidelines below. See Sidebar, “Traffic Calming and Emergency Access,” following page.



▲ Chicane with parking alternating from side to side

### CHICANES

A chicane is a series of alternating mid-block curb extensions or islands that narrow the roadway and require vehicles to follow a curving, S-shaped path, discouraging speeding. Chicanes can also create new areas for landscaping and public space in the roadway.

#### Guidelines

Chicanes can be created on roads with various roadway configurations, as follows:

- On streets with space for parking on only one side, chicanes can be created by alternating parking from side to side. Chicanes can also be formed by alternating parallel parking and perpendicular parking. Curb extensions should be included at each end of on-street parking.
- Where a wide right-of-way allows, parking may be maintained on both sides of the street through the entire chicane, and the entire roadway can jog from side to side using curb extensions.

Chicanes in both conditions may include a median island at points of deflection to prevent speeding drivers from continuing straight down the center of the chicane, disregarding roadway markings.

#### San Francisco’s Traffic Calming Guidelines

San Francisco’s existing Traffic Calming Guidelines were developed collaboratively by a staff Technical Working Group and a Community Working Group. The Traffic Calming Guidelines are largely procedural, and are based upon a three-track approach:

- A track for arterial and commercial streets, using a corridor approach
- A local street track with an area-wide focus and a local street track with a site specific focus, with a streamlined process
- A site-specific track for safe routes to school

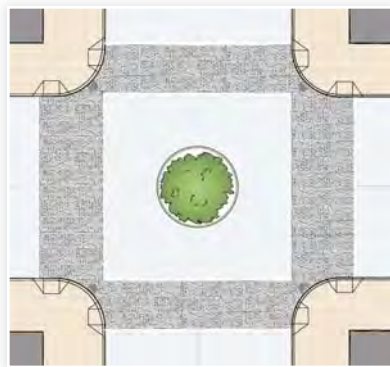
The Traffic Calming Guidelines provide a table of traffic calming measures that indicates which measures are acceptable on which types of San Francisco streets. However, they do not provide standard plans or detailed design guidelines for individual measures.

The City has standard plans for traffic circles and speed humps, and is developing standard plans for other traffic calming measures.



▲ Chicanes slow vehicles by causing them to shift their horizontal path. They add opportunities for landscaping to improve street aesthetics. Source: Mike King





Traffic circles slow traffic in residential neighborhoods and provide added space for landscaping and stormwater infiltration.

- ▼ Traffic circles should include landscaping, including trees, and permeable surface. They may be designed to infiltrate stormwater runoff from the roadway.



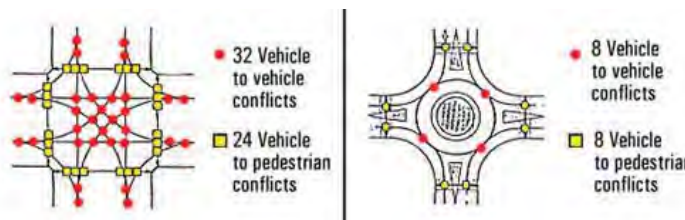
Median islands and curb extensions (in chicanes as elsewhere) should include landscaping, seating, and stormwater facilities per the guidelines for these facilities in Chapter 6.

Because chicanes are intended to slow traffic, designs should consider transit and emergency vehicles:

- Chicanes should not be located on streets with Rapid or Local lines per Muni's operating framework. Though discouraged, chicanes may be implemented on streets with Community lines only; in these cases, the chicane should be located at a bus stop so that the impact on transit service and passenger comfort is minimized.
- Chicanes must maintain required clearances for emergency vehicle access, 14 feet on a one-way street and 20 feet on a two-way street. Among traffic calming measures, emergency vehicle operators typically prefer chicanes to speed humps, but the Fire Department has not expressed a formal preference.

Chicanes should be designed to force vehicles to slow as they change course. Standard CA MUTCD formulas for calculating taper lengths for striping around a horizontal offset caused by obstacles in the roadway typically yield tapers too long to achieve the desired slowing of vehicles. Accordingly, chicanes should be designed using formulas for lower speeds than are actually desired on the street.

- ▼ Conflict points at traffic calming circles (and roundabouts).



Source: Stidger, Ruth "Can America Handle Roundabouts," *Better Roads*, May 2003

## TRAFFIC CALMING CIRCLES

A traffic calming circle is a raised island located in the center of an intersection around which traffic must circulate. By providing a landscaped area in the middle of the roadway, they can visually break up the scale of wide streets, break up the monotony of the street grid, and provide space for added greenery and stormwater treatment. The outer ring is often mountable so that large vehicles can navigate the otherwise small curb radius. Traffic calming circles are generally used at low volume neighborhood intersections.

If not properly designed or located, traffic calming circles may create confusion or inconvenience for people with visual impairments; care should be taken to minimize confusion and conflicts with their design.

Traffic calming circles should not be confused with roundabouts, which are designed to handle much higher traffic volumes and reduce vehicle delay (see following section). However, they have a similar positive effect of significantly reducing conflicts (see graphic).

### Placement

Traffic circles should be located on streets where it is desirable to calm traffic and reduce conflicts, such as residential streets. Traffic circles should not be located on transit routes.

### Guidelines

Traffic circle design should follow DPW Bureau of Engineering's standard plan for Traffic Circle Details. However, intersection geometry varies greatly, and the standard plan may need to be adjusted for different conditions.

Traffic calming circles should be large enough that vehicles entering the intersection must slow down and change course, but they should not significantly alter the path of travel for pedestrians or bicyclists. The size of traffic calming circles is determined based on the width of the adjoining streets. The installation of traffic calming circles does not usually require a change in curb geometry.

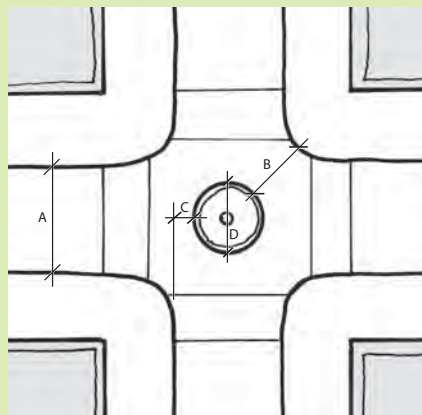
**➔ Best Practice:  
Seattle, Washington Traffic Circles**

The City of Seattle has installed over 700 traffic circles on residential streets as part of a citywide plan to reduce auto volumes and speeds in residential areas. The City receives approximately 700 requests for new circles each year, and installs 30 per year at a typical cost of about \$10,000 each.

Seattle’s traffic circles are large enough to force cars to slow down to go around them. The center islands are attractively landscaped. The outer two feet or so of the circles is a concrete apron, with a low four-inch curb that emergency vehicles can go over easily when necessary. Typical traffic circles on a 25 foot wide residential street range between 12 and 16 feet wide.

The circles typically include 1 or 3 trees. Additionally, neighborhood residents can plant lower brushes and shrubs in the circles. The City encourages planting of low-maintenance plants and publishes a list of suggested trees and planting for traffic circles. Landscaping in the traffic circles is maintained by local residents.

Source: City of Seattle, Seattle Transportation (SEATLAN)



A - Street Width: Existing  
B - Opening Width: Typically 16-20 feet  
C - Offset Distance: 5.5 feet max. (varies)  
D - Diameter: Typically 12-20 feet

OPTIMAL DIMENSIONS	
Offset Distance	Opening Width
5.5' (max)	16' (min)
5.0'	17' (+/-)
4.5'	18' (+/-)
4.0'	19' (+/-)
3.5' or less	20' (+/-)

**➔ Design Dimensions (Seattle)**

The distance between a traffic circle and the curb (off-set distance) should be a maximum of 5-1/2 feet.

The width between a traffic circle and a curb return (opening width) should be a minimum of 16 feet and a maximum of 20 feet.

As the off-set distance decreases from the maximum 5 ½ feet, the opening width should increase from the minimum of 16 feet according to the table below.

The outside 2 feet of the traffic circle should be constructed with a mountable monolithic cement concrete curb and pavement surface doweled to the existing pavement.

**➔ Traffic Calming and Emergency Access**

Emergency vehicle access is often a determining factor in street design and traffic calming projects. Emergency access standards can impact a number of design features recommended in this plan.

Emergency service providers may be concerned about traffic calming features, such as chicanes, traffic circles, or speed humps that may slow emergency response time.

On most streets sufficient width exists as a matter of course. However, some treatments discussed in this plan may conflict with minimum width or response time requirements, including traffic circles, chicanes, medians and islands, shared public ways, and local lanes of multi-way boulevards.

In some cases, design techniques may be employed to mitigate impacts on emergency access, for example, by providing mountable curbs or aprons at the edges of traffic circles or medians. In other cases, proposed design features may not work at all, and may have to be eliminated from proposals.

Achieving good street design that meets traffic calming and pedestrian safety and comfort objectives while maintaining necessary emergency access requires further discussion between agencies that design and build streets and emergency service providers. The City should create a forum to focus on this issue.



Traffic calming circles should maintain sufficient space such that vehicles do not swing into crosswalks. In properly designed circles, vehicles navigating the intersection will not intrude into the pedestrian crossing area. A minimum of 11' of clearance between the circle edge and the crossing location should be used per standard plans.

This may mean setting crosswalks back such that they align with the inside edge of the furnishing zone instead of the curb. However, they should retain a linear path of travel from the throughway zone directly to the curb ramp and the crosswalk. Where it is not possible to do this, alternative traffic calming measures should be used.

Traffic calming circles should include signage to indicate the direction of circulation.

Traffic calming circles should be designed with a vertical inner curb and a mountable apron per standard plans. The vertical inner curb prevents vehicles from driving over the circle. The apron is a shallow sloped curb extending out from the bottom of a vertical curb, with a low lip at its pavement-side edge. This apron allows large vehicles to make turns, while slowing other vehicles.

Traffic calming “circles” need not be circular. Other shapes may be used to slow traffic in one direction more than others, for example where a busy street intersects with a residential area.

Traffic calming circles should be landscaped with trees or plantings. Shrubs and grasses should be planted up to 3 feet tall and trees should follow the branching height and pruning guidelines described in Section 6.1.

Trees should be planted a minimum of 4 feet from the inside edge of the curb. In traffic calming circles with a diameter of less than 15 feet, one tree should be planted in the center. On a traffic calming circle with a diameter greater than 15 feet, more than 1 tree should be planted and should be equally spaced around the circle.

Traffic calming circles added by neighborhood request should consider added maintenance burdens; this may require maintenance agreements with adjacent property owners.

Utilities may remain within traffic calming circles.

## MODERN ROUNDABOUTS

Roundabouts may be used at large intersections in place of signals and can handle significant traffic volumes. Although their primary purpose is to improve traffic flow, properly designed roundabouts can create a positive pedestrian environment and a unique design opportunity.

Roundabouts have lower vehicle speeds and fewer pedestrian collisions than standard signalized or unsignalized intersections, and experience has demonstrated that vehicular crashes are significantly reduced when low-speed, single lane roundabouts replace four-way intersections.

When vehicular volumes are low to moderate, roundabouts allow pedestrians to cross frequently without waiting for vehicles to stop. However, crossing pedestrians are not protected since vehicles are free flowing. Modern roundabouts incorporate splitter islands to provide crossing refuge for pedestrians and deflect the path of motor vehicles. This deflection reduces vehicle speeds making it easier for pedestrians to cross. Because they introduce non-standard geometry to the intersection, roundabouts can be confusing to pedestrians with visual impairments and special care should be taken to provide wayfinding cues (see sidebar).

### ➔ Roundabouts & Pedestrian Wayfinding

Modern roundabouts present challenges for pedestrians with visual impairments because vehicles are not required to stop at an intersection with a roundabout as at a conventional intersection. Visibility of crosswalks and detectable entry points of crosswalks should therefore be carefully considered and should be addressed through appropriate signage and higher visibility crosswalk treatments. Signage indicating the presence of the pedestrian crossing should be used to remind drivers that while they are only required to yield to traffic within the roundabout, they are required to stop for pedestrians that are in the crosswalk.

Wayfinding and gap selection cues should be incorporated into the design of roundabouts so they do not become a barrier to pedestrians with visual impairments. Detectable warning strips should be used at all pedestrian crossing entry points. Sidewalks should be set back from the edge of the circulatory roadway by at least 5 feet so that pedestrians with visual impairments can clearly follow designated crossing points. This also serves to discourage pedestrians from crossing to the center island and provides space for landscaping.

Research into how better design roundabouts for pedestrians with visual impairments is currently underway by the National Cooperative Highway Research Program (NCHRP) and should be incorporated into designs when its findings are released.



▲ Roundabouts are typically larger, higher traffic volume intersections than traffic circles. The larger center island and multiple medians provide ample opportunity for planting and stormwater management.

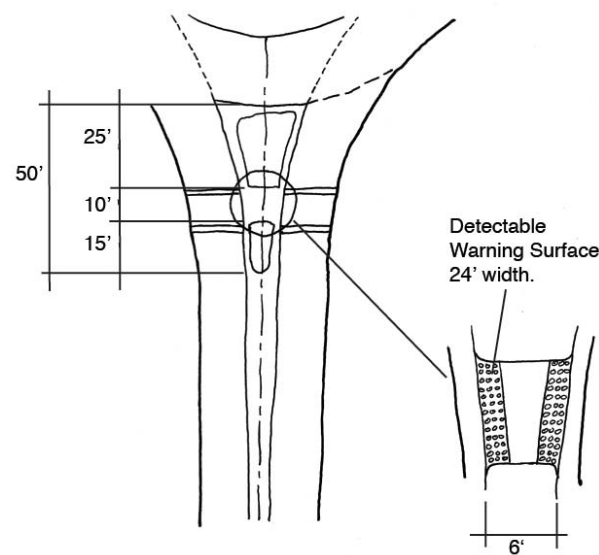
### Placement

Roundabouts have limited applicability in San Francisco due to their scale and complexity.

Roundabouts are appropriate at medium to high volume intersections that would otherwise have some other form of intersection control, such as a four-way stop or traffic signal. Modern roundabouts may be considered under the following conditions:

- intersections with more than four intersecting streets;
- high volume grade-separated intersections where there is a desire to bring streets back to surface level to create at-grade intersections; and
- intersections with freeway on and off ramps.

Many typical San Francisco site-specific conditions may preclude installation of a roundabout, including: physical and geometric constraints; heavy pedestrian and bicycle movements; proximity of other traffic control devices that would require preemption (e.g. railroad tracks or Rapid transit routes); or high numbers of oversized trucks.

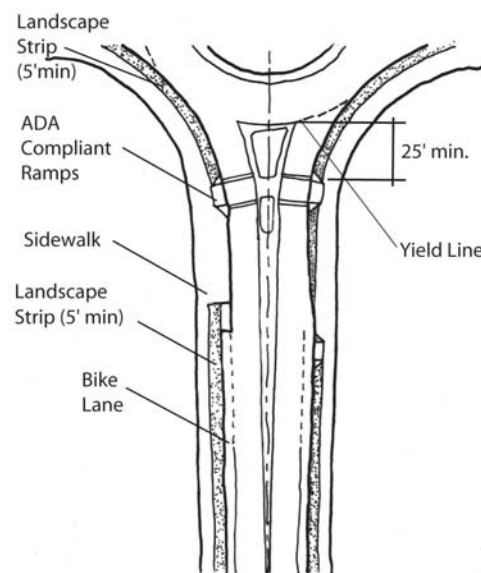


Where roundabouts are feasible and desirable, their use may be considered pursuant to additional study and environmental review. Where roundabouts are used, they should follow the pedestrian design guidelines in this section.

### Guidelines

Crossings at intersections with modern roundabouts should minimize pedestrian exposure to vehicles, using the following techniques:

- Crossing distances should be minimized.
- Unobstructed sight distance between crosswalks and approaching traffic should be provided.
- At single lane roundabouts, the pedestrian crossing should be at least one vehicle length (25 feet) from the yield line at the intersection with the roundabout to allow one car to queue beyond the crossing.
- At double lane roundabouts, the crossing should be at least two vehicle lengths (50 feet) from the yield line.
- Splitter islands should be provided. Pedestrian refuges should meet the guidelines in Section 5.4.



#### NOTE:

In general, roundabouts have limited application in San Francisco due to the typical constrained conditions at many intersections and on-going debate as to their appropriateness for pedestrian-oriented environments. At some larger intersections with unusual traffic alignments and high traffic volumes they may be considered to improve capacity and roadway function. This section is intended to address safe and attractive design of roundabouts for pedestrians, cyclists, and transit users, where it is determined that a roundabout is to be implemented. It does not focus on transportation and traffic management functions, though these are alluded to in explanation of roundabout function. For additional detail on traffic engineering and design considerations, see *Roundabouts: An Informational Guide*, published by the Federal Highway Administration.

Roundabouts should be landscaped. Plantings should be less than 3- feet tall within 4 feet of the edge of the curb

Roundabouts may be considered for distinctive landscape treatments or public art installations such as fountains to create a gateway to major civic locations or to the City from highways. Where space allows, useable public space may be designed within the center island.

### Transit Stops

Transit stops located on the near side of the roundabout should be located far enough away from the splitter island so that a vehicle overtaking a bus would not be forced into the island. For a single lane entry where capacity is not an issue the transit stop can be located at the crosswalk. Transit stops on the far-side of the roundabout should be located beyond the pedestrian crossing and have pull-outs constructed to minimize queuing in the roundabout.

### Bike Facilities

Bicyclists may be disadvantaged by roundabout design, and marked bicycle lanes through roundabouts have not been shown to improve safety. Bike lanes should terminate in advance of crosswalks at roundabouts. For one-lane roundabouts with slow speeds and light traffic, bicyclists may merge into the vehicular travel lane comfortably. At multi-lane roundabouts, which are more challenging for cyclists to navigate, additional safety and design features should be provided.

▲ Crossings at roundabouts should have splitter islands and be set back from the intersection



# Pedestrian-Priority Designs

## 5.8

### POCKET PARKS

Pocket parks are small, active public spaces created in the existing public right-of-way. They can be located in medians, curb extensions, or in the furnishings zone on sufficiently wide sidewalks. In addition to landscaping, pocket parks may include seating areas, play areas, community garden space, or other elements to encourage active use of the public open space. Pocket parks provide important public space in areas with high-density land use and areas deficient in open space.

#### Guidelines

Pocket parks should provide a variety of open space functions including active and social activities, in addition to ornamental functions. Pocket parks may include seating, café tables, play or fitness equipment, open lawn space, dog runs, community gardens, ecological/educational displays, and community bulletin boards.

Pocket parks should be landscaped or use special paving materials to differentiate their unique open space function from the normal sidewalk or median.

A landscaped or constructed edge should be included at the edge of the pocket park to create a buffer from passing traffic. The buffer may be landscaped, such as a hedge, or constructed, such as bollards, a low fence, or a low wall (with integrated seating). The buffer should generally not be higher than 30 inches.

Pocket parks may be designed to serve as stormwater retention and infiltration areas. Pocket parks should be terraced along steep streets to maintain ADA access and provide seating areas.





### Sidewalk Pocket Parks

Sidewalk pocket parks should be a minimum of 15 feet long and ideally at least 20 feet wide. Specific dimensions should be determined based on the width of the public right-of-way, space between driveways, and the needs of the surrounding neighborhood.

Where on-street parking is provided, a 2 foot minimum vehicle egress area (courtesy strip), and a 4 foot walkable pathway or other accessible route should be provided at each parking space to allow access from parked cars to the sidewalk per Section 4.2.

### Median Pocket Parks

Median pocket parks should connect to the primary pedestrian network through marked crossings at each end and, on long blocks, at a mid-block crossing. Bollards should be provided at the ends of the median to define the edges of the park space and create a formalized, special entrance.

Median pocket parks should extend the full length of the block or as long as space allows.

Median pocket parks should be a minimum of 12 feet wide and 24 feet long, including:

- an accessible pedestrian path, 4 feet or wider, connected to intersection and mid-block crossings;
- a minimum 18 inches of buffer on each side of the median such as landscaping or bollards; and
- a minimum of 5 feet of seating, planting or other amenities.

Median pocket parks should exceed these minimum guidelines as width allows for the setting and intended use of the space. A more flexible approach to the edge of the median can be taken on streets with low traffic volumes and speeds, where a lesser buffer may be necessary. In these cases, special design and paving treatments may be continued through the roadway to emphasize the pedestrian-oriented nature of the space.



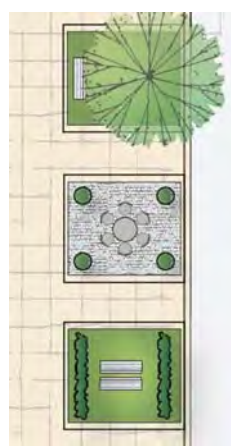
### ➔ Reuse of “Pork Chops” and Excess Right-of-Way

In many locations, historic development patterns and the intersection of street grids result in excessive but unusable pavement spaces (called “pork chops” to describe a common shape). Similarly, many city streets are designed for more traffic than actually uses them. These excess paved areas provide many opportunities for pedestrian improvements, landscaping, and active public space.

Pork chops and unused intersection spaces should be brought to sidewalk level and should include landscaping, seating, and active uses. These spaces can be used to create bosques, rain gardens, paving treatments, public art, and other creative designs.

Each case is unique, but even small spaces can be effectively used for local improvements:

- 25 square feet can be enough for healthy tree planting; even less is necessary for corner landscaping.
- A few feet of roadway width along a street can provide space for a swale or landscaped strip.
- A 7 foot corner or mid-block curb extension can provide space for seating areas (see Section 5.3).



◀ Pocket parks can be created in both medians and sufficiently wide sidewalks





➔ **Best Practice: Sandy Boulevard Corner Triangles**

Portland, Oregon

Similar to San Francisco, Portland has a grid-based street system with some streets that break the pattern resulting in small spaces at odd corners. On one such street, Sandy Boulevard, these triangular spaces were previously paved as part of the roadway, resulting in crossings of over 100 feet. To improve this situation, the City of Portland extended the curbs to narrow crossings, and constructed stormwater gardens, public parks, and cafes in the resulting open space.



Courtesy City of Portland's Department of Transportation and Bureau of Environmental Services. Design by Nevue Ngan Associates, URS Engineering, and Lloyd Lindley, FASLA.

- ◀ 1. The Duboce Triangle neighborhood includes a number of small sidewalk pocket parks.
- 2. This median includes a pedestrian and multi-use path lined with substantial landscape buffers where people can sit and relax. *Source: Mike King*
- 3. San Francisco's South Park is a median pocket park that includes benches, green space, and a children's play area.

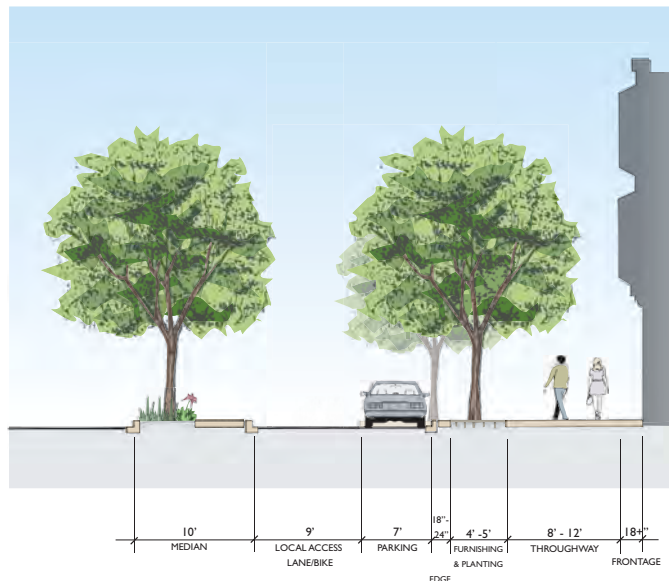


## PEDESTRIAN DESIGN FOR BOULEVARDS

Multi-way boulevards, such as Octavia Boulevard, are designed to separate through traffic from traffic accessing local uses. Many existing San Francisco streets may be appropriate for conversion to boulevards. Boulevards can improve the experience of the street for all users. Benefits of boulevards include:

- Local access lanes make travel safer and easier for through traffic and local traffic by separating these two functions.
- Local access lanes can be used as a shared space for local uses such as deliveries, calm residential streets for children to bike on, calm, pedestrian-priority streets, and space for local businesses to temporarily use for special events with a street closure.
- Multiple medians create the opportunity to add design features such as multiple rows of trees, special paving areas, and various areas for walking or sitting.

A multi-way boulevard has local access lanes on each side of the street. A one-side boulevard involves the installation of a local access lane on only one side of the street, where there is a constrained right-of-way or a different land use context on each side of the street.



Boulevard treatment should be considered for streets that serve both local traffic and significant through traffic and have sufficient right-of-way (generally more than 100 feet, though a minimum width could be as low as 86 feet).

### Definitions

**Multi-way boulevard:** Street type that separates through traffic from local access through the use of medians

**Community Space:** Portion of a multi-way boulevard that includes side medians, local access lanes, parking, and sidewalks

**Local access lanes:** also “Side access lanes” or “Side lanes”. Vehicle and bicycle lanes on a multi-way boulevard that serve parking, loading, and adjacent land uses, separated by a median from through traffic

**Through lanes:** Vehicle and bicycle lanes separated from local uses and parking by a median

**Center median:** Median separating opposing directions of vehicle travel on through lanes

**Side median:** Median separating through lanes from local access lanes

### Guidelines

Boulevards should clearly demarcate local community space from through traffic. Community space should feature pedestrian and bicycle scale design.

Medians should establish a boundary between through traffic and the neighborhood-oriented space. The preferred width for side medians is 10 feet, including 6 feet for landscaping and street trees, and 4 feet of walkable surface, even if the median is not intended for active use. In order to provide the required 14 feet of emergency access clearance in the side lanes, a mountable curb may be provided and the clear walkable surface included in the emergency access width.







- ▲ Side medians and local access lanes, such as those on Octavia Boulevard, should be designed as pedestrian space that serves adjacent neighborhoods and businesses.

### ➔ Best Practice: Octavia Boulevard

San Francisco, California

Octavia Boulevard is the focal element of a larger neighborhood revitalization project in San Francisco's Hayes Valley district.

The design of Octavia Boulevard was the result of extensive stakeholder outreach, design charrettes, and collaboration among City agencies. The street is San Francisco's first modern multi-way boulevard, separating through traffic from local access. It includes an ample pedestrian realm, active recreational areas, and substantial green space in a right-of-way that was formerly an elevated freeway. At one end, the boulevard culminates in Patricia's Green, a new open space for the Hayes Valley neighborhood.

The design of Octavia Boulevard is a mixed success. Many design elements including the multiple rows of trees are attractive and effective, and the street has proven able to successfully carry through traffic and allow local access in a pedestrian-oriented environment. To accommodate emergency vehicles and parking and driveway access, side access lanes were built too wide to effectively discourage through traffic from speeding down them. These lanes feel like any other street, rather than shared space meant for local and neighborhood use, and speed humps have been added retroactively. Narrower lanes, special paving, raised crossings, and curb extensions would more effectively discourage through traffic and slow traffic that does pass through, allowing local residents to confidently venture out into this space and use it and the side medians.

Community space in boulevards should include the following elements:

- ➔ Street trees, pedestrian lighting, and site furnishings in the side medians
- ➔ A slight grade change (at least 1 to 2 inches) from the local access lane to the median and sidewalk
- ➔ Special paving in the roadway of local lanes (see Section 6.4)
- ➔ Raised crosswalks at intersections between the sidewalk and side medians (5.1)
- ➔ Curb extensions (5.3)

The community space on a multi-way boulevard may also be designed as a Shared public way, with the entire shared space at sidewalk grade. Shared space in boulevards should follow the guidelines for shared public ways in the following section.

Parking may be located on either the median or the sidewalk side of the local access lane and can be parallel parking or angle parking.

There are two alternatives for intersection design on multi-way boulevards:

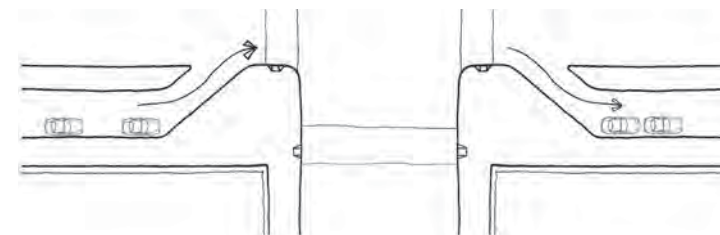
- ➔ **Alternative 1:** Bring local access lanes back to through lanes in advance of the intersection to provide a large corner bulb-out with space for seating, landscaping and other amenities. This discourages through travel in the side access lanes.
- ➔ **Alternative 2:** Extend the side median directly to the intersection to create a pedestrian refuge island with a thumbnail at the intersection end. This allows continuous traffic flow in both the through traffic lane and in the side access lanes.

- ▶ Parking on the median side of the local access lane can improve connections between the sidewalk and the local lane, making the side access lanes act as part of the pedestrian realm.

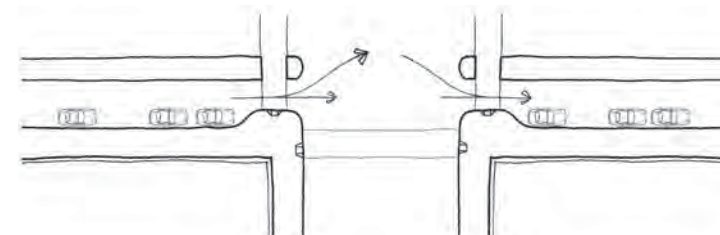
### *Transit Stops at Boulevards*

On streets with transit, transit vehicles can be accommodated in the right-most through lane by placing the transit stop and amenities on the side median. Transit vehicles can also operate in the local access lane if a wide enough travel lane is provided. However, this may result in slower transit performance and increased traffic in the local access lane, which can negate the function of this area as community space.

Alternative 1



Alternative 2





## SHARED PUBLIC WAYS

Shared public ways are public right-of-ways designed for pedestrian use which permit vehicles and bicycles to share the open space. Shared public ways:

- prioritize use of the entire right-of-way for pedestrians and public space over vehicular through travel;
- accommodate small numbers of vehicles at low speeds as necessary for local access to building entries and driveways, on-street parking, loading, service and emergency access, and deliveries; and
- provide clarity for people with visual impairments regarding the shared pedestrian/vehicular nature of the space.

The character of a shared public way may vary, from quiet, residential-only lanes to mixed-use residential and pedestrian-oriented commercial streets with or without transit.

Shared public ways may be designed with special paving, a variety of amenities, landscaping, and seating, and pockets of on-street parking, to create a safe environment that encourages public recreational use and socialization. They are especially valuable, and should be prioritized, in neighborhoods with limited opportunities for public open space.

Shared public ways may be considered on streets that:

- do not have parking garages with greater than 100 parking spaces;
- have through traffic of fewer than 100 cars per hour; and
- do not have transit service.

On streets that do not meet all of these criteria, Shared public ways may still be appropriate pursuant to additional study and environmental review.

### Definitions

**Detectable warning:** An approved standardized surface or feature built into or applied to walking surfaces or other elements to warn visually impaired persons of hazards in the path of travel

**Gateway:** A constrained vehicular entry into the shared public way, composed of physical elements that provide visual and physical cues to vehicle drivers that they are entering a shared public way



Photo: Ellen Vanderslice, Portland Office of Transportation

- ▲ Single-surface treatments create unique opportunities for special pedestrian-scale design and amenities, added landscaping, and special spaces within the right-of-way.



Photo: Ellen Vanderslice, Portland Office of Transportation

◀ Chinatown Festival Street, Portland, OR.





▲ Special paving treatments, landscaping, and other elements can be used to delineate spaces within the right-of-way

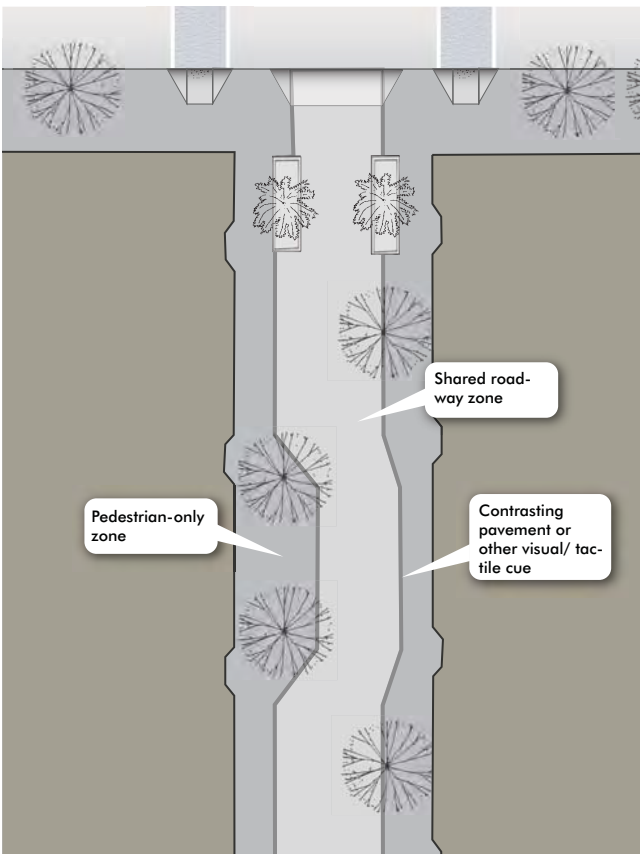
**Hazardous vehicular area:** A public right-of-way, vehicular street, or alley with a 15 mile per hour or greater speed limit

**Pedestrian-only zone:** the portion of the shared public way dedicated to pedestrian use (except where driveways cross over)

**Shared zone:** the portion of the shared public way that is utilized by pedestrians, bicyclists and vehicles

**Shared public way:** public right-of-ways designed for pedestrian use, and which also permits low volumes and speeds of vehicles and bicycles to share the open space. By definition and through design criteria, shared public ways are not hazardous vehicular areas.

**Transit mall:** a shared public way that includes transit vehicles



▲ Shared public ways greater than 15' in width should distinguish between pedestrian-only and shared zones through contrasting paving or other measures

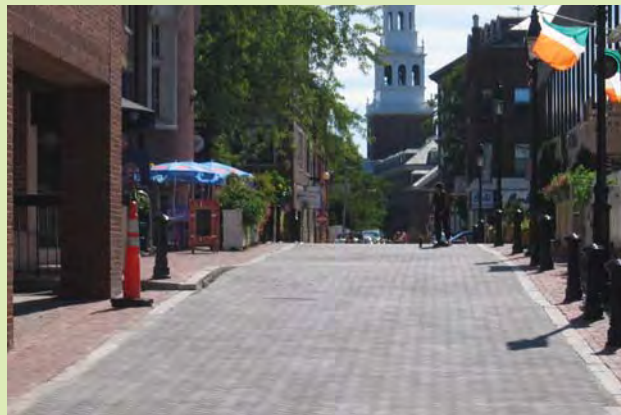
### ➔ Best Practice: Shared Streets

Cambridge, Massachusetts

Over the last 5 years, Cambridge, Massachusetts has had a 12 member design committee working with City staff to plan streetscape improvements around Harvard Square. It had been over 20 years since any urban design projects were constructed, and when it came time to repair some crumbling sidewalks the community saw it as an opportunity to overhaul the area due to its high volume of pedestrian traffic and importance in public life.

Improvements to date include aesthetic and safety-related projects including attractive lighting and landscaping, widened sidewalks, improved signal timing and crossing conditions at

intersections, curb extensions, bike parking and bike route improvements, and construction of a number of shared streets. In many cases, high pedestrian volumes and ADA access could not be appropriately accommodated with traffic lanes on historic narrow streets. To address this, many streets were changed to shared public ways in order to refocus the space on pedestrian traffic and provide sufficient space for ADA compliant travel. Now cars may use the streets, but pedestrians have the right-of-way on the whole street. Since the first shared public ways were completed, the public has been enthusiastic about their success and requested that many more streets be converted.



## Guidelines

### *Pedestrian Areas*

Shared public ways should be designed to emphasize their pedestrian and public open space character to differentiate them from traditional streets.

On right-of-ways greater than 15 feet in width, shared public ways should include pedestrian-only zones as differentiated from a shared zone. The separate zones should be differentiated through the use of visual detectable cues as described below. Right-of-ways less than 15 feet in width do not need to differentiate between separate zones.

In addition, shared public ways should provide the following pedestrian-oriented elements:

- **Alternative paving materials** patterns distinct from traditional streets. Paving should appear as an integrated, coherent design of patterns, materials, and colors. Paving textures should be smooth and vibration free. Where surface materials are coarse enough to impede wheelchair circulation, a continuous 4' pedestrian path of ADA-compliant smooth materials must be provided to lessen vibration impacts on individuals using wheelchairs. See also Section 6.4.

- **Small plazas or vehicle-free spaces** adjacent to the shared zone that may alternate from side to side to create chicanes, or be interspersed among passenger loading zones, driveways or parking spaces.

- **Landscaping, seating and other streetscape amenities** or furniture located and spaced to allow visual permeability and barrier-free pedestrian movement through the entire shared public way even when vehicles are present.

- **Vehicle closures on an intermittent or temporary basis** for events, restaurant seating, markets, etc.

### *Visual/Tactile Cues*

Visual/tactile cues should be provided to identify the presence of a shared public way as distinct from a traditional street, and to delineate between pedestrian-only and shared zones. Visual/tactile cues should be provided at all edges between pedestrian-only and shared zones, including from the crossing sidewalk. Visual/tactile cues should not impair the potential use of the entire right-of-way by all users.

A variety of materials, treatments and objects may be incorporated into creating visual/tactile cues. Combinations of elements may be used to create a more vibrant environ-

ment. Acceptable visual/tactile cues include but are not limited to the following:

- changes of material texture (cobble or rough surfaces at shared zones contrasting to smoother surfaces at pedestrian-only zones, or use of cobbled stone bands between pedestrian-only and shared zones);
- changes of material color and contrast (light on dark or dark on light);
- use of ½ inch maximum beveled transitions in surface treatment;
- use of caning detectable wayfinding or pathing materials (tactile tiles, ½-inch maximum height material ridges or domed material, etc);
- landscaping and raised planters;
- street furniture such as benches, seating ledges, or trash cans;
- bollards, railings and other architectural elements; and
- temporary or movable objects, such as swinging gates, movable planter boxes or retractable bollards.

## ➔ Visual/Tactile Detection in Shared Public Ways

Visual/tactile cues may serve the specific needs of individuals with different types of disabilities. Visual cues serve individuals with low vision. Tactile cues may serve as means for wayfinding as a cane-detectable edge, “shoreline” or pathing. The type and use of treatments is dependant upon the context and uses which may occur in the shared public way.

The use, design and placement of visual/tactile cues should permit effortless permeability of pedestrian circulation between pedestrian-only zones and shared zones. The spacing of vertical objects may serve to prohibit vehicles from entering pedestrian-only zones or other open space plazas or park areas. The placement of vertical and/or caning detectable materials should be aligned to reinforce edges and “shoreline” path markings. The spacing of these vertical objects should allow for continuous and unen-

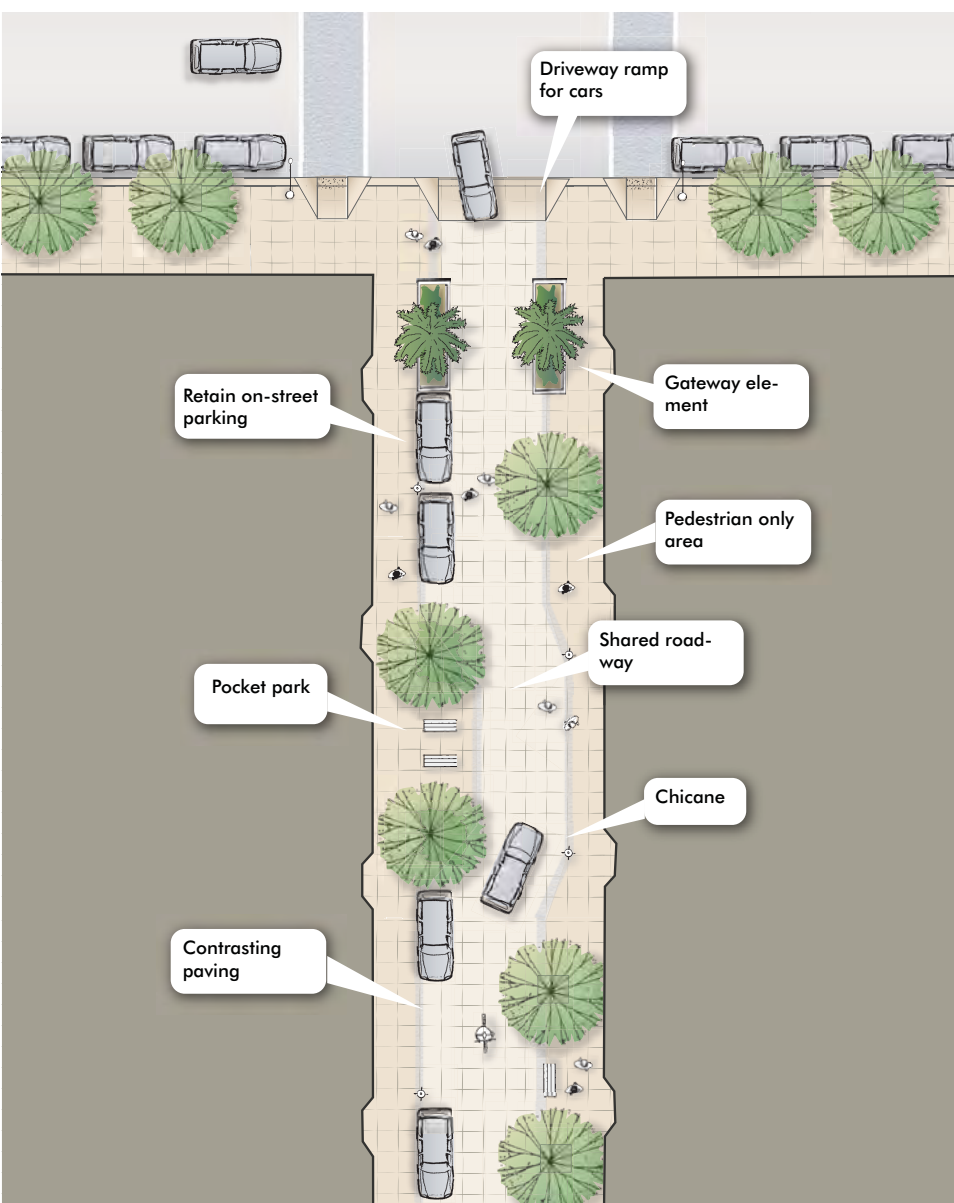
cumbered pedestrian movement along a shared zone even when vehicles are present, and support the overall use of the shared public way as usable open space.

Per California Building Code (Section 1133B.8.5), if a walk crosses or adjoins hazardous vehicular areas, and the walking surfaces are not separated by curbs, railings or other elements between pedestrian areas and vehicular areas, the boundary between the areas shall be defined by a continuous detectable warning which is 36 inches minimum wide and complying to DPW and State of California technical standard. As noted in definitions, shared public ways are not hazardous vehicular areas, and contain restrictions that mitigate this issue. Curb ramps with detectable warnings are required at pedestrian crossings that intersect raised curbs, if adjacent to hazardous vehicular areas (standard streets).

- ▼ Bollards or other vertical elements effectively separate shared zones from pedestrian-only zones on a shared public way.







▲ Diagram of a shared public way

Vertical materials or objects should have color or visual contrast with ground surface materials.

Transit malls must provide detectable warnings (or other detectable element such as a curb, raised planter, or other architectural barrier) between pedestrian areas and public transit lanes (bus lanes, light rail tracks, and the like). Detectable warnings must comply with DPW standards for detectable materials.

Where a shared public way leads to curbs, crosswalks and standard streets, curb ramps with detectable warnings must be provided.

#### *Traffic calming*

Shared public ways should utilize traffic control and calming strategies to slow traffic and emphasize the pedestrian nature of the space. On shared public ways, vehicles and bicyclists must yield to pedestrians. Shared public ways should have a posted speed limit of no more than 10 miles per hour.

Traffic calming strategies appropriate to shared public ways include but are not limited to:

- **Gateways.** Narrowing the entrance to the shared zone of the shared public way at the entrance from a standard street. Gateways may include flanking raised planters or vertical pylons or temporary element such as motorized gates or retractable bollards. They should not block crossing sidewalks.
- **Driveway treatments.** Raising the entrance to the shared public way to the level of adjacent sidewalks such that vehicles and bicycles must ascend a driveway apron to access the shared public way.
- **Signage.** Signage posting speed limits, instruction to yield to pedestrians and other information, such as name of the public space, or other signage indicating pedestrian priority. (Design considerations for signage should incorporate appropriate aesthetics that reflect the nature and character of the particular shared public way).

→ **Paving materials.** Durable, textural material changes at the gateway to the shared public way, such as a band of rough cobblestones, storm drainage grates or textural material bands in pavement that provide a sense of low vibration when a vehicle drives over the material. Color and material contrast (light on dark, dark on light) can also distinguish changes between a standard street and the shared public way and send a cue to drivers that they are in a pedestrian-priority space and must slow down.

→ **Chicanes.** Introducing serpentine pathways for vehicle and bicycle travel, employing horizontal shifts (chicanes) through placement of landscaping, bollards, street furniture, parking, and other streetscape elements, while preserving unencumbered pedestrian travel.

#### *Other*

Shared public ways may or may not be accepted for maintenance and liability by the City and County of San Francisco. Responsibility for maintenance of all zones of shared public ways should be determined prior to approval of a shared public way.

Design of shared public ways should solicit public input on a project by project basis, including participation and input by individuals with disabilities and groups that represent individuals with disabilities, including people with visual impairments.

Primary access to large shared or common garages should be located away from shared public ways and onto alleys or streets designed for more regular automobile use wherever possible.

Shared public ways should be designed to drain away from buildings, either toward the center of the street, with a side-running gutter on either edge of the central space, or to other stormwater drainage features. See Section 6.2.



## PEDESTRIAN-ONLY STREETS

On streets with substantial pedestrian activity, active land uses, and limited need for vehicular access, temporary or permanent street closure to vehicles may be considered to encourage pedestrian use. Pedestrian amenities, including seating, landscaping, pedestrian lighting, retail displays, and café seating should be located in the street right-of-way to help activate the space.

There are three potential types of street closure:

- **Temporary closures:** Streets may be closed for short, pre-determined hours of the day or week, such as weekends, evenings, or special occasions.
- **Pedestrian malls:** Pedestrian malls are permanent closures in areas used by high volumes of pedestrians, such as tourist and major downtown shopping areas.
- **Transit malls:** Transit malls are a type of street closure that close the street to private automobiles, but continue to allow use by transit vehicles.

Pedestrian-only streets may be considered on streets that:

- do not have any parking or loading access, garages, or driveways (or for temporary closures, where parking and loading access may be limited to times of the day when the street is open to vehicular traffic);
- have through traffic of fewer than 100 cars per hour; and
- do not have transit service (except for transit malls).

On streets that do not meet all of these criteria, pedestrian-only streets may still be appropriate pursuant to additional study and environmental review.

### Guidelines

Bollards, landscaping, or other gateway elements should be placed at the intersections of the streets to be closed to vehicles and the crossing street to discourage cars from accidentally turning into pedestrian-only streets and to remind pedestrians they have reached a transition point and should be aware of vehicles.

Permanently closed streets should incorporate landscaping, seating, special paving, public art, and other pedestrian-supportive elements in the full public right-of-way – the right-of-way should be designed holistically from property line to property line.

A clear 14 foot path should be maintained through permanently closed areas for emergency vehicle and delivery access. This path does not need to be straight, but should account for truck maneuverability and required clearances for emergency vehicle operations. Removable or automatically retractable bollards may be used to allow emergency vehicles to access areas otherwise closed to vehicle use.

In transit malls, pavement treatments using material and/or color changes should be used to distinguish transit lanes from pedestrian areas. Transit malls should follow the guidelines for shared public ways, previous section.

Single-surface treatments should be used for pedestrian malls to remove tripping hazards and obstacles to people with mobility impairments posed by roadway curbs. Single-surface treatments are appropriate to streets that will be frequently used for temporary closures as well – these streets should follow the guidelines for shared public ways, previous section.



▲ The 16th Street Transit Mall in Denver provides standard sidewalks for pedestrians to walk along storefronts, dedicated lanes for transit vehicles, and a wide array of amenities and landscaping in the center of the right-of-way



Photo: Ellen Vanderslice, Portland Office of Transportation



- ◀ 1. The first block of Powell Street, near Market Street, is a transit mall, which allows pedestrians full use of the street except when transit vehicles (cable cars) are present
2. Belden Lane is a temporary pedestrian mall with cafe seating at the lunch hour
3. Portland's Festival Streets are closed for only a few days a year for the fall Harvest Festival; at other times, they act as a shared public way.



## PUBLIC STAIRS

Public stairs enhance the experience of the natural hillsides that help define San Francisco's distinctive identity and, by nature of being pedestrian only, provide unique urban design opportunities.

Public stairs should be used to provide direct pedestrian routes between hillside locations that might otherwise require a pedestrian to travel a significant distance out of their way to connect by sidewalks. Stairs should also be used to provide an alternative to very steep sidewalks along streets.

### Guidelines

The minimum width for a public stairway should be 4 feet.

The riser height and tread depth of each stair should be uniform, with treads no less than 11 inches deep.

- The following formula can be used to determine appropriate tread to riser ratio:  $2R + T = 26$  to  $27$  inches, where R = riser and T = tread.
- Risers should be solid with nosing undersides.

Landings should be provided at frequent intervals to provide rest areas and overlooks, and should provide seating where space allows. The maximum distance between landings should be 12 feet whenever feasible given topography and other existing conditions. The minimum length of the landing should be five feet or equal to the width of the stairway. A continuous handrail that complies with ADA requirements should be provided.

Surface materials should be durable, provide a slip-resistant walking surface—including a contrasting color as per ADA—and be subject to regular inspection and maintenance.

Stair placement, landscaping, and lighting should contribute to visibility to and from the stairway, to improve pedestrian safety and security. Pedestrian scale lighting should be provided at landings to improve safety and comfort at night. Light poles should be located for easy maintainability.

Landscaping should be provided adjacent to stairways. Stairways should be designed to prevent the accumulation of water.

Signage should be provided to indicate that the stair is public right-of-way and should inform users where the stair leads, (e.g. "Public Stairway to Liberty Street"). Signage should alert pedestrians to alternative accessible routes, either along public sidewalks or via ramps where possible.

Technical provisions for accessible features appropriate to public stairs may be found in section 4.7 of ADAAG.

- ▼ Public stairs may incorporate public art, as in the Tiled Steps Project in the Sunset District







# CHAPTER

# BOOK

FITING AIDS | HEALTHCARE FOUNDATION



CHAPTER

# 6.0

## Streetscape Elements

- 6.1 Urban Forest
- 6.2 Stormwater Management Tools
- 6.3 Lighting
- 6.4 Paving
- 6.5 Site Furnishings
- 6.6 Utilities and Driveways

# GUIDE: STREETSCAPE ELEMENTS

Trees and landscaping, lighting, pedestrian furnishings, paving, and other elements fill the spaces of the streetscape with life, light, color, and texture and make a street a comfortable, interesting, and usable space for people.



**Streetscape elements are those functional and aesthetic items in pedestrian spaces that provide amenity and utility to pedestrians and other street users.**

Streetscape elements discussed in this chapter include:

**Urban Forest:** All plantings in the right-of-way, including street trees, understory planting (ground landscaping), and above-ground planting (planter boxes and hanging baskets)

**Stormwater Management Tools:** Plantings, permeable paving, and other facilities to retain, detain, convey, infiltrate, and treat stormwater

**Lighting:** Both roadway and pedestrian lighting, including poles and fixtures, and light quality

**Paving:** Standard materials as well as special paving treatments

**Site Furnishings:** Other pedestrian amenities and functional elements, including: benches and seating, bicycle racks, bollards, flowerstands, kiosks, newsracks, parking meters, public art, sidewalk restrooms, traffic and parking signs, trash receptacles, and signage and gateways

**Utilities and Driveways:** Overhead, surface-mounted, and sub-surface utilities including all poles, trenches, boxes, vaults, vents, and valves, and driveways to access properties.





# Urban Forest

## 6.1

The following section provides general principles that should guide how the City considers its urban forest, which includes all trees and landscaping. Recommendations for street trees and landscaping elements are provided in specific sub-sections.

### ➔ In this section: Urban Forest

- Street trees
- Understory landscaping
- Above-ground plantings

The urban forest includes any landscaping planted in the public right-of-way, including trees, understory plantings, and above ground plantings. Planting in the public right-of-way enhances the physical, ecological, and cultural aspects of the city, including:

- ➔ **Environmental:** Trees and landscaping make important contributions to the urban environment by reducing air pollution, ameliorating urban heat islands, improving hydrologic conditions, sequestering carbon, and contributing to wildlife habitat. Use of drought-tolerant trees and landscaping can aide water conservation efforts.
- ➔ **Economic:** Trees and landscaping can increase property values, increase commercial spending, and reduce maintenance costs of other streetscape elements.

- ➔ **Aesthetic:** The visual characteristics of street trees and landscaping (form, color, texture) add greatly to the aesthetics of urban streets and can enhance the civic qualities of the public environment.
- ➔ **Psychological:** People derive psychological benefits from symbolic and physical contact with nature provided by a green environment. A planted streetscape provides relief from an otherwise built out urban environment.
- ➔ **Social:** Opportunities for new social contacts, community identity, and the opportunity to contribute to the establishment and care of a community feature are afforded by the presence of street trees and planting.
- ➔ **Safety:** Consistent tree plantings along a street narrow the perceived width of a street, encouraging decreased vehicular speed and increased awareness of pedestrians.

▼ Moraga Street





**GUIDELINES**

Selecting Plant Types

Street trees and other landscaping should be used to create a distinct character for specific streets and neighborhoods. Trees and landscaping should be designed in harmony with street lighting and sidewalk amenities and the building context. Trees and plants vary in their aesthetic appearance due to variations in form, texture, foliar density/visual permeability, seasonal presence of flowers, seasonal color, bark characteristics, and persistence of leaves (evergreen vs. deciduous). Aesthetic appearance should be taken into account in making design decisions for the public right-of-way. New planting added to existing streets should be in visual harmony with existing trees and planting. Selection of planting material should be used to enhance the identity of streets important to the city pattern.

In view of global climate change, consideration should be given to future watering needs and heat resistance of species selected for planting. Landscape practices should follow xeriscape principles and drought-tolerant species should be used to meet the increased dryness associated with the anticipated future climate of San Francisco.

Plant material selection should account for performance in the urban environment, including drought tolerance and hardiness. Unfortunately, many native species do not do well in harsh urban conditions. Any plant species selected for planting should be adapted to soil and microclimate conditions and should serve an intended functional or aesthetic role. In some cases, the drought tolerant character of some native species may make them particularly suited for planting; however, past performance of the species in terms of durability, longevity, wind resistance, and high branching to provide line-of-sight for pedestrians and vehicles should also be considered. Native plants and trees should

be considered when a native species is suited to the site and will serve the roles for which the planting is intended. They should also be considered for stormwater plantings, areas of habitat value or connections, or for educational purposes.

Evergreen tree species should be used where it is desired to maintain foliage through the winter months or to enhance ecological performance by allowing leaves to slow stormwater during the rainier season. Deciduous trees should be considered for their ability to allow sunlight in the winter months

Climate and Soil

Placement of trees and landscaping should reflect an understanding of local soil and climate conditions. Recommended trees for different San Francisco environments have been developed both by the Department of Public Works (Bureau of Urban Forestry) and the Friends of the Urban Forest in relation to the environment identified in the microclimates map.

Before planting, current soil conditions should be evaluated and the soil amended to create the most beneficial growing conditions for trees and landscaping. Mulches should be considered to reduce erosion and decrease soil desiccation.

Engineered soils (for example structural soil), which can contribute to better tree health while protecting paved surfaces from root damage, may be appropriate in some locations.

**OTHER CONSIDERATIONS**

**Stormwater management:** The design of planting areas should consider including appropriate conditions for improved stormwater detention and infiltration. See Section 6.2. See also the Stormwater Design Guidelines Vegetation Palette for planting ideas.

▶ Existing sidewalks may be retrofit to include simple but attractive planting areas







**Reuse of underused right-of-way space:** Many spaces that occur within the public right-of-way may be considered for trees and other plantings. These spaces include traffic circles, excess space where two street grids intersect, parking lane planters, and other unique spaces. In some cases, small groves of trees may be planted in these reclaimed spaces at a greater density than would be typically possible for street trees. See section 5.8.

**Culturally-sensitive plantings:** The variety of cultural backgrounds of the people living in San Francisco should be considered in the selection and planting of trees in certain neighborhoods and adjacent to particular civic buildings. For example, in neighborhoods with a relatively high density of residents of Chinese descent, tree plantings might adhere to the principles of 'feng shui'. Other ethnic groups place particular value on certain tree species and would like to see them planted in their neighborhoods. Outreach to different cultural groups should be incorporated into site specific plans for tree planting in the public right-of-way.

**Urban forest as habitat:** A variety of native and exotic wildlife species make use of trees and landscaping in the city. Trees and landscaping provide cover, nesting sites, food, and a source of water. Street trees and landscaping provide corridors for the movement of many species and serve as important links between parks and open spaces throughout the city. Future tree planting and street landscaping projects should consider existing linkages between parks currently provided by street trees and address gaps by locating new plantings in a supportive way.

**Personal security:** Personal security of people using the public right-of-way is influenced by trees and other plantings. Trees and shrubs that do not obstruct views, interfere with street and pedestrian lighting, or block potential escape routes enhance personal security. Trees and shrubs should be pruned and maintained to ensure good street level visibility and avoidance of interference with street and pedestrian lighting. Box hedges over 3 feet in height should be avoided, as they may obscure visibility or constrict paths of travel.



➔ Soils and Microclimates Map

**THE COASTAL ZONE**

AREA 1: Cool temperatures; foggy to clear days; light winds; sand and loamy soils

AREA 2: Cool to moderate temperatures; foggy to clear days; light winds; sandy and loamy soils

AREA 3: Cool temperatures; foggy; salt air; heavy winds; sandy soil

**THE TRANSITION ZONE**

AREA 4: Cool to moderate temperatures; foggy to clear days; light winds; sand, clay, loam, rock soil

AREA 5: Cool to moderate temperatures; clear days with lightfog; light winds; sand, clay, loam, rock soil

**THE BAY ZONE**

AREA 6: Moderate to hot temperatures; clear days; light winds; sand, clay, loam, rock soil

AREA 7: Moderate to hot temperatures; clear days; heavy wind; sand clay, loam, rock soil

## Street Trees

Street trees are the most important organizing element of the streetscape environment. Appropriate tree species selection and location and design of the planting site will ensure the healthy growth and longevity of trees, enhance streetscape character, and maximize the City's investment. It has been demonstrated that street trees enhance property values in residential neighborhoods and commercial areas.

### ➔ PLACEMENT

Street trees are typically planted in tree basins (sidewalk cut outs) in sidewalks. Where planting strips of sufficient width occur between sidewalks and streets, it is not necessary to create independent tree basins for trees. Ground-cover landscaping should be included in planting basins larger than standard size. In limited circumstances, trees may also be planted in above ground planters. Planting strips and above ground planters are addressed in the following sections.

When adding trees to an existing streetscape, movable site furnishings should be relocated, where feasible, to allow for street tree planting in an appropriate spacing. If unmovable sidewalk elements interfere with a planting sequence, site the tree a few feet in either direction to accommodate obstacles. When designing a new or renovating an existing street, locate or relocate utilities and other elements where feasible to attain a regular tree spacing.

### ➔ GUIDELINES

#### Species Selection

Tree species selection and placement should be consistent with the goals of a particular street. See Section 4.1: Street Types.

Ceremonial streets, commercial streets, major throughways, and other streets important to the city pattern should use

formal, consistent planting palettes chosen for their distinct design qualities to provide a strong aesthetic character and facilitate place recognition. Neighborhood residential or smaller streets may use a more diverse, less formal planting palette to indicate neighborhood preference and create a rich planting variety. On DPW maintained streets, the Bureau of Urban Forestry may require specific tree species.

Consistent plantings, flowering species, and accent trees add aesthetic value. Accent trees, distinguished by their contrasting color, texture, or size, may be used to alert motorists to approaching intersections or mark the entrances of city parks and plazas.

On formal streets with sufficient width, allées—a double row of trees—should be used to create a distinctive design.

Appropriate tree species selection should consider:

- ➔ form, mature size, color, and texture to reflect the urban design goals of a street;
- ➔ the mature tree canopy with respect to how it may affect street and pedestrian lighting or views of signage and building fronts;
- ➔ the potential for root systems to affect sidewalks, curbs, and utilities ; and
- ➔ impacts and constraints created by local climate.

Generally:

- ➔ Trees with columnar form are appropriate for narrower planting spaces such as small streets, alleys, and narrow medians.
- ➔ Trees with overarching canopies and medium density foliage are appropriate on wider streets, such as mixed-use streets, throughways, and boulevards.
- ➔ Medium-sized trees with light to medium density foliage are appropriate on neighborhood residential and commercial streets.

### Size

Minimum size requirements for trees to be planted in tree basins in the sidewalk are as follows:

- ➔ Caliper (trunk diameter) of trees to be planted should be a minimum of 2 inches at 8 feet of height (exceptions should be considered for desired species that may not attain this caliper size as a 24-inch box specimen).
- ➔ Minimum tree size at planting is a 24-inch box; 15-inch box specimens and smaller caliper sizes should be allowed for volunteer efforts and property owner initiated replacement.
- ➔ Tree branches that extend into the path of travel must maintain 80 inches of vertical clearance.

### ➔ Characteristics of Trees for Different Climatic Zones

The city may be divided into three climatic zones: Coastal (Fog Belt), Transition, and Bay (Sun Belt). The Coastal Zone is characterized by cool temperatures, dense summer fog, and prevailing westerly winds. This zone is best divided into a coastline and interior zone due to differences in wind exposure and salt laden air; consideration should also be given to the orientation of streets, as east-west running streets generally experience more wind exposure. The Transition Zone has cool to moderate temperatures, light fog, sunny skies, and diminished wind velocities. The Bay Zone supports warm temperatures, skies that are dry, clear, and sunny, and generally light winds.

- General characteristics of trees best adapted to the Coastal Zone include trees of lower stature (up to 25 feet tall), evergreen species, and trees that are wind tolerant.
- Trees for the transition zone need some wind resistance, should be of medium stature (25 to 50 feet tall), and may be either deciduous or evergreen.
- The Bay Zone provides an environment more suited to a wider variety of trees. Trees that may be used include those of taller stature (over 50 feet tall) and those not noted for wind resistance, unless planted at higher elevation sites within the Bay Zone, which are subject to higher velocity winds (e.g., portions of Bernal Heights, Nob Hill, and Telegraph Hill).



## Location and Spacing

Street tree spacing should be determined by the expected mature size of the tree. Generally, trees should be planted with the following spacing:

- Small trees (<20 feet crown diameter at maturity) should be planted 15 to 20 feet on center.
- Medium sized trees (20 to 35 feet crown diameter at maturity) should be planted 20 to 25 feet on center.
- Large trees (>35 feet crown diameter at maturity) should be planted 35 feet on center.

These guidelines may suggest a crowding of the canopies of adjacent trees, but trees will adapt to a slight degree of crowding and still remain healthy. Slight crowding will insure a continuous tree canopy along the street. Certain trees, such as palms and many ornamental species may be used on ceremonial streets, although they may not result in a continuous canopy.



Tree spacing should create a continuous canopy and buffering effect between the roadway and the sidewalk. Closer spacing is desirable on heavily traveled streets to create a palisade view looking down the sidewalk.

These spacing guidelines should be considered general targets that may be adjusted to local street conditions such as setbacks from corners, utilities, driveways, bus stops, and building entrances. To the greatest extent feasible, trees should be aligned to minimize interference with building entries, driveways, and utilities.

Where site constraints prevent maintaining an exact spacing, it is favorable to place a tree slightly off the desired rhythm than to leave a gap in the planting pattern.

Tree basins should be aligned so that the edges abutting the path of travel form a straight line along the block.

**Trees adjacent to streetscape elements:** Minimum guidelines for sidewalk element clearance from street trees (not ground landscaping) on a public sidewalk are:

→ Parking Sign	3 feet
→ Utility Boxes	3 feet
→ Parking Meters	3 feet
→ Pedestrian Furniture	3 feet
→ Sewers	5 feet
→ Fire Hydrants	5 feet
→ Traffic Sign	5 feet
→ Utility Poles	5 feet
→ Fire Escapes	10 feet

- ▲ Trees should be planted as near to corners as is practicable while retaining visibility

**Trees adjacent to accessible parking and passenger loading zones:** Street trees are not allowed adjacent to an accessible parking and passenger loading zones when the sidewalk is less than 12 feet wide. Street trees may be planted in these zones so long as 8 feet minimum clear from curb face to tree basin edge is maintained for the length of the zone.

**Trees at intersections:** Trees are especially valuable to pedestrians at intersections. Without street trees, intersections can be overwhelmingly large expanses of asphalt. The desire for trees should be balanced with concerns for sight distance and clear views of traffic control devices and street and pedestrian lighting requirements. Strategic placement and effective pruning of trees can improve pedestrian and motorist conditions and safety at intersections.

In order to maximize visibility of pedestrians waiting to cross the street and traffic signs and signals, trees within 25 feet of the corner property line on approach and 10 feet of the property line on exit, as traffic flows, should be pruned to ensure a 14 foot minimum height of the lowest branch. Trees adjacent to intersections should be large species with high branching canopies to maximize visibility and visually enclose the intersection.

Street trees should not be planted closer than 5 feet from the near side edge of the crosswalk. Landscaping may be planted within this zone using plant material with a maximum mature height of 3.5 feet above the roadway.

See DPW Director's Order #169,946 on tree planting.

**Trees adjacent to bus zones:** Trees can provide welcome shade at transit stops and a continuous canopy along the street, but should not interfere with the ability of people to board transit vehicles at stops. Trees adjacent to curbside bus zones should accommodate access to the bus doors. Trees should be planted no closer than 6 feet from a bus shelter. Trees should be planted in bus zones per the dimensions as shown in Figure 6.1. To reduce tripping hazards and maintain accessibility to the bus, individual tree basins should have a metal tree grate, or if placed in a continuous trench, the trench should be covered with an ADA-compliant surface material.

**Trees in Medians:** Trees may be planted in medians 4 feet or wider, including curbs. Trees planted in medians should have arching canopy structures that provide visibility without excessive pruning, or be upright and columnar in form. Tree species selected for planting on median strips that are 4 to 6 feet wide should be expected to grow to trunk diameters no greater than 12 inches. On median strips greater than 6 feet wide, trees obtaining larger diameters may be used.

Trees located in medians should have a vertical clearance of the lowest branch of 8 feet in height over the median, and 14 feet in height for any portion of the tree that overhangs the roadway. Shrubs located in the median should not exceed 3.5 feet above the roadway.

**Coordination with street lighting:** Street lighting should be coordinated with tree selection, placement, and pruning, so that tree canopies do not sit directly below street lighting. See Section 4.2. Overall Streetscape Guidelines, for detail. For new streets where lights and trees are being placed, street lights should be generally placed halfway inbetween trees. When trees are being added to an existing streetscape, the basin pattern should respond to the location of existing lighting.

**Trees and building projections:** The width of the fire escape balcony, projected down to the sidewalk, should remain clear of any trees or landscaping. Awnings, canopies, signs, and marquees may also present conflicts with street trees. New building projections should not compromise tree health or potential tree planting locations.

Size of Tree Basins

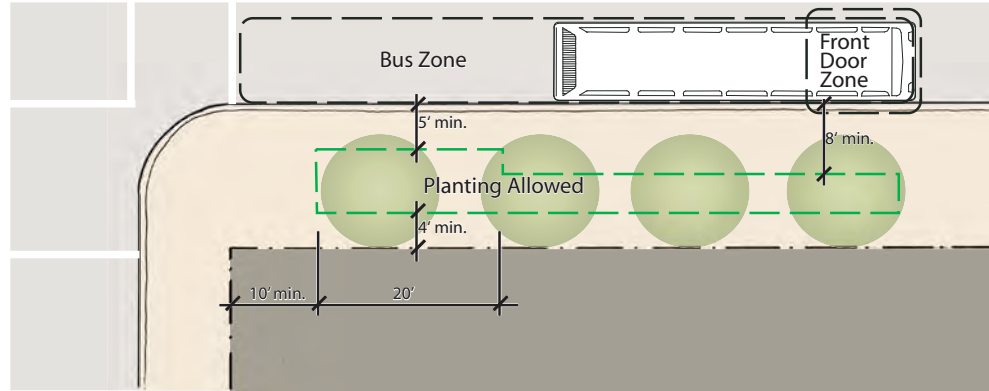
Trees need adequate surface area for root growth. Most tree species have the majority of their roots in the first 18 inches of soil. An important variable in tree basin design is the amount of surface area. Greater surface area provides for greater entry of water and oxygen into the soil.

Tree basins should meet the following the minimum size shown inFigure 6.3.

Basins may be square, rectangular, or have other shapes to meet the minimum size requirements. Linear planters may enable a design to achieve optimal tree basin size on narrow sidewalks.

Permeable surfacing increases access of tree roots to water and oxygen when the optimal tree basin size is not possible. Continuous trenching between tree basins (which can be covered by paving) should be used wherever possible to maintain the capacity of oxygen and water to enter the soil in a tree basin, particularly where minimum sized tree basins must be employed.

Far Side Bus Stop



Near Side Bus Stop

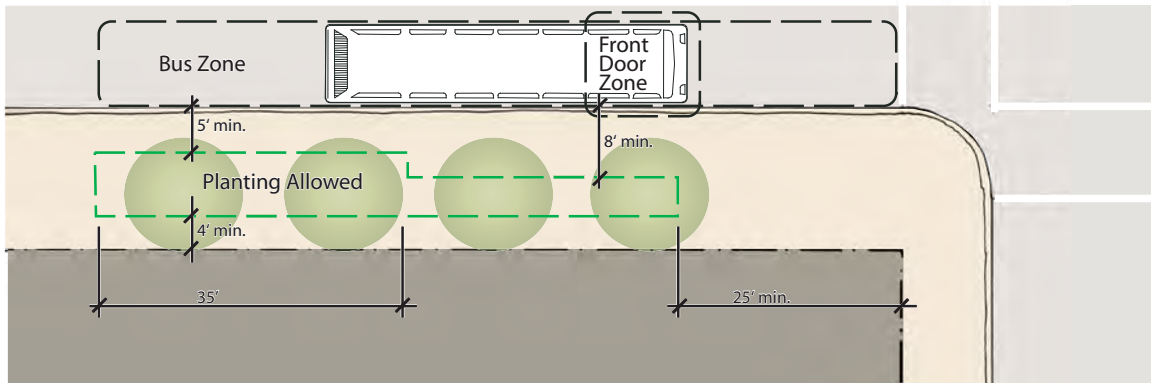


FIGURE 6.1  
TREE PLANTING  
IN BUS ZONES



► Trees in medians can provide a fuller canopy and visually narrow the street



FIGURE 6.2

## TREE CLEARANCE FROM STREET LIGHTS

SIZE OF TREE (At Maturity)	CLEARANCE
Small	No closer than 9 feet
Medium	No closer than 15 feet
Large	No closer than 21 feet

FIGURE 6.3

## MINIMUM BASIN SIZE

SIDEWALK WIDTH	STANDARD BASIN SIZE
6 1/2 to 7 1/2 feet	2 x 4 feet*
7 1/2 to 12 feet	3 by 4 feet
12 to 13 feet	4 by 4 feet
13 feet and wider	5 by 5 feet

\*Note: In this basin size, only small (upright) tree species, at maturity, should be planted as approved by DPW, Bureau of Urban Forestry



◀ Using cobbles or other paving stones protects the basin and still allows root access to water

Tree basin size should vary with the mature size of the tree species and soil conditions. Larger basins should be provided for larger trees where space permits.

## Grade and Surfacing

Landscaping with drought tolerant groundcovers, non-woody shrubs, or grasses is encouraged within the tree basin. Open soil in tree basins is discouraged. When landscaping is not used, the open basin area surrounding the base of the tree should be filled with sand set paving stones, cobbles or compacted decomposed granite (DG) to maintain a level surface.

Tree basin grade should be maintained at existing sidewalk grade.

- **Sand set paving stones or cobbles:** Where sand set paving stones or cobbles are used, they should generally be placed outside the root ball.
- **Decomposed granite (DG):** To account for settling of soil and DG, additional DG may need to be added during scheduled maintenance.

## Tree Basin Furnishings

**Tree Grates:** Tree grates and other structural basin covers are generally discouraged, as over time, they can become an obstacle or tripping hazard and can interfere with the diameter growth of trees, resulting in girdling and damage to trees. Maintenance of tree grates is costly, often requiring workers to expand the diameter of the opening as the girth of the trunk increases.

In limited locations, such as heavily traveled sidewalks where sidewalk width limits pedestrian movement at peak times, where a formal design treatment is desired, such as along ceremonial streets, or in bus zones, it may be necessary or desired to install tree grates to provide an adequate walking surface or design treatment.

Grates should be designed with easily removable inner rings to allow for the growth of the tree trunk. In limited circumstances such as extremely narrow sidewalks, tree grates may be counted toward the minimum clear path of travel; however, as they are difficult to maintain to an accessible standard, this is not a preferred solution.

Grates should have less than 1/2 inch spacing between rings to provide a safer walking surface and to prevent material from being trapped or falling into the basin.

Maintenance of grates used in high pedestrian traffic areas should include the periodic cleaning of grates and adjustment to eliminate any tripping hazard.

**Tree guards:** Tree guards are generally discouraged, but may be appropriate on heavily traveled sidewalks for the protection of newly planted trees. They are also appropriate adjacent to heavily used bus and light rail stops, around school buildings, and adjacent to other land uses with associated activities that may be considered detrimental to tree health and safety.

Tree guards should be of an attractive design, not possess any sharp edges, and be made of durable material. Tree guards should be a minimum of 18 inches wide to provide sufficient distance from the tree trunk at the time of planting. Tree guards are an opportunity to provide a special design and to incorporate artistic elements.

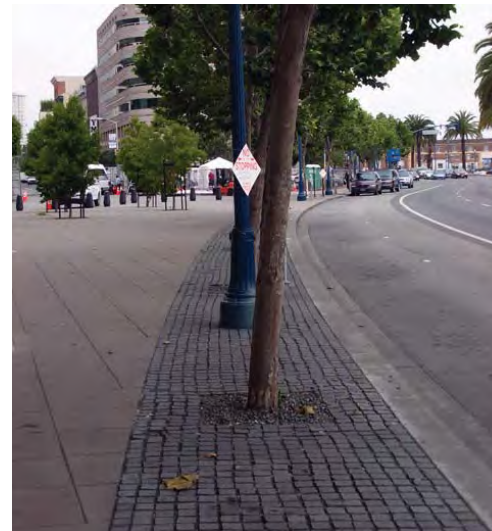
**Edging and planting guards:** Tree basins may be edged with low planting guards where sidewalks have appropriate clearances per Section 4.2. Edging treatments are appropriate for residential and commercial neighborhoods with moderate to low pedestrian traffic. Where used, the base of the guards must be a solid 4 inches to allow for cane detection. See DPW's Sidewalk Landscape Guidelines.

Planting guards may be constructed of wood or metal. Ornamental iron edging may be acceptable if it does not present any sharp edges that would pose a safety risk for pedestrians.

Edging the tree basin with a contrasting material such as cobbles or brick paving may be used as a design treatment.

Edging should not prevent water from moving off of the sidewalk and into the tree basin, and should be designed to allow rainwater from the sidewalk (in all cases) and/or the street (if specifically designed to do so) to flow into the planted area. Openings in the edge treatment can allow for water to pass through.

Where the base of landscaping is not at grade with the surrounding sidewalk, such as on sloped streets where planting is terraced and in stormwater infiltration planting areas, a 4 to 6 inch raised edging treatment should be installed around the landscaped area to delineate the presence of landscaping and grade change to people with visual impairments.



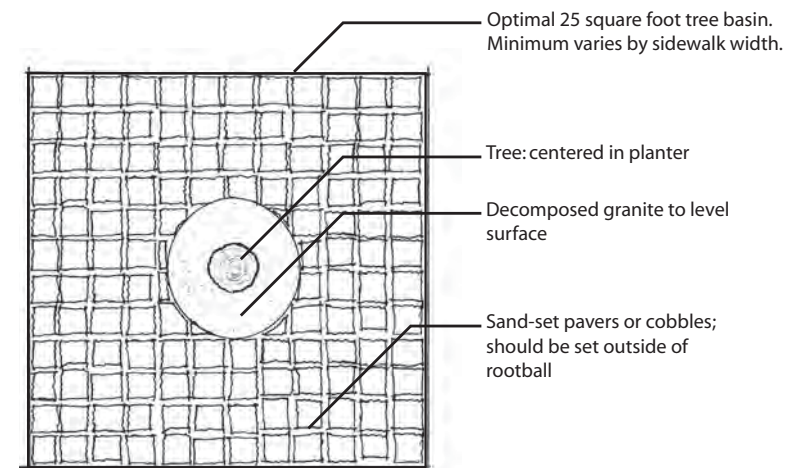
▲ Tree grates present an aesthetic urban design treatment; however, they may present difficulties for maintenance and tree health

## MAINTENANCE

### Pruning

- Pruning should be conducted under the supervision of a certified arborist. All tree maintenance work shall comply with Pruning Standards for Public Trees in the City & County of San Francisco, available from the DPW Bureau of Urban Forestry.
- On the pedestrian side of the sidewalk or median, the lowest branch that extends over the path of travel should provide an 80 inch minimum vertical clearance.
- On the vehicular traffic side of the sidewalk or median, the lowest branch should provide a 14 foot minimum clearance where branches extend beyond the curb or driveway.
- Newly planted trees should not have branches that extend beyond the perimeter of the tree basin or median below the 80 inch minimum vertical clearance.

- Tree foliage should be maintained to provide a minimum 6 foot clearance from any public street-light. Trees should not obscure traffic or parking signs, signals, or vehicular sightlines.
- Pruning may not result in topping trees; situations where tree canopies will require topping below light standards or utilities must be avoided. Trees with taller canopies should be used at a height above the street light or trees should be spaced so as to spread out between light standards.
- Trees should be pruned for 1 to 2 feet of clearance to building façade and building signage.
- Proper pruning and maintenance of trees should allow trees to develop healthily and retain their natural form.





## Understory Landscaping

Understory landscaping includes sidewalk planting strips and landscaping in tree basins, adding green space to sidewalks. They are most appropriate where frequent pedestrian traffic between parked cars and the sidewalk is not expected or where a pedestrian path can be provided for people moving between the sidewalk and parked cars. This simple and inexpensive addition to the streetscape adds aesthetic, habitat, and ecological value to the city's right-of-way.

Understory landscaping:

- reduces impervious area and surface runoff;
- naturally treats stormwater improving water quality;
- provides infiltration and groundwater recharge;
- provides habitat;
- adds aesthetic value and promotes community stewardship; and
- provides a buffer between the active pedestrian area of sidewalks and the street, enhancing pedestrian comfort.

### → PLACEMENT

Planting strips and sidewalk landscaping are suitable for many street types, including residential, commercial, mixed-use, and special streets. Planting strips can be located in sidewalks, parking lane planters, curb extensions, and medians.

More formal sidewalk buffer planting is generally appropriate for downtown, commercial, and special streets, whereas on residential streets plantings may have a more diverse character.

Planting strips can be located in most soil types, all microclimates, and where topography limits slopes to <10%; where existing topography exceeds 10% planters can be terraced to achieve <10% slopes within each landscaped area.

▼ Tree Basins can be lined or edged in many different ways



### ↶ GUIDELINES

The following section provides guidance on creating spaces for sidewalk landscaping beyond simply adding plants to a tree basin. Community sidewalk landscaping is permitted through DPW's Sidewalk Landscape Permit.

#### Species Selection

In addition to landscaping, street trees are strongly encouraged in sidewalk planting strips if planting areas are of sufficient width (see previous section).

Most plants are acceptable for understory landscaping; however, ivy and other invasive groundcovers should be avoided as they can provide protective cover for pests. Tall, dense bushes and hedges should also be avoided as they can limit visibility and accessibility.



Understory landscaping should use drought-tolerant species. Deep rooted native or drought-tolerant species have many benefits including tolerance to flooding and drought, low or no irrigation needed once established, improving water quality by filtering pollutants, and aerating and increasing the permeability of soils. Native and drought-tolerant species provide wildlife habitat and generally contribute to the health of the soil, and should be considered wherever understory landscaping projects are implemented.

Planting strips can be designed to detain, cleanse, and infiltrate stormwater. In more significant storm events, overflow from one planter can be channeled to the next. For more information see Section 6.2: Stormwater. In most cases, a street does not require re-crowning or other significant work to direct stormwater runoff to landscaped planters.

### Location and Spacing

Planting strips should be a minimum of 3 feet wide along a street where trees are to be planted. Narrower planting strips less than 3 feet wide are not recommended but can be adequate for narrow plants and vines adjacent to buildings.

Planting strips must maintain the minimum clear sidewalk width (“throughway zone”) adjacent to the planting strip

for the street type per Section 4.2. Per ADA regulations, in no cases may this be less than 4 feet in width.

Where parking lanes are present, planting strips must provide access from the sidewalk to and from parked cars (“edge zone”), per the following:

- Planters must leave a minimum 2 foot wide edge zone from face of curb (2 1/2 feet with angled or perpendicular parking).
- A minimum 4 foot wide walkable path should be provided to each parking space. The path should be aligned with the approximate location of the center of the parked vehicle.
- The edge zone and path for parked cars should be a walkable strip using a walkable paving material.

Planting strips should not be installed in the following locations:

- adjacent to an existing designated accessible parking or passenger loading zone, except plantings that maintain 8 feet of sidewalk through width;
- immediately adjacent to an existing crosswalk or in locations that impact curb ramps; and
- within 5 feet of a fire hydrant in any direction.



### Best Practice: Sidewalk Buffer Planting

Chicago, Illinois

Sidewalk planters are commonly found throughout Chicago. On blocks with sufficient sidewalk width, planters are installed on both sides of the path of travel. A walkway is typically provided along the curbside to provide access to the parking lane and to accommodate small utility facilities and signposts.



- ▶ Planting areas should include paths to allow people to walk to and access vehicles without damaging plants



### *Planting Along the Property Line*

On streets where there is not enough sidewalk space to install sidewalk landscaping in the furnishing zone or where sidewalk width allows, planting in the frontage zone should be considered. This strategy is particularly relevant at transit stops where sidewalk landscaping otherwise can not be placed adjacent to the street edge.

Property line planting strips that do not include trees may be as narrow as 6 to 12 inches. These can be designed as cut-outs in the sidewalk for vine plantings, or can be an area used for planter boxes or other containers.

Widened property line planting strips may contain trees if buildings along the property line are set-back from the sidewalk. Dimensions for planting strips with tree basins should follow the guidance in the previous section.

Shallow-rooted landscaping such as groundcovers, grasses and small shrubs should be used to minimize the risk of root damage to building foundations if there is no building setback.

Planting along the property line may also incorporate creeping vines and other similar materials to cover a building façade. Such treatments, called living walls or rain screens, can have stormwater management value as well (See Section 6.2: Stormwater).

### *Planting in Medians and in Parking Lanes*

Understory planting should also be included in parking lane planters and medians as follows:

**Medians:** Understory planting should be included in medians greater than 4 feet in width, including curbs. Landscaping in medians is strongly encouraged wherever site conditions allow. Low maintenance, drought tolerant species are encouraged.

A 2 foot wide path clear of plantings should be provided for maintenance workers where possible. Median edge treatments, curbs, and striped areas in the roadway all may count toward this area.

**Parking lane:** Understory planting should be included in parking lane planters with the same requirements as understory planting in sidewalk tree basins. See also Section 5.6: Parking Lane Treatments.

### Design of Planters

#### *Other Streetscape Elements within Planting Strips*

Parking signs, street lights, utility poles, and other above-ground infrastructure located in planting strips should be set in concrete for adequate anchoring.

Planting strips should provide access to site furnishings including mailboxes, trash receptacles, bike racks, and other street fixtures, not including parking meters.

Points of access to underground utilities should remain accessible through the plantings, but may be set within the planting strip. Areas that align with the planting strip but

are not planted should be delineated by a sidewalk paving treatment or material that provides a visually contrasting surface, such as DG, bricks, or other walkable materials.

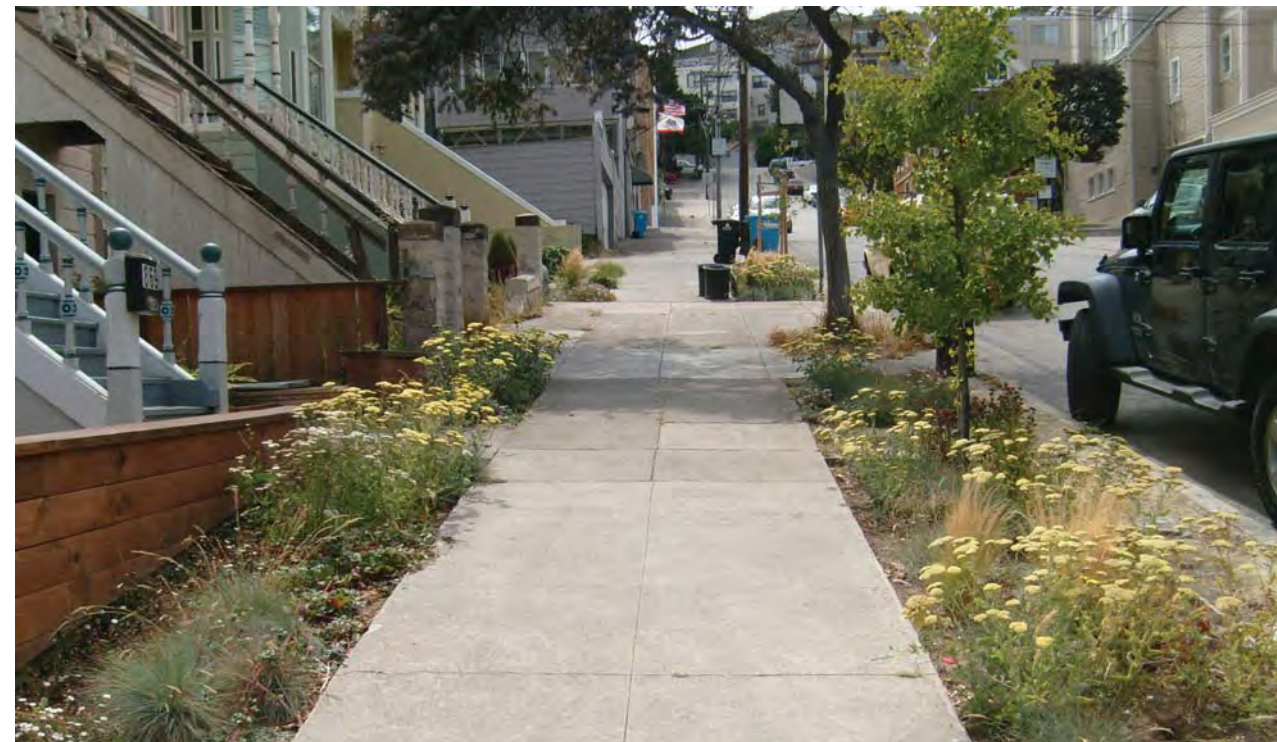
#### *Terraced Planters*

Planter strips should be terraced on sites with slope greater than 10% to avoid soil erosion and spillage on to the sidewalk. Landscaping and edging treatments should allow water to drain from the sidewalk into the landscaped area.

In areas with a known high water table and other subsoil issues, sites should be reviewed on a case-by-case basis as to their appropriateness for permeable landscaping. In such cases, an underdrain system should be used to drain the soil. See Section 6.2.

#### *Planter Furnishings*

See Street Trees: Tree Basin Furnishings, previous section.



## Above-Ground Landscaping

Above-ground planters include potted planters, raised planter beds, hanging baskets, and other containerized bodies for trees and landscaping. Continuous and more substantial plantings in extended planter boxes can provide a buffer between the roadway and sidewalks, creating a more quiet and comfortable pedestrian environment. However, above-ground planters often present challenges for maintenance.

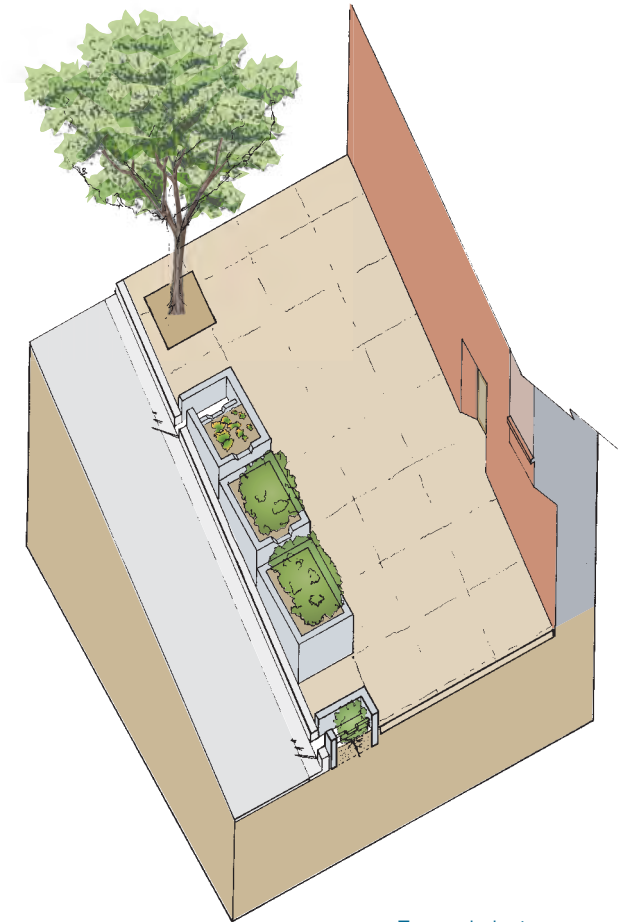
### ➔ PLACEMENT

Above ground planters are appropriate for locations where existing sidewalk space or soil conditions do not allow for planting in the ground, such as where major utilities or basements beneath the sidewalk exist.

On downtown, commercial, and mixed-use streets, above ground planters may be appropriate (or required) to delineate the edge of sidewalk seating areas or outdoor displays. Many businesses and larger developments on all street types may include planters at street level as an architectural element, especially when integrating seating into the planter edge.

Above ground planters should also be used as dividers at the edge of outdoor seating areas to provide a cane detectable edge. See Section 6.5.

Raised planters should be considered an exception rather than a rule because of increased maintenance needs and water requirements.



▲ Terraced planters should be used on sloping sites over 10% grade.



### ➔ Best Practice: 12th Avenue Green Street

Portland, Oregon

This project, in downtown Portland and completed in 2005, involved converting the previously underutilized landscaped area between the sidewalk path of travel and the curb into a series of planters designed to slow, capture, cleanse and allow for infiltration of stormwater runoff. The project manages the street's stormwater runoff on site instead of discharging it into the storm drain system, which feeds directly into the Willamette River, creating environmental benefits and an urban amenity.

Runoff from 8,000 square feet of the street flows downhill along the curb until it reaches the first of four planters. The runoff is channeled into the planter through a 12 inch cut in the curb. In the planter, the water infiltrates into the soil. If the water in the planter reaches capacity, it exits through another curb cut, flows back into the street and enters the second planter downstream.

The runoff continues its downhill movement from planter to planter until all are at capacity. At that point, the water exits the last planter and enters the storm-drain system. The planters are able to manage nearly all of the street's annual street runoff, estimated at 180,000 gallons.



## GUIDELINES

Above ground planters should generally be a secondary alternative to in-sidewalk plantings.

### Container planting of trees

Trees planted in containers require high maintenance, show limited growth and vigor, and are often short lived. Container planting of trees is appropriate where trees are desired and where sub-grade conditions would otherwise preclude a tree.

Container plantings should follow the same spacing requirements for street trees discussed earlier in this section. Piped irrigation should be provided. Planters should not be smaller than 16 cubic feet and should be constructed of durable materials that complement the design aesthetic of the street. Materials should be resistant to vandalism and damage from motor vehicles. Opportunities for incorporating seating into the planter are encouraged.

- ▶ Hanging baskets are generally discouraged but may be used on key corridors where a plan for maintenance exists.



### Raised planter beds

Raised planter beds can be incorporated into larger sidewalk elements such as seating areas. Planter edges may be used as seating walls. Raised planters should meet all sidewalk clearances in Section 4.2.

### Hanging baskets

Hanging baskets can be added to a number of streetscape elements to add unique urban design detail and identity to a street or neighborhood. Use of drought tolerant perennials such as succulents is highly encouraged. Because hanging baskets are maintenance and resource intensive, they are not a preferred landscaping method. However, hanging baskets might be appropriate in some instances, such as where funded by community benefit districts (CBDs) or at important civic or ceremonial locations.

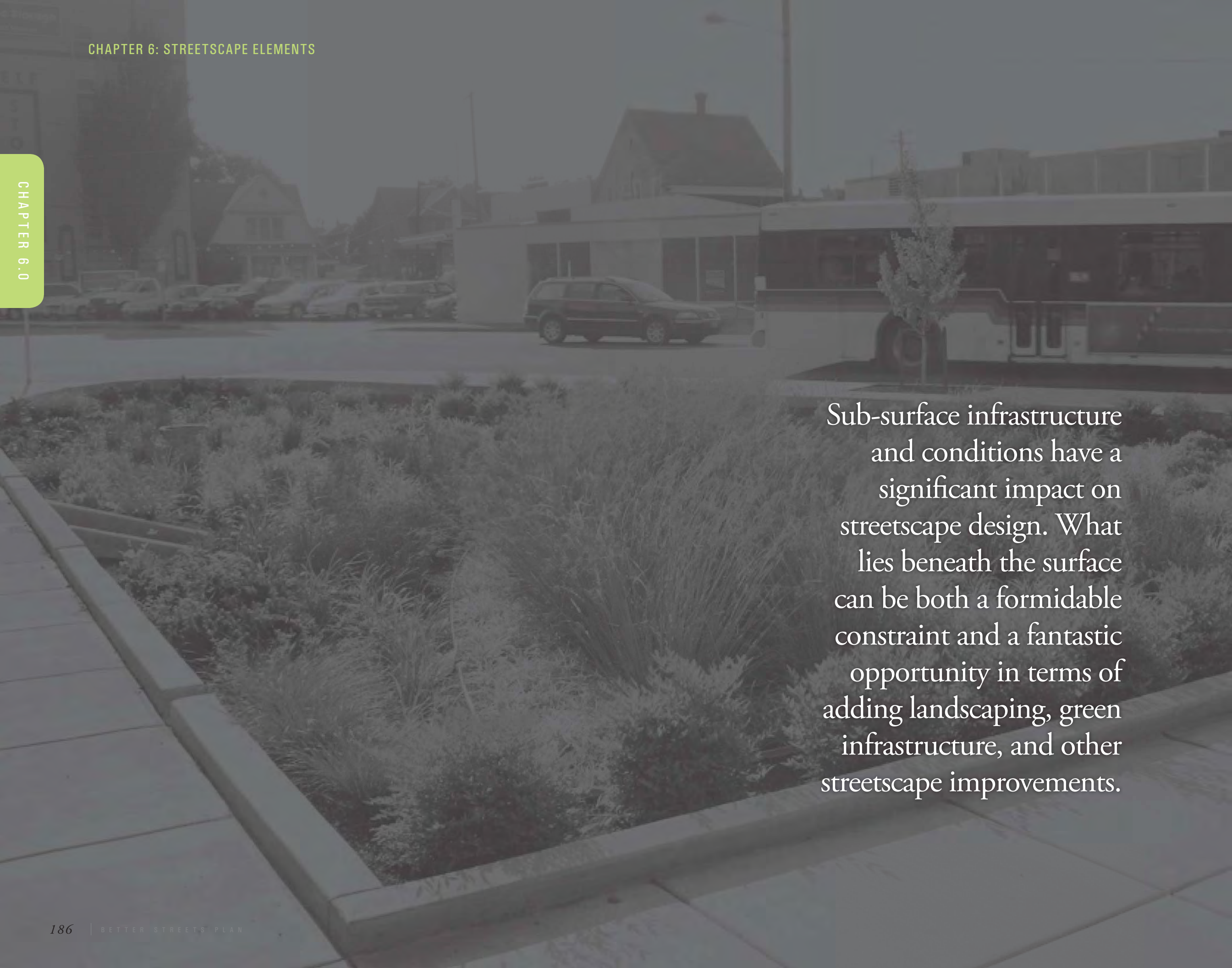
### Rain Screens/Living Walls

Rain screens are plantings on the exterior walls of buildings. They are an emerging technology which can remediate water pollution and attenuate peak stormwater runoff. See the San Francisco Stormwater Design Guidelines for more information.

- ▼ Raised planting beds create opportunities to integrate seating walls







Sub-surface infrastructure and conditions have a significant impact on streetscape design. What lies beneath the surface can be both a formidable constraint and a fantastic opportunity in terms of adding landscaping, green infrastructure, and other streetscape improvements.



# Stormwater Management Tools

## 6.2

**NOTE:** More information and technical design specifications for all stormwater management tools can be found in the *San Francisco Stormwater Design Guidelines*.

Concrete, asphalt, building roofs, and parking lots all prevent rainfall from absorbing into the ground. Instead, this rainfall collects into runoff, accumulating chemicals, oil, metals, bacteria, and other by-products of urban life. Left untreated, this polluted runoff contaminates the ecosystems of the bay and the ocean. Additionally, the hardening of the city’s surfaces keeps water from recharging groundwater aquifers, causing subsidence and other problems.

High quantities of runoff may also cause flooding and contribute to combined sewer discharges during large storm events. The tools presented in this section can help mitigate these environmental problems by removing or delaying the runoff stream and treating associated pollutants before stormwater is discharged into sewers and storm drains and, ultimately, to receiving water bodies such as the bay or ocean. For these reasons, wherever it is possible to do so,

water should be directed to stormwater features first, before entering catch basins. In addition to the ecological benefits that stormwater management tools can provide, these tools can be used to make the city’s streets more beautiful and enjoyable places to be.

This section presents stormwater management tools, individually referred to as “stormwater facilities,” that promote the advancement of Low Impact Design (LID). See sidebar, following page. These facilities have stormwater management benefits and contribute to streetscape aesthetics. The facilities are classified into broad types to help the user identify appropriate stormwater mitigation strategies for use within the range of street types.

Figure 6.4 presents the stormwater management tools described in this chapter and their typical functional benefits.

### ➔ In this section: Stormwater Tools

- Permeable Paving
- Bioretention
- Swales
- Vegetated Gutters
- Vegetated Buffer Strip
- Channels and Runnels
- Infiltration and Soakage Trench
- Infiltration Boardwalk





Choice of stormwater facilities should be based on the context of the surrounding streetscape (See Figure 6.5). These measures assume that a primary goal of the improvement is to mitigate stormwater effects; the *San Francisco Stormwater Design Guidelines* set quantifiable mitigation goals - see sidebar at right.

This section is guided by the principle that in most cases, any stormwater mitigation is favorable, and highlights the relationship between these measures and other benefits such as streetscape aesthetics, habitat, and placement.

In addition to its impact on stormwater quality and quantity, multi-purpose design of stormwater facilities can add aesthetic value to the city by providing varied landscaping, visually appealing pavement design and enhanced community spaces. They can also be combined with traffic calming features.

Stormwater tools can add health and value to the urban ecology by enhancing the linkage of existing parkways and parks for improved aesthetics and neighborhood community spaces. In addition, these localized vegetated areas can create new habitat for wildlife, particularly birds and butterflies. Finally, by reducing total stormwater flows, the use of stormwater management tools may decrease the cost to the City of pumping and treating stormwater.

FIGURE 6.4  
FUNCTIONS OF  
STORMWATER FACILITIES

	FUNCTION				Water Quality
	Detention	Retention	Infiltration	Conveyance	
Permeable Paving	○	○	○		○
Flow-Through and Infiltration Planters	○	○	○		○
Swales	○		○	○	○
Rain Gardens	○	○	○		○
Channels and Runnels				○	
Infiltration and Soakage Trench	○	○	○		○
Infiltration Boardwalks	○	○	○		

DEFINITIONS

**Best Management Practice (BMP):** Operating methods and/or structural devices used to reduce stormwater volume, peak flows, and/or pollutant concentrations of stormwater runoff through one or more of the following processes: evapo-transpiration, infiltration, detention, filtration, and biological and chemical treatment.

**Bioinfiltration:** A process that uses vegetation to capture and biologically degrade pollutants. Water is biologically treated while percolating through the system and into the existing soils, providing groundwater recharge.

**Bioretention:** A soil and plant-based retention practice that captures and biologically degrades pollutants as water infiltrates through sub-surface layers containing microbes that treat pollutants. Treated runoff is then slowly infiltrated and recharges the groundwater. These biological processes operate in all infiltration-based strategies, including the previously described retention systems.

**Conveyance:** The process of water moving from one place to another.

▼ Low-impact design (LID) prioritizes the use of small localized facilities that improve streetscape aesthetics in addition to stormwater quality.



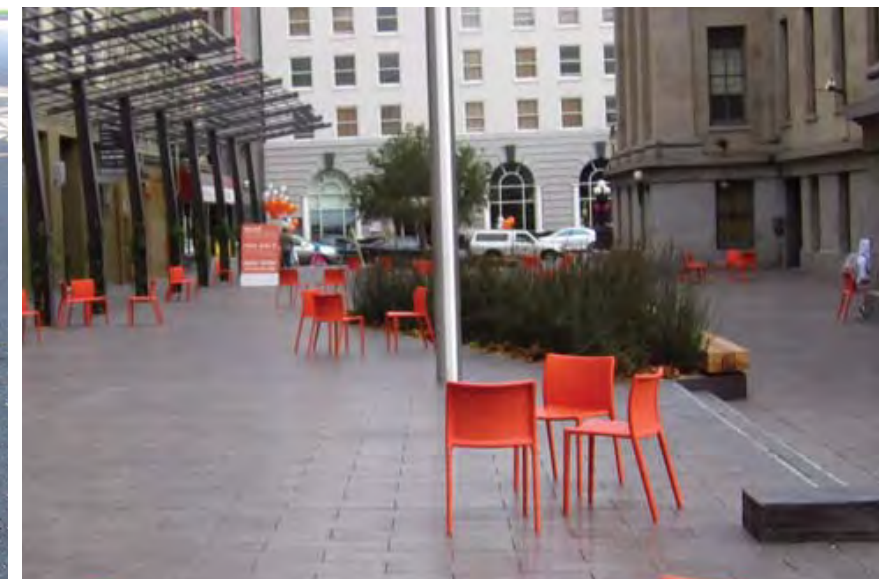
➔ Infiltration & The Stormwater Design Guidelines

The Better Streets Plan focuses on types of criteria appropriate to the public right-of-ways, and their applicability and design considerations for placement in the right-of-ways. Technical specifications for sizing and infiltration rates of stormwater management tools can be found in the *San Francisco Stormwater Design Guidelines* (SDG) Appendix A, as well as non-right-of-way strategies for treating and managing stormwater.

Development or redevelopment projects disturbing 5,000 square feet or more of the ground surface are required to manage stormwater on-site. Land disturbing activities include, but are not limited to, clearing, grading, filling excavation, or the addition or replacement of impervious surfaces. All projects must complete a stormwater control plan, those projects served by separate stormwater sewers must achieve LEED SS6.2 and those served by the combined sewer system must achieve LEED SS6.1.

Right-of-way projects associated with new and redevelopment projects located within the separate sewer areas will be required to comply with the *San Francisco Stormwater Design Guidelines*.

▼ San Francisco's Mint Plaza is designed with stormwater management in mind to convey stormwater through channels to a bio-retention facility.





## ➔ Low Impact Design (LID)

Low-Impact Design (LID) refers to stormwater management that prioritizes the use of distributed control facilities that are typically landscape-based tools to not only reduce stormwater pollution and volume on-site, but also to provide ancillary benefits of improved greenery, place-making, and other aesthetic and quality of life related improvements. LID is also referred to as Low-Impact Development, Green Stormwater Management, and a number of other terms; however, San Francisco has elected to use the term LID to highlight the role of stormwater management as an important part of good public space and building design.



**Design storm (Minor storm):** For separate sewer areas of San Francisco, the design storm is 0.75 inches of rainfall, which is the performance measure for semi-arid watersheds from the LEED Sustainable Sites Credit 6.2 titled “Stormwater Design: Quality Control.” For combined sewer areas, the goal is to manage 25% of the 2-year 24-hour storm, equivalent to LEED Sustainable Sites Credit 6.1 titled “Stormwater Design: Quantity Control.”

**Detention:** Stormwater runoff that is collected at one rate and then released at a lower rate. The difference is held in temporary storage.

**Filtration:** A treatment process that allows for removal of solid (particulate) matter from water by means of porous media such as sand, soil, or a man-made filter. Filtration is used to remove contaminants.

**Infiltration:** The process by which water penetrates into soil from the ground surface.

**Low Impact Design (LID):** An innovative stormwater management approach with a basic principle that is modeled after nature: manage rainfall at the source using decentralized facilities.

**Major storm event:** A rainfall event that is larger than the design storm. Although treatment facilities are not designed specifically to treat all the runoff from major storm events in the same capacity as a minor storm event, they should be designed to allow for the conveyance of larger flows without causing on-site flooding or erosion.

**Peak flow:** The point during a rainstorm where there is the highest volume of runoff in the city’s drainage system. Peak flow can be considered as the runoff ‘peak’ on a hydrograph.

**Permeability/Impermeability:** The quality of a soil or material that enables water or air to move through it, and thereby determines its suitability for infiltration-based stormwater strategies.

**Retention:** The reduction in total runoff that results when stormwater is diverted and allowed to infiltrate into the ground through existing or engineered soil systems.

**Runoff:** Water from rainfall that flows over the land surface that is not absorbed into the ground.

**Sedimentation:** The deposition and/or settling of particles suspended in water as a result of the slowing of the water.

## ➔ PLACEMENT

The stormwater management tools mentioned in this manual are highly customizable and can be integrated into a variety of different types of spaces in any of the street types. Opportunity sites include: corner and mid-block curb extensions, medians, pork chops, traffic circles and roundabouts, parking lane and sidewalk planters, streetscape plazas, roadway and park edges, the front building edge, street trees, and stand alone raised planters. They may be placed in the roadway on alleys with DPW approval.

Stormwater can also be used within landscaping or educational and art features. Designers of these facilities should look for opportunities to combine artistic elements, public art, and educational opportunities with stormwater management.

The following sections describe opportunities to place, construct, and retrofit systems to include stormwater management tools into both new and existing streets. Figure 6.5 describes typical applicability of specific stormwater tools to individual street types.



**FIGURE 6.5**  
**BEST FIT FOR**  
**STORMWATER**  
**FACILITIES BY**  
**STREET TYPE**

STREET TYPE		PAVING	BIORETENTION			CONVEYANCE		OTHER		
		Permeable Paving*	Rain Garden	Flow through and infiltration planter	Infiltration Boardwalks	Swales	Channels and Runnels	Infiltration and Soakage Trenches	Vegetated Buffer Strip	Vegetated Gutter
COMMERCIAL	Downtown Commercial	○	○				○	○		
	Commercial Throughway	○	○	○	○		○	○		
	Neighborhood Commercial	○	○	○	○		○	○		
RESIDENTIAL	Downtown Residential	○	○	○		○	○	○		○
	Residential Throughway	○	○	○		○	○	○		○
	Neighborhood Residential	○	○	○		○	○	○		○
INDUSTRIAL AND MIXED-USE	Industrial	○	○	○		○	○	○		
	Mixed-Use	○	○	○	○		○	○		
SPECIAL	Parkway	○	○	○		○	○	○	○	○
	Park Edge	○	○	○		○	○	○	○	○
	Multi-Way Boulevard	○	○	○		○	○	○	○	○
	Ceremonial (Civic)	○					○	○		
SMALL	Alley	○	○	○			○	○		
	Shared Public Way	○	○	○			○	○		
	Paseo	○	○	○	○		○	○		

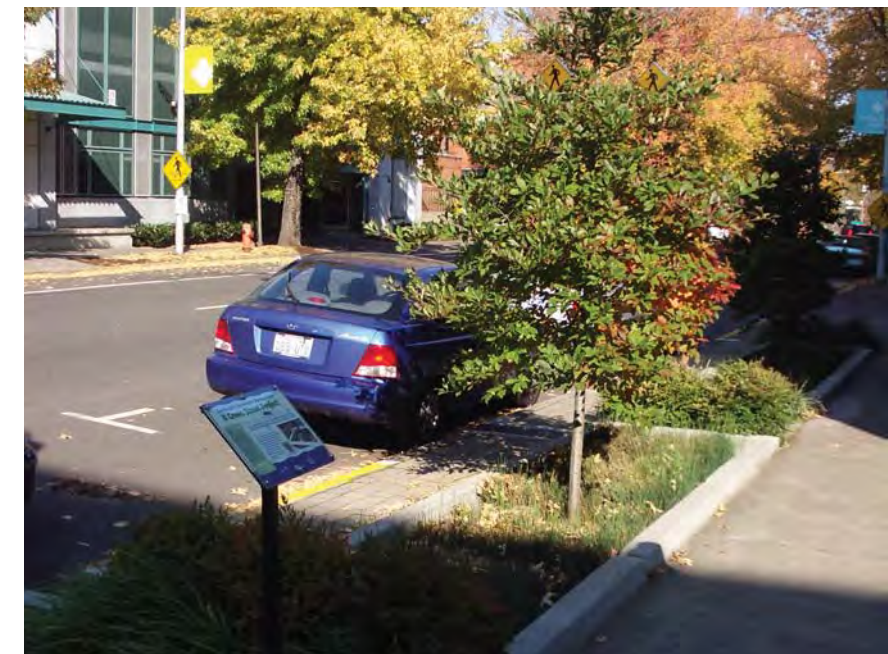


**FIGURE 6.6**  
**STORMWATER**  
**FACILITIES BY**  
**LOCATION IN**  
**THE RIGHT-OF-**  
**WAY**

PLACEMENT	PAVING	BIORETENTION			CONVEYANCE		OTHER		
	Permeable Paving*	Rain Garden	Flow through and infiltration planter	Infiltration Boardwalks	Swales	Channels and Runnels	Infiltration and Soakage Trenches	Vegetated Buffer Strip	Vegetated Gutter
Private Driveway or Yards	○	○	○	○	○	○ (covered)	○		
Sidewalk	○	○	○	○	○	○	○		
Curb Extension	○	○	○	○	○	○	○		
Parking Lane/Gutter	○	○	○		○	○ (covered)	○		○**
Bike Lane									
Through Lane									
Median	○	○*	○		○*	○	○*	○	
Traffic Circles	○	○*	○	○	○*	○*	○*		

\*Site conditions such as street grading may require special engineering; comply with DPW Director's Order on Permeable Paving

\*\* Best used in locations with few driveways or curb cuts



▲ Stormwater management tools are highly customizable and can be designed in ways that are appropriate to a wide variety of contexts



## GUIDELINES



- Areas not in the combined sewer system
- Port areas possibly not in the combined sewer system
- Port areas most likely not in the combined sewer system

- ▲ San Francisco's topography and geology limit the applicability of some tools in certain areas of the City, and in all cases define the applicability of some infiltration-based tools, size and design elements critical to a successful stormwater management tool. In combined sewer areas, water quantity is the primary concern; in separate sewer areas, water quality is the primary concern.

When integrating a stormwater treatment into a new or existing streetscape, designers should consider the objective of the installation. Where streetscape conditions allow, stormwater measures can be designed for conveyance, detention (peak rate control), retention (volume reduction), infiltration (groundwater recharge), and nutrient and sediment removal. (See Figure 6.4)

### Site Constraints

Streetscape geometry, topography, and climate determine the types of controls that can be implemented. The initial step in selecting a stormwater tool is determining the available open space and constraints. Although the size of a selected stormwater facility is typically controlled by the available area of opportunity, the standard design storm should be used to determine the appropriate size, slope, and materials of each facility.

After identifying the appropriate stormwater facilities for a site, an integrated approach using several stormwater tools is encouraged. To increase water quality and functional hydrologic benefits, several stormwater management tools can be used in succession—called a treatment train approach. The control measures should be designed using available topography to take advantage of gravity for conveyance to and/or through each facility. Concentrating too much runoff in one area should be avoided.

### Infiltration Considerations

Appropriate soils, infiltration media, and infiltration rates should be used for bioinfiltration and infiltration. A complete geotechnical report should be undertaken to determine infiltration rates, soil toxicity and stability, and other factors that will affect the ability and the desirability of infiltration.

Stormwater tools can be incorporated into areas of low permeability or where infiltration of stormwater is not desirable if special measures are undertaken. Underdrains should be used in areas where ponding is a concern. The location of the underdrain is an important consideration: if placed higher in a facility, the stored water below the perforated pipe will be infiltrated; if placed at the bottom of a sealed system, the perforated pipe will release the stored water slowly over time. All BMPs must have an approved overflow location for discharge. Approved locations are catch basins and outfalls.

Minor details can translate into the ultimate success or failure of a system. For example, poor soils may cause conditions in which plants will not survive or stormwater runoff ponds or infiltrates too fast. Over-compaction or smearing of subsurface soil during excavation can lead to reduced infiltration capacity and flooding. The bottom surface of infiltration areas should be level to allow even distribution and good permeability.

Catch basins may also be designed with water quality filters, catch basin hoods and litter guards to help enhance the treatment of rainfall runoff.



*Left:* Multi-purpose design of stormwater management tools stresses creating stormwater infrastructure that also improves public space.  
*Source:* EPA Office of Water

*Right:* Stormwater management can be a component of many other strategies elaborated in this plan, including remediating pork chop triangles.  
*Source:* Kevin Perry

## Landscaping

Landscaping should be chosen to fit the specific type of stormwater facility and should be appropriate for the local climate and soils. In general, all landscape-based stormwater facilities should be planted with drought-resistant and water-tolerant plantings that can survive periodic drought and inundation. Native, deep-rooted plantings or Mediterranean plants have been proven most effective. See the San Francisco Stormwater Design Guidelines Vegetation Palette for planting ideas.

Landscape features in stormwater facilities should follow the placement and clearance guidelines for understory plantings. See Section 6.1.

## Streetscape Considerations

### Utilities

Subsurface utility locations and building laterals should be factored into design considerations - access to utilities should be maintained. The presence of multiple driveways may also limit the ability to provide stormwater facilities. Where a high number of driveways or utilities reduces the ability to implement stormwater management tools on sidewalks, median locations for stormwater facilities should be considered.

### Accessibility

Standard requirements for sidewalk accessibility and clearances apply to planting areas and other stormwater facilities incorporated into the sidewalk. Specifically, stormwater facilities should follow these guidelines:

- Stormwater facilities that incorporate open planters, channels, or ditches should not be located in the through path of travel, at corners, or anywhere along the required accessible path
- Where stormwater facilities cross the path of travel, they should be covered by an ADA-compliant cover.
- Permeable paving systems in the path of travel should have no more than 1/4 inch gap between pavers

### → How Do Permeable Paving Systems Work?

- Pavers allow the surface to eliminate direct runoff by absorbing rainfall, letting water seep through the hard surface
- Water is temporarily stored in the subsurface volume of an aggregate layer that supports the pavement surface
- Water leaves the aggregate by either percolating into the ground (retention and infiltration) or by being drawn away through an underdrain if the subsoils are too saturated or impervious (detention).

- Where there is a vertical drop between sidewalks and stormwater facilities (such as bioretention facilities or channels), a 4 inch high lip should be provided at the edge of the facility for tactile detection.

### Transit Stops

Certain stormwater facilities, such as those that use open planters or channels, are not appropriate within transit stops, except in limited locations. However, this does not mean that there is no possibility for stormwater treatment at transit stops.

Appropriate strategies near transit stops include: building-adjacent planters, covered channels or runnels, and permeable paving. Any drainage feature within a transit waiting area should be covered by an ADA-compliant culvert, boardwalk, metal grate, or similar feature.

All strategies used should maintain a clear path of travel to shelters and boarding transit vehicles, per Section 5.5: Transit-Supportive Streetscape Design.

## Permeable Paving

Permeable paving, also called pervious paving, is an alternative to standard paving and can help reduce stormwater runoff volumes by reducing impervious surface and providing temporary storage and or groundwater recharge through infiltration. Absorbed water is temporarily stored in the rock base before being discharged through subdrains or infiltrating into the soil. Permeable paving can thereby decrease the cost of required on-site detention systems and downstream stormwater infrastructure upgrades due to the potential for stormwater runoff delay and volume reduction.

Permeable paving has also been shown to improve water quality by trapping pollutants such as sediments and oils within the underlying rock materials and by reducing the temperature of stormwater runoff before discharge to downstream systems. By draining water, they may also reduce puddling and slip hazards.

Permeable paving systems are typically surface paving systems that convey stormwater to an underlying uniformly graded aggregate base, where it is temporarily stored for either infiltration into subsoils or slow release to a storm drain system. Permeable paving surfaces can be divided into two general categories based on application:

- Common pervious pavement surfaces typically laid on open-graded angular drain rock include: permeable unit paver block systems with joint gaps, pervious asphalt, and pervious concrete.
- For light-weight limited use areas, such as plazas or emergency access roadways, pervious pavement surfaces typically laid on non-compacted soil include: plastic systems planted with grass, and stone or pre-cast concrete blocks backfilled with gravel or sand.

### → PLACEMENT

Permeable paving systems are most appropriate for pedestrian-only and low speed and vehicular traffic volume areas with minimal pollutant spill potential, groundwater contamination, or dust and debris accumulation (which will impair infiltration capacity). Permeable paving is well-



suited to seating and walking areas within the right-of-way, including the furnishings zone of most sidewalks, curb extensions, pocket parks, and the like. See Section 6.4: Paving, for appropriate locations for special paving.

Permeable paving may also be appropriate to parking lanes that are not also travel lanes or bus stops, and low-traffic and low-speed roadways, such as shared public ways, alleys, and non-arterial streets.

Although most permeable paving systems are at least as durable as typical concrete and asphalt, they are not suitable for high speed traffic or where heavy trucks are anticipated, on steep streets, or in contaminated areas. Particularly, use of permeable paving should be avoided:

- on traffic lanes on streets classified as arterials or collectors, concrete bus pads, or curbs
- On sloped areas or steep hillsides with slopes greater than 20%;
- in areas with a previous history of soil or shallow groundwater contamination;
- in gas stations, car washes, and automotive repair shops, or in areas where there is a possibility of chemical spills;
- on streets with a history of combined sewer overflows unless as part of a project aimed at eliminating such overflows;
- in areas with shallow groundwater or seasonal high groundwater (less than 10 feet) if receiving run-on (stormwater runoff from adjacent areas);
- within 20 feet of subsidewalk basements if receiving runoff; or
- within 50 feet of domestic water wells if receiving runoff.

See also the *Stormwater Design Guidelines* for contributing thresholds and the DPW *Director's Order #178,493 on Permeable Paving Systems*.

## GUIDELINES

### Design and Location

To minimize potential for failure or clogging, design of permeable paving systems should consider:

- suitability of the selected paving material for the site conditions;
- strength of underlying subgrade - subgrade should be constructed to support anticipated vehicular and pedestrian loads for the site;
- required depth and storage capacity of base course;
- surface and subsurface materials including filter fabrics; and
- installation method.

Permeable paving requires an understanding of the prior use of a site. Site tests should be performed to determine soil conditions including: percolation rate and infiltration capabilities, depth to seasonal high water table, depth to bedrock, and soil contamination.



Existing subgrade should be able to demonstrate a minimum permeability rate of 0.5 inches per hour. An underdrain may be used in soils with lower infiltration rate in order to obtain the minimum permeability rate. Percolation testing to identify the infiltration rate of the native soil will determine the depth of base rock for the storage of stormwater, and whether an underdrain system is necessary.

A separation of 4 feet above both the high water table and bedrock is required for proper performance. Permeable paving should not be installed over new or existing compacted fill.

Selected paving materials must be ADA-compliant, and not cause tripping hazards or excessive vibration. As with all paving materials, permeable unit pavers should leave gaps of no more than 1/4" inch wide, or up to 1/2" wide with beveled edges. Beveled edges should only be used to mitigate vertical change. Vertical changes should not exceed a slope of 1:2.

▼ *Left:* Some permeable systems allow stormwater to flow between pavers, as shown above. Others provide a solid surface without gaps, nearly indiscernible from traditional materials.

*Right:* Permeable pavers can be used in many areas of the streetscape, and add attractive variety to typical paving.  
Source: EPA Office of Water





Both permeable pavers and porous concrete have the added benefit of elimination of polycyclic aromatic hydrocarbons (PAHs) from the wastewater stream. Where porous asphalt is used, PAH-free asphalt alternatives should be considered as a source-control measure.

### Installation

Pervious pavement is most susceptible to failure during construction. Special staging and installation phasing measures should be taken to prevent compaction, sealing, or sediment build-up, including:

- Incorporate appropriate sediment reduction techniques wherever possible. Maintain erosion and sediment control measures until a site is stabilized.
- Remove all compacted sub-base and avoid compacting soils during construction
- Spread the infiltration over the largest area feasible. Avoid concentrating too much street runoff in one area. Most types of permeable pavement can receive run-on from adjacent areas: permeable asphalt and concrete should be at least 33 percent of the total drainage area, while permeable pavers should be at least 66 percent of the total drainage area
- Avoid smearing of underlying soil, to minimize sealing of soils.
- Avoid contamination with sediment; avoid tracking sediment onto pavement.
- Avoid drainage of sediment laden waters onto pervious surface or into stone sub-base constructed bed.
- Do not allow construction staging, soil/mulch storage, etc. on unprotected pavement surfaces.

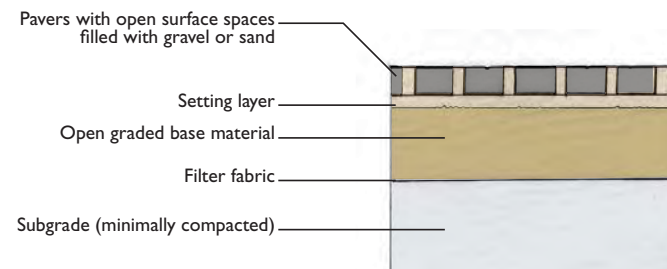
The bottom sub-grade should be graded level to allow even distribution of infiltration where soil conditions provide for permeability. Where provided, under-drains should be placed at the pavement edge to provide drainage that prevents pond formation in the base.

Any currently paved area can be retrofit with a permeable system; the existing compacted or otherwise impermeable subbase should be fully removed to prepare the soil for infiltration.

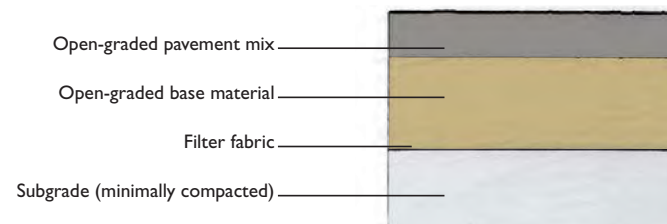
### MAINTENANCE

With proper maintenance, permeable paving materials have a proven durability of up to 30 or more years: an increased lifespan over asphalt. All permeable surfaces require routine street sweeping using vacuum sweepers every 6 months, tested annually for proper function, and have a scheduled vacuum removal of gap pea-stones and joint re-filling every 5 to 10 years.

#### Pervious Paver Systems



#### Pervious (Open Graded) Pavement and Asphalt Systems



Permeable paving can be used in driveways to help address stormwater and contribute to streetscape aesthetics with unique textures and materials

Alleys, shared public ways, and other low traffic volume streets are an appropriate application of permeable paving systems



Permeable paving is also appropriate in the parking lane  
Source: EPA Office of Water





## Bioretention

Bioretention facilities combine stormwater runoff control and treatment with aesthetic landscaping and architectural detail. These landscaped areas are used to collect, filter, and infiltrate runoff from roofs, streets, and sidewalks and are designed to incorporate many of the pollutant removal and infiltration functions that operate in natural ecosystems. This is achieved by filtering pollutants through soil particles (which trap pollutants) and vegetation (which take up pollutants) as the water percolates through the system. In addition to providing pollution reduction, bioretention facilities can be used to manage runoff flow rates and volumes, thus reducing the downstream potential for combined sewer overflows.

Bioretention systems can be designed as infiltration-based systems if the native soils beneath the facility are sufficiently permeable and there are no other constraints to infiltration such as soil or groundwater contamination. If infiltration is not feasible, they can be designed as flow-through systems that are contained within an impermeable liner and use an underdrain to direct treated runoff back to the collection system.

A note on terminology: bioretention facilities that are installed directly in the ground are typically called “rain

gardens”; those that are contained within a curb or hard-walled container are typically called “planters”

### ➔ PLACEMENT

Bioretention facilities can be integrated into all street types and may be placed in frontage or furnishings zones. They may be implemented in a variety of streetscape configurations including sidewalks, curb extensions, medians, pork chops, traffic circles and roundabouts, parking lane planters, and other geometries that create space for landscaping. They can be used to capture rooftop runoff from disconnected downspouts. Because they can be effective even in small installations, bioretention systems are appropriate in constrained locations where other stormwater facilities are not possible.

Infiltration-based bioretention facilities should only be considered in areas where native soils have a minimum permeability rate of 0.5 inches per hour and where the high water table and bedrock are at least 4 feet below the bottom of the facility. Flow-through systems with an underdrain may be used in soils with lower infiltration rates. These are particularly valuable as receiving bodies for roof runoff from downspouts when placed adjacent to buildings, because they include a waterproof lining which allows them to be incorporated into foundation walls. They may also be placed in the furnishings zone to receive runoff from the sidewalk and street (through curb breaks).

Infiltration-based bioretention facilities are best suited to sites that have less than a 5% slope. For slopes greater than 5%, they can incorporate check dams or other flow control devices to retard flow. Terraced flow-through planters can

be used on a variety of slopes.

### 🔍 GUIDELINES

Minimum planter width should be 2 to 3 feet to accommodate underdrain systems, allow for planting room, and allow for constructability. Bioretention systems should follow the landscaping clearances and guidelines for understory plantings in Section 6.1.

The use of several small facilities, rather than one large facility is preferable, as it provides a distributed infiltration area. The recommended ratio of impervious area to infiltration area is 5:1, depending on soil conditions.

The depressed area should contain a surface layer of organic mulch, underlain by an amended soil plant bed that supports virtually any combination of flood-tolerant turf, grasses, shrubs, and trees. Deep rooted water tolerant plantings are encouraged to improve filtration and nutrient control benefits.

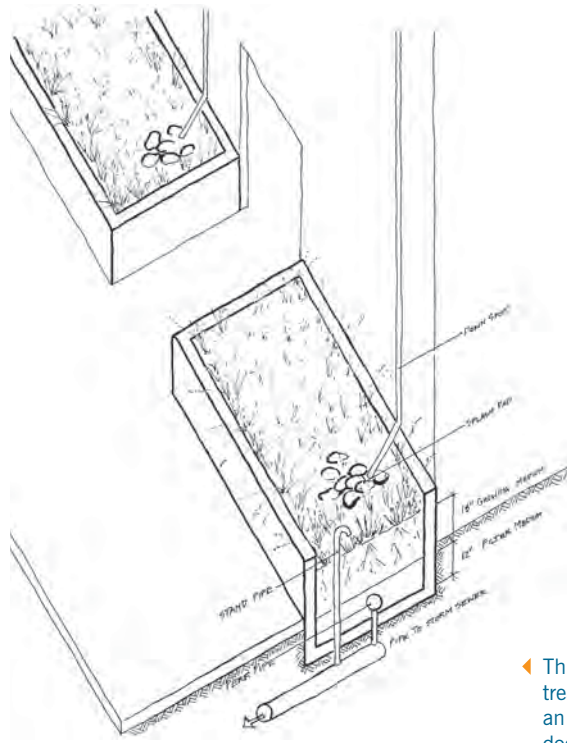
Bioretention features should be designed to drain stormwater within 48 hours after a rain event to avoid concerns about mosquitoes. Ponding depths should be limited to 6 inches or less for aesthetics, safety, and rapid draw down within that time frame. Certain situations may allow deeper ponding depths up to 9 inches, depending on location. Ponding depths increase during larger storms until runoff overflows an elevated weir or drain outlet for discharge to the city storm network. An overflow riser with a domed grate should be included for larger storm events.

Pre-treatment measures can help reduce the maintenance requirements of bioretention facilities and clogging of soils over time. Some pretreatment measures include: swales to filter out coarse sediments and debris or a pea gravel



◀ Stormwater planters can be part of the building frontage zone, where roof runoff is temporarily detained, and used as an amenity to add greenery to the streetscape





◀ This flow-through planter is designed to accept and treat roof runoff from the downspout, and includes an underdrain and an overflow pipe to ensure water does not compromise the building's structure.

border which acts to spread flow evenly and drop out larger particles.

An underdrain system should be considered where subsoil infiltration rates less than 0.5 inches/hour. A gravel trench with underdrain should be used to encourage drainage between rain events. If the system allows infiltration, it should be placed a minimum of 10 feet downgradient of 100 feet upgradient of building foundations. In some cases (outlined in the San Francisco Stormwater Design Guidelines), these distances may be reduced with SFPUC approval.

### Roadway-adjacent planters

Roadway runoff should be directed into bioretention fea-

tures by installing flush ribbon curbs on the street edge or small evenly-spaced curb cuts into the existing curb.

### Building-adjacent planters

Wherever building-adjacent planters are present, roof drains should direct water to these features first. Both underdrains and surface overflow drains are typically installed with building-adjacent planters. Building-adjacent planters should be designed to pond water for less than 48 hours after each storm.

Flow-through planters designed to detain roof runoff can be integrated into a building's foundation walls, and may be either raised or at grade. When raised, planters should be designed with 14 to 16 inch vertical heights to incorporate a seat wall.

Planters may be placed on either side of the property line to allow larger planting bodies to receive roof runoff. Planters should be structurally separate from the adjacent sidewalk to allow for future maintenance without disturbing the sidewalk. An expansion joint satisfies this requirement.

▼ Rain gardens can be part of medians, curb extensions, parks, plazas, and even typical streets. Source: Kevin Perry

▼ Rain gardens are highly customizable, and can be designed to fit into any number of spaces within the streetscape. This raingarden includes a channel, behind the pedestrian, to convey roadway runoff to the landscaped treatment area. Source: Kevin Perry

▼ Rain gardens may be placed in curb extensions on most street types





## Swales

Street swales are long narrow landscaped depressions primarily used to collect and convey stormwater and improve water quality. They remove sediment and reduce nutrient concentrations within runoff through natural treatment prior to discharge into another stormwater management facility or the sewer network. In addition to providing pollution reduction, swales also reduce runoff volumes and peak flow rates by detaining stormwater. Swales add significant landscaping to street corridors and reduce impervious surface. In some circumstances, rainwater infiltrates into the ground while being conveyed along the length of a swale.

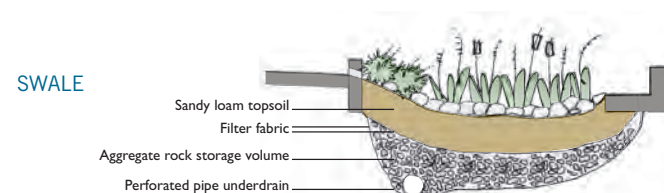
Several forms of swales exist and are highly customizable. Natural swales are depressed linear features that combine appropriate plantings with amended soils. Bioinfiltration swales (or bioretention swales) typically include a subsurface infiltration trench below amended soil.

### PLACEMENT

Swales are suitable for many street types with long, unconstrained areas, such as within medians or the outside edge of a street. Swales can be located in the furnishings zone of streets with unbroken curb edges, such as streets without parking lanes or many driveways. Frequent driveway curb cuts and sub-surface utilities may minimize the appropriateness of installing a swale.

Swales can be connected with other stormwater facilities such as rain gardens to provide pre-treatment. Similarly, on parkways and other streets with adjacent open space, natural swales are an excellent form of treatment and runoff delay prior to directing runoff to a larger stormwater management facility or the city sewer network.

Swales are appropriate for virtually all soil types, but proper routing and design require a full understanding of local soil topography and climatic conditions.



### GUIDELINES

#### Design

The preferred width for swales is 5 to 11 feet. Swales as narrow as 3 feet may be appropriate.

Swales should have shallow side slopes and depth to avoid safety risks and prevent erosion.

For swale slopes over 6%, check dams should be provided. Check dams should be constructed of durable, non-toxic materials such as rock, brick, concrete, or soil by integrating them into the grading of the swale.

Swales may be incorporated into the urban setting by incorporating hard vertical edges to create a formal edge or raised safety border.

Flush ribbon curbs on the street edge of a swale or evenly spaced small curb cuts into the existing raised curb should be used to allow roadway runoff to enter swales.

Amended topsoil should be installed to increase filtration and to improve infiltration and retention of runoff. With appropriately amended soils, a vegetated conveyance swale

▼ Swales can be used as landscape buffer  
Source: EPA Office of Water



can be combined with a subsurface infiltration trench. Where good infiltration rates exist, swales should be used in conjunction with subsurface infiltration trenches to further reduce both runoff volumes and peak discharge rates. In locations where there is low soil permeability, an underdrain should be considered.

Where swales are installed in medians, the adjacent roadway should be graded and crowned to drain toward the median swale to maximize runoff capture.

#### Landscaping

Filtration benefits of swales can be substantially improved by planting deep-rooted grasses and forbs and by minimizing the side slope.

Appropriately selected vegetation can improve infiltration functions, protect the swale from rain and wind erosion and enhance overall aesthetics. Selected species should not require irrigation after establishment.

Swales should follow landscaping clearances and guidelines for understory plantings. See Section 6.1.

▼ This parking lot swale at Sunset Circle on Lake Merced accepts and treats runoff from the parking lot



## Vegetated Gutters

Vegetated gutters, also known as green gutters, are narrow landscape systems along street frontages that capture and slow stormwater flow. Typically less than three feet wide, green gutters most resemble planters in that they are confined by vertical curbs and have a flat-bottom profile. Unlike typical planters, however, green gutters are designed to be very shallow with little or no water retention. While infiltration of stormwater is a possibility, the primary purpose of using green gutters is to provide a site design measure using strip of landscaping to help filter out pollutants and slow the flow of water. Vegetated gutters can be an inexpensive way to add greening and stormwater treatment without moving curbs.

### ➔ PLACEMENT

Vegetated gutters are appropriate on streets with extra right-of-way width that can accommodate a narrow landscaped strip, and informal conditions such as residential or green streets.

Vegetated gutters are most appropriate to streets with no on-street parking lanes and infrequent driveways, though they may be used on other streets as well.

### 🕒 GUIDELINES

Vegetated gutters have a flat base to filter pollutants and hold stormwater runoff. Where appropriate, they can be designed to infiltrate stormwater. Because they are typically narrow in width, they must be very long to adequately filter and slow stormwater.

Vegetated gutters are typically shallow, allowing no more than 3 inches of runoff to pond at one time. Since they would have a drop-off from the sidewalk, a 4 inch lip should be provided around the feature.

Where designed on streets with on-street parking and driveways, an edge zone and pass-throughs to the sidewalk from the parking lane must be provided per Section 4.2, which would break up the continuity of the stormwater facility.

## Vegetated Buffer Strip

Vegetated buffer strips are sloping planted areas designed to treat and infiltrate sheet flow from adjacent impervious surfaces. They slope away from the impervious surface and are most often planted with grass, though other uniformly distributed plant species are also appropriate. Buffer strips function by slowing stormwater runoff and allowing sediment and other pollutants to settle and infiltrate.

### ➔ PLACEMENT

Vegetated buffer strips are well-suited to treating runoff from roads and highways, roof downspouts, small parking lots, and pervious surfaces. They are also appropriate for the “outer zone” of a stream buffer. They may be commonly used on multi-way boulevards, park edge streets, or parkways with significant medians.

### 🕒 GUIDELINES

Vegetated buffers strips should be designed as attractive features that tend to be viewed as landscape amenities rather than as stormwater infrastructure. The vegetative surface

should extend across the full width of the area being drained. The thicker and more uniform the plant cover, the greater the stormwater management benefits.

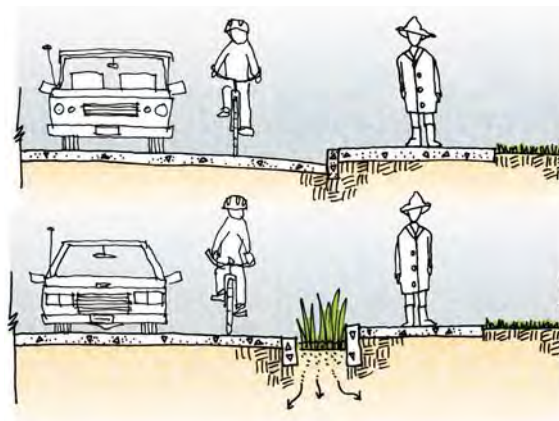
Because buffer strips cannot treat large amounts of runoff, the maximum drainage width (with the direction of flow being towards the buffer) of the contributing drainage area should be 60 feet. In general, a buffer strip should be at least 15 feet wide in the direction of flow to provide water quality treatment.

The top of the strip should be set 2 to 5 inches below the adjacent pavement or contributing drainage area, so that vegetation and sediment accumulation at the edge of the strip does not prevent runoff from entering.

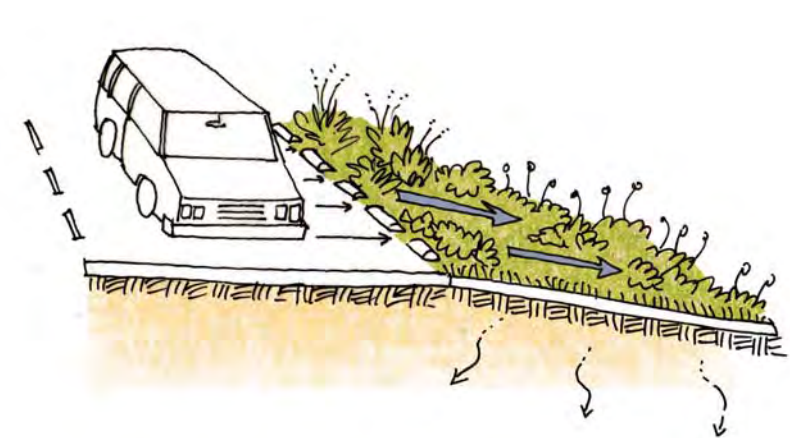
Buffer strips should be sited on gentle slopes between 1 and 15%. Steeper slopes may trigger erosion during heavy rain events, thus eliminating water quality benefits.

Vegetated buffers can be situated so they serve as pre-treatment for another stormwater facility.

▼ Vegetated gutter

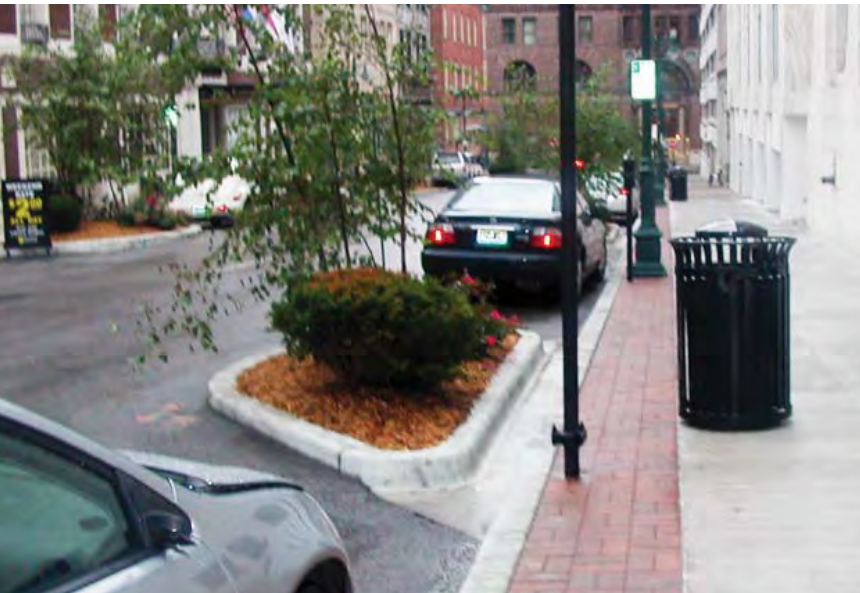


▼ Vegetated buffer strip





## Channels and Runnels



Channels and runnels are concrete or stone lined pathways used to convey rainwater runoff along the surface to other stormwater control measures or the city collection system. Runnels are shallow systems usually designed for small spaces and conveyance of small to moderate flows, while larger and deeper channels are used for collection and conveyance of moderate to large flows.

Channels and runnels reduce the need for buried storm drains and convey surface water where subsurface utility infrastructure prohibits the installation of additional storm drain piping. They can add aesthetic, artistic, and educational features to a design by highlighting rainfall rather than quickly directing runoff to an underground piped system.

### ➔ PLACEMENT

Channels and runnels are suitable for most street types and open spaces. They can be incorporated as an aesthetic design element along sidewalk planting areas or within central medians.

In curb extension construction, moving storm drain inlets can often be cost prohibitive. Channeling stormwater through a covered trench drain in the curb extension can allow the existing drainage infrastructure to remain, which may provide capital cost savings in some cases. See “Trench Drains” below and in Section 5.3: Curb Extensions.

### 🔧 GUIDELINES

Channels and Runnels can be designed with a wide range of materials such as unit pavers, bricks, recycled cobblestone, flat river rock, concrete, colored concrete, steel plate edging, or any durable impermeable material. They should be concrete mortared in highly urban areas for durability.

Where pedestrian crossing or accessibility is required, channels or runnels should be covered with decorative or durable linear trench drain grates, boardwalks, or other

ADA-compliant walkable surface at least 4 feet in width. The bottom of the covered channel should be maintained at or below the grade of pre-existing gutter pan to preserve drainage to the storm drain inlet.

### Runnels

Runnels are usually designed as an integrated element within street or plaza hardscapes. They should be located so as to minimize crossing of designated ADA pathways or emergency egresses. Where they do cross, a cover as described below (under Trench Drains) should be incorporated into the design.

Typical runnels range from 10 to 36 inches wide and use contrasting material for aesthetic effect and improved differentiation by people with visual impairments.

Runnels should be designed with a smooth sloping cross section with depths not exceeding 2 to 2-1/2 inches for safety. Runnels should have a gentle slope of between 0.5% and 3% toward the outlet or discharge point.

On low volume streets such as alleys, runnels can be combined with soakage trenches in the center of the roadway to drain runoff by infiltration through the roadway center. This requires grading and crowning toward the center of the street.

### Channels

Channels can also be integrated within street or plaza hardscapes for the collection of several small drainage areas. Under most circumstances, channels should have vertical hard sides with hard or natural bottom flow paths. Channels are usually deeper than 6 inches. They should be set back a minimum of 2 feet from the sidewalk or curb.

Where an uncovered change of level is present within sidewalk or plaza areas, a 4 inch raised curb or border should be incorporated into the design to provide physical separation.



▲ Channels and runnels direct water through hardscape features to other stormwater management facilities



Channels should maintain a minimum slope of at least 0.5%, and the maximum slope in the absence of structural controls should not exceed 6%. Where steeper slopes are present, terraces or check dams should be incorporated into the channel design.

### Covered Runnels or Channels (Trench Drains)

Where channels or runnels cross a pedestrian path of travel, a smooth ADA compliant cover, such as a steel grate or boardwalk, should be part of the design: this configuration is referred to as a covered channel, or trench drain. They may be used on new streets or retrofits to existing streets, at curb extensions, raised crossings, stormwater facilities, curbside streets (shared or pedestrian-only), or other places where drainage channels are necessary outside of the standard curb and gutter. This treatment may be considered as a potential cost reduction strategy in locations where curb extensions are implemented to allow pre-existing catch basin location to be maintained. They should be used anywhere a channel or runnel crosses a pedestrian path, such as within transit stops.

In many cases, trench drains may be a cost-effective and desirable solution to solve complicated drainage configurations. However, if not properly located and designed, they may present issues with drainage, maintenance, and accessibility.

#### Guidelines

Trench drains must be designed to carry the 5-year design storm event within the drain and be able to carry excess storm flow to the downstream inlet. Trench drains must maintain standard cross-slope of 2% on the sidewalk for positive drainage. In case of larger storm events or a stopped trench drain, the drainage profile of the site should be designed to drain to nearest gutter or other drainage feature, and away from adjacent properties.

Trench grates should be a minimum of 8 inches in width to allow debris to move through the drain and not severely limit the drainage capacity of the drain should debris build up.

Attractive grates should be used to provide an interesting urban design accent. They should be designed to integrate their visual appearance with the overall streetscape design.

Grates or other access panels covering trench drains through curb extensions must be designed, installed and maintained so as not to pose an obstacle or tripping hazard.

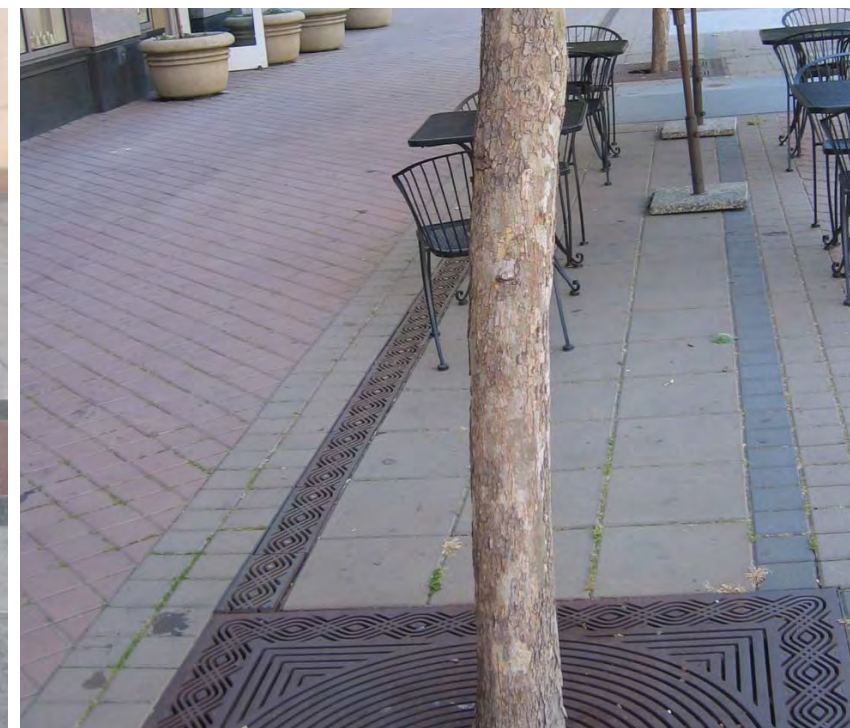
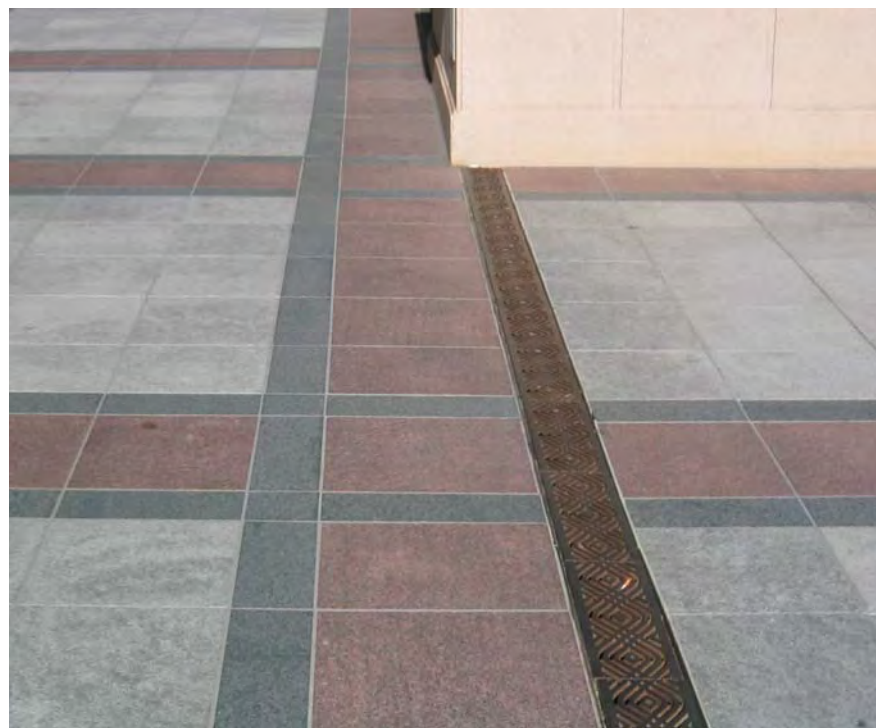
Due to the potential for increased maintenance burdens with the use of trench drains, a maintenance plan or agreement with private sponsor should be in place prior to their installation.

## Infiltration Trenches

Infiltration trenches are shallow subsurface linear stormwater facilities. They are typically 2 to 5 feet deep and installed in relatively permeable soils to provide on-site stormwater retention by collecting and recharging stormwater runoff into the ground. Trenches are typically backfilled with sand or coarse drain rock, and lined with filter fabric. The trench surface can be planted, covered with grating, covered with boardwalks, or consist of exposed drain rock or sand.

Depending upon the design, trenches allow for the partial or total infiltration of stormwater runoff into the underlying soil to reduce stormwater runoff volume. During small storm events, volume reduction may be significant and there may be little or no discharge. During large storm events, un-retained overflow should be provided by a gravity outlet.

▼ Trench drains (covered channels) can use attractive grates and can be integrated with other site design elements.







▲ This attractive architectural planter and fountain is a disconnected downspout that drains to a planter with an infiltration trench below

Infiltration trenches can be effectively integrated into most of the other stormwater facilities described in this section to enhance the function and stormwater mitigation capability of the other facility.

The selection and use of infiltration trenches is highly dependent on soil type and height of the groundwater table. Temporary storage capacity of the system can be increased by installing multiple perforated pipes into a wide infiltration bed system.

Infiltration trenches are highly customizable with relatively low maintenance and can be incorporated with other stormwater tools. They reduce runoff volumes and rates through groundwater recharge and increase water quality by filtering pollutants and sediments. Because of their narrow linear size, infiltration trenches can be installed as new or easily retrofitted into sidewalk areas or medians when not constrained by utilities.

### ➔ PLACEMENT

Infiltration trenches are typically linear systems that can be located under sidewalks or medians, within sidewalk planting strips, beneath curb extensions, and in some circumstances beneath parking lanes. Within medians, they are most effective when the street is graded and crowned to drain to the median.

Infiltration trenches should be sited on uncompacted soils with acceptable infiltration capacity. They are best used where soil and topography allow for moderate to good infiltration rates.

Infiltration trenches can be designed as a stand alone system or combined and integrated with other stormwater facilities such as swales, bioretention features, or permeable paving, or as a downstream retention system at the discharge end of most other stormwater management tools.

### ↶ GUIDELINES

Infiltration trenches should be designed to minimize potential failure or clogging. The major components to consider during design include the use of a pre-treatment water quality inlet or sediment basin, adequate system piping, non-clogging filter fabric, clean and uniform aggregate drain rock, proper trench preparation, and adequate structure design for release.

#### Pre-treatment Structure

It is critical to design for stormwater runoff pre-treatment prior to directing raw runoff into a closed infiltration trench or gallery. A pre-treatment structure is designed to receive street runoff prior to discharging to the infiltration or soakage trench to minimize the entry of sediments and other debris into the system.

A water quality inlet with a minimum 18 inch sump is recommended for all surface drain inlets prior to discharge to a surface stormwater facility or subsurface underdrain system. The inlet should be installed between the influent conveyance pipe and infiltration trench with perforated distribution pipe system. The infiltration trench should be installed a minimum of 5 to 10 feet from a building depending on whether a below grade dwelling space exists.

As an alternative, a small depressed natural sedimentation basin should be incorporated into the influent end of any stormwater facility to minimize long-term clogging.

#### System Piping

The facility piping consists of 3 parts: an inlet pipe located between the sediment basin and the infiltration trench (or downspout or area drain), a perforated dispersion pipe located in the aggregate bed of the infiltration trench, and an outlet overflow pipe.

The inlet piping should be raised such that sediments in the pre-treatment structure remain trapped and do not transfer to the infiltration system.

Within the infiltration system, a continuously perforated pipe should extend the length of the trench and have a positive flow connection designed to allow high flows to be conveyed through the infiltration trench.

Based on soil type and intended system function, adjustment to the perforated pipe elevation within the drain rock trench should be considered. For well draining soils, install the pipe near the top of the clean aggregate base to maximize infiltration. For moderate draining soils, install the pipe near the bottom of the clean aggregate base to minimize infiltration while still attenuating runoff through temporary storage.

Cleanouts or inlets should be installed at both ends of the infiltration trench and at appropriate intervals to allow access to the perforated pipe. Monitoring wells are recommended (and can be combined with clean-out). The discharge or overflow from the infiltration trench should be properly designed for anticipated flows.

### Trench

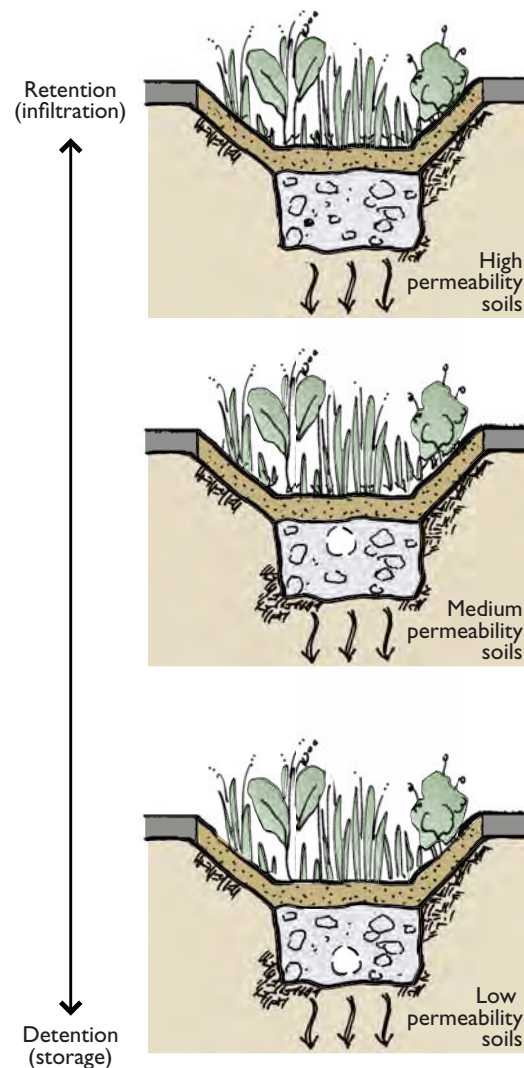
The slope of the infiltration trench bottom should be designed to be level or with a maximum slope of 1%. A level bottom assures even water distribution and infiltration. The trench and perforated pipe should be installed parallel to the contour of the finished grade. If moderate ground slope exists, the trench may be constructed as a series of steps or with clay check dams if necessary.

### Installation

Prior to design of any retention or infiltration system, proper soil investigation and percolation testing should be conducted to determine appropriate infiltration design rates. During the site layout of the facility there should be no less than 3 feet of undisturbed depth of infiltration

medium between the bottom of the facility and any impervious layer (hardpan, solid rock, etc.) or seasonal high groundwater levels (for water quality protection).

Infiltration trenches should be installed parallel to the contour with maximum ground slopes of 20% and be located no closer than 5 feet to any building structure. Compaction of soils should be avoided during construction.



▲ Infiltration trenches can be located beneath other stormwater management tools, such as permeable paving or landscaped facilities, to increase storage capacity for infiltration





## Infiltration Boardwalks



▲ This apartment building uses boardwalks over an infiltration area to define unique entrances to each unit from a shared public way  
Source: Sherwood Design Engineers

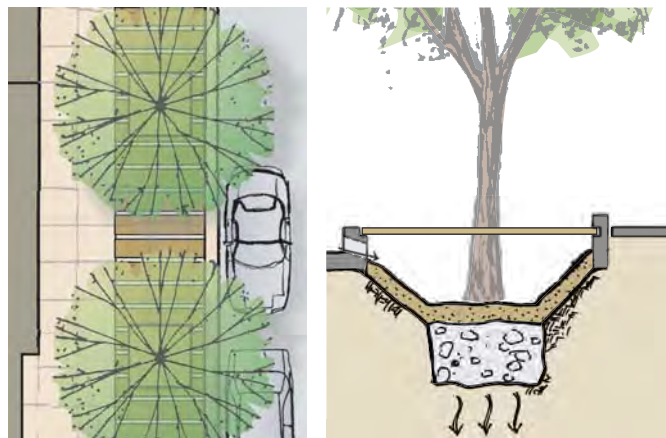


▲ Pathways across pocket parks and other large open space areas in the right-of-way can be raised to allow infiltration below  
Source: Sherwood Design Engineers

As an alternative to exposed landscape stormwater facilities, segments of sidewalks or reconstructed curb extensions may be retrofitted with durable boardwalks to serve as clear pedestrian thoroughways integrated with stormwater management. Raised boardwalks may be placed over exposed drainage rock or amended engineered soils to allow stormwater to pass beneath a walking surface for temporary storage or infiltration into the soils below.

A boardwalk creates an exposed soil or gravel infiltration trench beneath the sidewalk that effectively reduces impervious surface area and provide opportunities to clean and infiltrate runoff from the public right-of-way, without losing valuable pedestrian space.

Boardwalks can add interesting diversity of color, texture and material to the sidewalk and create possibilities for landscaping or educational uses.



▲ *Left:* Boardwalks may be used as a sidewalk treatment in the furnishings zone, or on curb extensions.

*Right:* An infiltration trench below the boardwalk would allow roadway runoff to be detained and treated and potentially infiltrated. Infiltration basins can alternate with tree basins beneath the boardwalk to preserve street tree planting, or structural soils can be used to serve as both an infiltration and tree planting medium.

### ➔ PLACEMENT

Boardwalks are best suited for flat streets.

Infiltration boardwalks should be used in the furnishings or extension zones, outside of corners and other crossing areas. The thoroughway and frontage zones are not appropriate for this treatment.

Infiltration boardwalks are not recommended adjacent to curbs that serve as transit stops.

### 🕒 GUIDELINES


Boardwalks may continuously cover infiltration areas or sections of boardwalk can be removed and infiltration areas may be planted with rushes or grasses, resulting in a bioretention facility.

Boardwalks should be flush with existing sidewalk level and covered with an ADA-compliant walkable surface to reduce tripping hazards and maintain a sense of one continuous pedestrian realm. Boardwalks should have accessible surfaces with gaps of no more than 1/4 inch. They may use a distinct paving material from the rest of the sidewalk. (See Section 6.4.)

Similar to bioretention facilities, facilities placed in series would allow overflow from one infiltration area to be captured by the following during larger rain events, with an ultimate outflow to the nearest stormsewer system inlet.

A pre-treatment forebay should be located between each curb cut or channel entrance and the below grade infiltration system to collect street debris and allow particulates to settle out to minimize maintenance. When planting is not desired under boardwalk sections, the top surface should be designed with drain rock.

Sign poles, utility access panels, and pedestrian amenities may all be maintained within the boardwalk area with appropriate clearances (See Site Furnishings, Section 6.5).

The background of the page is a dark, monochromatic image showing the silhouettes of several ornate street lamps. The lamps have rounded, lantern-like shades and decorative finials. They are arranged in a way that creates a sense of depth and perspective, with some appearing closer and larger than others. The overall mood is quiet and urban.

Street lighting is a key organizing streetscape element that defines the nighttime visual environment in urban settings. Street lighting includes roadway and pedestrian lighting in the public right-of-way.



# Lighting

## 6.3

Street lighting is a key organizing streetscape element that defines the nighttime visual environment in urban settings. Street lighting includes roadway and pedestrian lighting in the public right-of-way.

Quality street lighting helps define a positive urban character and supports nighttime activities. The quality of visual information is critical for both traffic safety and pedestrian safety and security. Lighting should be designed not only for vehicular traffic on the roadways, but also for pedestrians on sidewalks and pedestrian paths.

### ➔ PLACEMENT

Pedestrian lighting should be prioritized in the following locations:

- ➔ streets with high pedestrian volumes;
- ➔ key civic, downtown, and commercial streets;
- ➔ streets with concerns about pedestrian safety and security, such as at freeway underpasses; and
- ➔ small streets such as alleys and pedestrian pathways.



**GUIDELINES**

**Location and Spacing**

Street lighting poles should be located on the sidewalk close to the curb on the curb side edge, or centered within, the furnishing zone. Typically, pedestrian lighting poles align with the street lighting poles. However, on very wide sidewalks pedestrian lighting poles may be farther from the curb than the street lighting poles to light the primary walkway.

**Relation to other streetscape elements:** Pedestrian lighting should be added to street light poles where feasible unless spacing between street light poles does not support adequate pedestrian lighting, in which case pedestrian lighting may need to be located between street light poles. Light poles should be coordinated with other streetscape elements. Utility equipment above and below ground, such as pull boxes and underground trenches, should be coordinated when locating lighting fixtures.

Light fixtures should not be located next to tree canopies that may block the light. When determining tree type, anticipated height and diameter of the tree canopy should be considered relative to lighting fixture height and spacing based on light level and uniformity requirements. Appropriate distance between the tree and light fixture depends upon the type of tree and type of light fixture. If blocking the light output of the fixture cannot be avoided due to existing locations of the light fixture and trees, consider adding additional light fixtures to mitigate the shadows from the tree canopy.

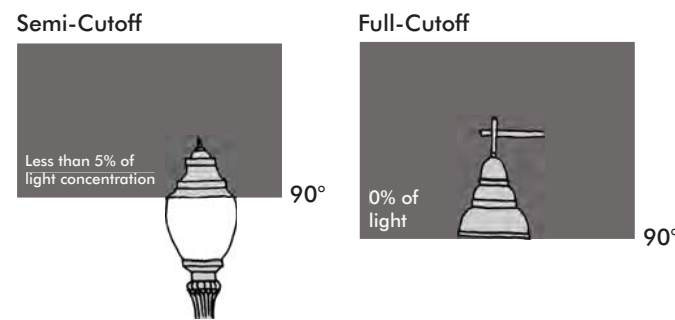
**Light Distribution**

Light fixtures should be selected to efficiently direct light to the desired area of the roadway and sidewalk. Light fixtures should enable a variety of light distributions to adapt to different street and sidewalk configurations while maintaining the same fixture appearance. The distribution type should be selected based on street and sidewalk width.

Glare should be mitigated by selecting the proper lamp wattage and mounting fixtures at the appropriate height.

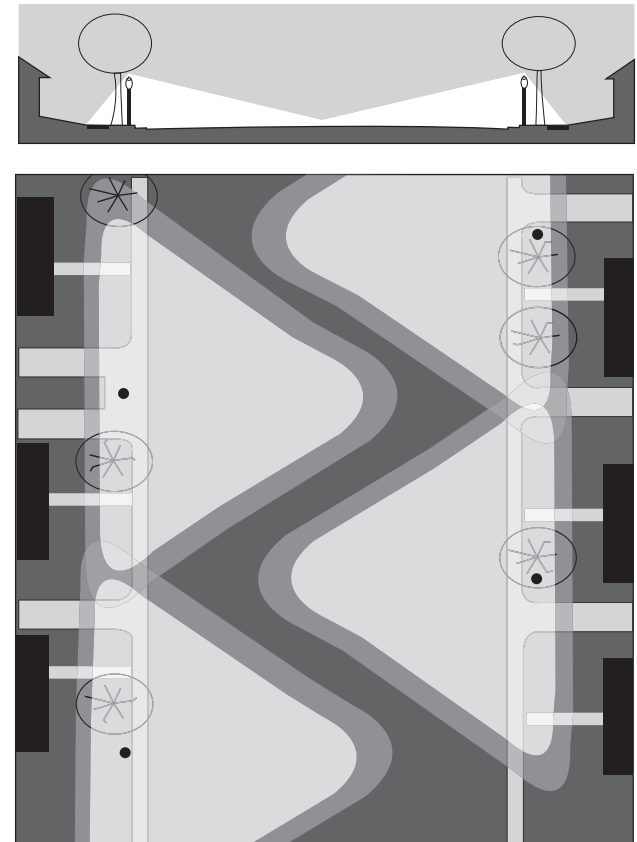
Sky glow is a consequence of several components of lighting: light directed to the sky from fixtures and light reflected off the ground. Light trespass is light that enters an area where it is not wanted, such as street light entering a residential property. Both sky glow and light trespass can be irritating and detrimental to the environment.

Sky glow should be mitigated by selecting dark sky friendly lighting fixtures that direct most of the light downward, by eliminating excessive light level, and turning lights off when not needed. New and replacement light fixtures should achieve a semi-cutoff light (5% or less concentration of light above a 90 degree angle from the fixture than the light output of the fixture), with a target of full-cutoff (zero light loss above the fixture or shield level). Existing fixtures should be retrofit or replaced to meet these targets as funding allows. Exceptions may be considered, such as for historical lighting or where up-lighting is desirable for security purposes.



Light trespass should be mitigated by specifying the correct light distribution. Lighting fixtures should not be located close to windows to avoid light trespass or glare and disturb the adjacent building's occupants. If necessary, house-side shields may be used on fixtures to minimize light trespass into residences or other areas.

Street lighting should strive for an even distribution of light along the street



Pedestrian scale lighting fixtures better light the pedestrian way, providing an improved sense of security and comfort





### Light Color

The color of the nighttime environment is dependant upon the light source. LED (light-emitting diode), metal halide, induction, and fluorescent lamps create a relatively white light compared to the yellow of high-pressure sodium lamps. Color identification is easier and clearer under white light sources. There is also emerging data that peripheral vision is improved with white light sources.

Traditionally, high-pressure sodium lamps have been used throughout the City for their long life and energy efficiency. However, as improved technologies have emerged, the SFPUC is now replacing high-pressure sodium lamps with LED lamps. White light sources are currently used in some areas and may be used in future development where more accurate color identification is desired or for areas that need color differentiation. In pedestrian areas (sidewalks and crosswalks), lamp technology that produces a blue or white spectrum light should be used.

New and replacement lamps should aim for a color temperature between 4,500 and 5,500. Existing lamps should be retrofit to meet the above target as funding allows.

### Light Poles and Fixtures

Street lighting fixtures illuminate both roadway and sidewalk and are typically 20 to 30 feet high. Typically, the taller the pole height, the larger the area each lighting fixture can illuminate. This means that the spacing between lighting fixtures can be wider and fewer fixtures can be used to light the street, which is economical for construction and maintenance.

Pedestrian-scale lighting fixtures, typically 12 to 15 feet high, illuminate pedestrian-only walkways and provide supplemental light for the sidewalk. Pedestrian-scale fixtures should be encouraged to improve pedestrian lighting on key streets, and considered in areas with high nighttime pedestrian activity and/or wide sidewalks. They should also be considered for narrow streets, including local access lanes, alleys, shared public ways, and pedestrian pathways, that can be adequately illuminated with these fixtures alone. In these situations, street lighting fixtures will most likely be required at intersections, at mid-block crosswalks, and on the through-lanes of multi-way boulevards.

The city should explore opportunities to encourage property owners, private developers, and public buildings to

install wall mounted or suspended pedestrian lighting fixtures for sidewalks, alleys, shared public ways, or pedestrian-only streets where conditions allow.

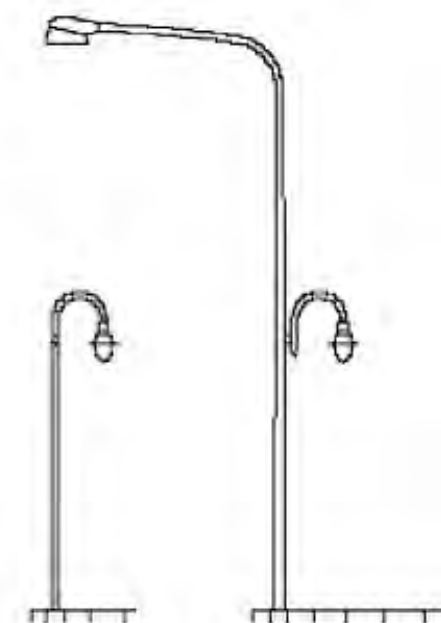
Light fixtures should be selected that are appropriate to the overall streetscape style and identity of the neighborhood and that maintain continuity between the different streets in the neighborhood. Neighborhoods should have a consistent fixture style to present a unified appearance, and similar neighborhoods around the City should have the same or similar fixture styles. Accessories such as banner arms may be added to light poles to further identify the neighborhood. Historic light standards (for example, the Path of Gold (Market Street)) lights should be preserved, and restored according to the Secretary of the Interior's Standards as funding allows.

To create a unified palette of fixtures throughout the City, with managed flexibility for unique neighborhood improvements, a coordinated street light master plan should be undertaken to develop standards for appropriate fixtures and more detailed location and technical criteria.



◀ Downward-facing lighting prevents excess light from trespassing into adjacent buildings

▶ Pedestrian lighting should share poles with street lights wherever possible to minimize streetscape clutter. However, light level and uniformity requirements should take precedence over pole consolidation.



By day, the style of a light fixture has significant impact on the character of a neighborhood. By night, the light distribution of a fixture will define the visual environment and the fixture itself may be a design element in the streetscape. Both day and night characteristics of a light fixture should be considered when selecting appropriate fixtures for a neighborhood.

Light fixtures with an opaque top, no glowing lens (without features to make the fixture dark sky friendly), and an optical system that directs all light downward, such as a flat lens “cobra head,” present a low profile at night and direct attention to other elements in the streetscape. This type of light fixture should be prioritized on residential and small streets.

Fixtures that have a glowing lens such as a “teardrop” or “acorn” will be a visible element and a prominent part of the streetscape at night. There are decorative and historic advantages to using a lighting fixture with a glowing lens, but the fixture should be dark sky friendly and direct most of the light downward. This type of light fixture should be prioritized on civic or commercial streets.

Light fixture elements such as the pole and lamp should be proportional to each other, and their scale should be balanced with the surrounding building and roadway context.

The rhythm of the light poles should be consistent in a given neighborhood. On wide streets, light fixtures should be located on both sides of the street, and can be staggered or parallel depending upon light level and uniformity considerations. Light poles should have a consistent spacing with regard to trees and other street poles.

Where possible, street lighting should be combined with traffic light or Muni poles to reduce the quantity of poles on the sidewalk. However, light level and uniformity requirements should take priority over pole consolidation. In cases where attaching pedestrian lighting to existing roadway lighting fixtures still does not provide adequate pedestrian lighting, pedestrian lighting fixtures may need to be added between roadway lighting poles.

### Energy Efficiency

Energy efficient lamps produce a higher light output per watt than non-energy efficient lamps. In addition to the lamps, energy efficient fixture designs should be specified. A good optical system directs light to where it is needed and optimizes light output. Fixtures that direct light primarily downward toward the street rather than up toward the sky should be selected. New or replacement pedestrian and street lighting should aim to be a minimum of 50% more energy efficient than standard high pressure sodium fixtures. New or replacement pedestrian and street lighting should aim for a measurable efficiency of 70-115 lumens/watt, the efficiency level of current high-pressure sodium lights.

For further energy savings, the City may select to turn off certain lights later in the evening. For example, when pedestrian lighting is used to supplement street lighting to support high nighttime pedestrian activity, the pedestrian lighting may be turned off when pedestrian activity decreases late at night.

The City’s approved palette of light fixtures should be evaluated and updated to be compatible with the “smart controller technology system” to be managed by the SFPUC.

### Light Levels and Uniformity

The City currently does not have set standards for pedestrian light levels. As part of a future street lighting master plan, the City should create such standards. Preliminary targets for pedestrian light levels for each Better Streets Plan type are shown in Figure 6.9. These levels refer to **light directed on pedestrian zones** such as sidewalks, shared public ways, public stairways, and other pedestrian paths. Light levels are measured in foot candles (fc), which are approximately the distance (in feet) that is illuminated away from the source of light, measured in lumens per foot.

Pedestrian lighting should be provided on high pedestrian volume corridors or where a special design treatment is desired to supplement roadway lighting. Pedestrian lighting should be consistent throughout a block and minimize variance between bright and dark areas.

FIGURE 6.7  
ROADWAY LIGHT LEVELS

STREETScape TYPE	Horizontal light level range <sup>1,2</sup> at ground Minimum maintained average <sup>3</sup>	Uniformity ratio range <sup>1,2</sup> Average/Minimum
Downtown Commercial	Defer to Downtown Streetscape Plan	Defer to Downtown Streetscape Plan
Downtown Residential, Neighborhood Commercial (IESNA Roadway classifications: Major/Collector/Local)	0.5 to 1.7	3 to 6
Commercial Thoroughway (IESNA Roadway classifications: Major/Collector)	0.6 to 1.7	3 to 6
Neighborhood Residential (IESNA Roadway classifications: Collector/Local)	0.4 to 1.2	4 to 6
Residential Thoroughway (IESNA Roadway classifications: Major/Collector/Expressway)	0.4 to 1.2	3 to 4
Industrial Multi-way Boulevard <sup>4</sup> (IESNA Roadway classifications: Major/Collector/Local/Expressway)	0.4 to 1.7	3 to 6
Mixed-Use Parkway Park Edge (IESNA Roadway classifications: Major/Collector/Local)	0.4 to 1.7	3 to 6
Ceremonial (Civic)	Defer to potential subsequent design plan	Defer to potential subsequent design plan
Alleys, Shared Public Ways (IESNA Roadway classifications: Alley)	0.4 to 0.5	4 to 6
Paseos (IESNA classification: Pedestrian walkway)	0.4 to 1	4 to 6

1 Requirements in RP-8 are periodically revised and updated. Latest edition should be used for determining the light level and uniformity ratio requirements.

2 A range of light levels are listed. The exact minimum maintained average light level depends upon traffic and pedestrian volume and pavement classification (related to pavement reflection of light) for any given street. These variables must be verified for each street to determine exact minimum maintained average value. Verify technical classifications with the City for both roadway and pedestrian paths for individual streets.

3 Minimum maintained average is the lowest accepted value of an average light level calculated with a light loss factor.

4 A Multi-way Boulevard may have different roadway classifications for the thoroughway portion and the local access lanes of the boulevard. Local access lane lighting requirements will vary with adjacent land use context. Verify technical classification with the City for each street.



**FIGURE 6.8**  
**INTERSECTION/CROSSWALK LIGHT LEVELS**

FUNCTIONAL CLASSIFICATION	AVERAGE MAINTAINED ILLUMINATION AT PAVEMENT BY PEDESTRIAN AREA CLASSIFICATION (LUX/FC)		
	HIGH	MEDIUM	LOW
Major/Major	3.4fc	2.6 fc	1.8 fc
Major/Collector	2.9fc	2.2 fc	1.5 fc
Major/Local	2.6 fc	2.0 fc	1.3 fc
Collector/Collector	2.4 fc	1.8 fc	1.2 fc
Collector/Local	2.1 fc	1.6 fc	1.0 fc
Local/Local	1.8 fc	1.4 fc	0.8 fc

Light levels are measured in foot candles (fc) which refers to the distance (in feet) that is illuminated away from the source of light, measured in lumens per square foot.

Functional Classification of street types is based on IESNA standards.

**FIGURE 6.9**  
**PEDESTRIAN LIGHT LEVELS**

STREETScape TYPE	LIGHT LEVEL
Commercial	1 fc
Mixed-Use	0.5 fc
Residential	0.4 fc
Industrial	0.3 fc
Alleys and Paseos	0.3 fc
Special	Varies

Light levels are measured in foot candles (fc) which refers to the distance (in feet) that is illuminated away from the source of light, measured in lumens per square foot. Suggested light levels are consistent with ANSI/IES RP-8-00 American National Standard Practice for Roadway Lighting (see below)

**FIGURE 6.10**  
**COMPARISON OF STREETLIGHT TECHNOLOGIES**

LAMP TYPE	EFFICIENCY (LUMENS/WATT)	COLOR RENDERING INDEX (CRI)	LIFE (HOURS)
High Pressure Sodium (HPS)	60 to 140	22	24,000 to 40,000
Metal Halide	60 to 100	65 to 90	10,000 to 20,000
Induction	60 to 70	80	100,000
LED	50 to 100	70 to 80	50,000 to 100,000
Incandescent	9 to 20	96 to 99	1,000 to 2,000

In general, providing sidewalks with a minimum luminance of 0.5 fc allows pedestrians to detect obstacles, stay visually oriented, and recognize faces from a distance of 13 feet, a minimum distance that brings comfort with regard to normal social contact. For high crime or activity areas, higher values may be considered.

Crosswalks should follow Illuminating Engineering Society of North America (IESNA) intersection guidance to illuminate pedestrians in the crosswalk to vehicles (see Figure 6.8). Crosswalk lighting should provide color contrast from standard roadway lighting.

Lighting fixture spacing should be based on light level and uniformity requirements in the American National Standard Practice for Roadway Lighting (RP-8) by the IESNA, the adopted city lighting standard, shown in Figure 6.8. Roadway classifications used in RP-8 are based on traffic volume.

Light levels will decrease as lamps get old and lighting fixtures get dirty. Light levels should be adequate even when light levels decrease over time. Light level calculations should be performed using the light loss factor stipulated by the City to account for these anticipated decreases.

### Existing Light Fixtures – Inventory

Existing light fixture locations should be used wherever possible, but the lighting layout should meet light level and uniformity criteria and other considerations listed in this document. When selecting a fixture, if the SFPUC already has approved and/or is using the same style of fixture, approved fixtures should be used. The quantity of fixture types in the city should be minimized and consolidated to as few as practical while maintaining the aesthetic and technical requirements set forth in this document. New fixture types used in a single installation are discouraged.

The City’s approved palette of light fixtures should be evaluated and updated through a subsequent street lighting master plan.

## MAINTENANCE

### Manufacturer Selection

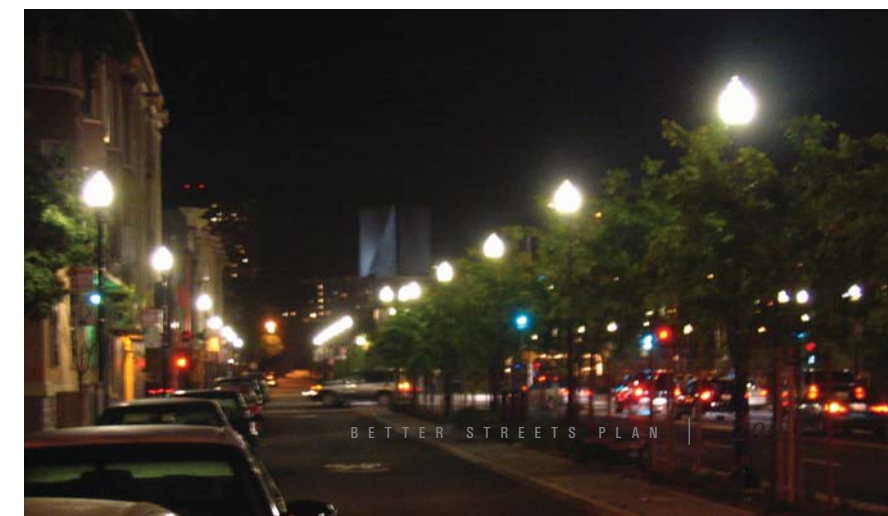
The lamp, parts and accessories for lighting fixture maintenance should be easily accessible in the fixture and obtainable in the market place. When specifying a lighting fixture, the ease of maintaining and replacing the ballast, lamp, lens and other major parts should be evaluated. Fixtures should be easy to maintain. A reasonable parts inventory should be maintained by the City for commonly replaced parts such as lamps, ballasts, and touch up paint. It should also be easy to obtain parts through a local distributor.

Only well established lighting, pole, and lamp manufacturers should be specified. If a lighting manufacturer used by the City goes out of business, another manufacturer with a similar style of fixture should be selected if a fixture or pole has to be replaced in the future. If custom designed lighting fixtures are proposed for a neighborhood, the City should retain ownership of the fixture design so it can be replicated by another manufacturer if the original manufacturer can no longer produce it.

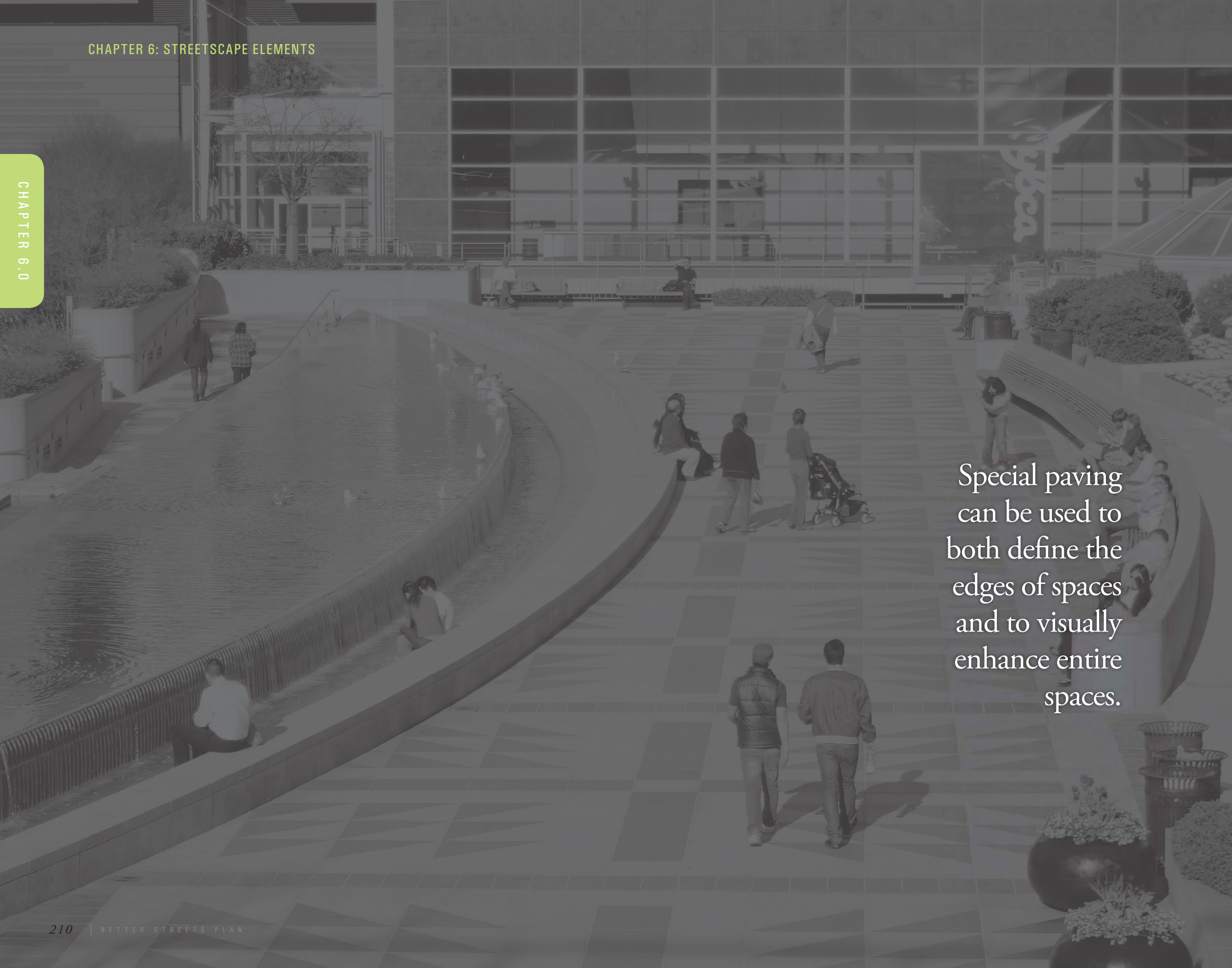
New or replacement pedestrian and street lighting fixtures should be chosen to minimize maintenance and operating costs, and should have a lifespan of 50,000 hours.

### Tree Pruning

Tree pruning is important to maintain uniform light levels on the street. The clearance between tree foliage and the lighting fixture is dependant upon the tree type and lighting fixture type and height. See Section 6.1: Urban Forest.







Special paving can be used to both define the edges of spaces and to visually enhance entire spaces.



# Paving

# 6.4

Paving can consist of traditional paving materials such as concrete or asphalt or non-traditional materials used as accents or in key locations. Typical asphalt and concrete paving are proven materials that meet the standard needs of vehicle and pedestrian circulation; special paving treatments can improve public spaces in a city, give circulation areas a stronger sense of place, and enhance the hierarchy of public spaces. Special paving treatments can be selected from a range of options, including natural stone pavers, unit concrete pavers, bricks, wood, textured and colored concrete, stamped asphalt, and concrete with exposed or special aggregate or other finish treatments.

Special paving can be used to both define the edges of spaces and to visually enhance entire spaces. Special paving is key to communicating pedestrian primacy such as within heavily traveled crosswalks or pedestrian priority spaces, and adds visual variety to the streetscape.

Special paving can be a functional stormwater amenity as well as an aesthetic enhancement, when designed as permeable paving. Permeable unit concrete pavers can provide both function and aesthetic appeal and should be used where an enhanced design treatment is desired. Permeable asphalt and concrete change the surface function but do not greatly enhance the overall aesthetics of the site. See Permeable Paving in Section 6.2.



➔ PLACEMENT

Sidewalks should use standard scored concrete paving at a minimum. In addition, special paving may be included as a component of any street type. Special paving is most appropriate on downtown, commercial, ceremonial, and other special streets or small streets. Specifically, special paving should be considered in:

- ➔ transit stop areas, including transit curb extensions and medians;
- ➔ pedestrian crossings, especially at important civic locations, neighborhood commercial areas, and other special districts;
- ➔ mid-block and raised pedestrian crossings;
- ➔ pedestrian refuge areas within medians;
- ➔ the full right-of-way of shared public ways;
- ➔ local access lanes of multi-way boulevards;
- ➔ pedestrian-only streets, including transit malls, pedestrian malls, and areas that are regularly but temporarily closed to vehicle traffic;
- ➔ flexible space in parking lanes;
- ➔ sidewalk and median pocket parks;
- ➔ curb extensions;
- ➔ the furnishings zone of sidewalks;
- ➔ driveways; and
- ➔ gateways and other special places.



▲ Special paving across the full right-of-way



▲ Special paving in the sidewalk

🔧 GUIDELINES

*Paving type*

**Standard Paving:** Standard sidewalks should use concrete scored in 3' x 3' squares.

Downtown sidewalks should use concrete mix to the specifications of the Downtown Streetscape Plan.

**Special Paving:** Pavers consist of sand set pavers, mortar set pavers, and permeable or porous pavers over clean drain aggregate. Special pavers include natural stone pavers, unit concrete pavers, unit concrete permeable pavers, textured and colored concrete, stamped asphalt, concrete

with exposed or special aggregate, and other finish treatments. Special aggregates, colors, and textures may also be considered. Maintenance cost of special pavers should be considered during the selection process.

When non-customary materials are used, they should extend at least a complete block for design consistency and maintenance efficiency. Similarly, non-customary scoring should extend for at least one block. Exceptions can be made where special paving is being used to highlight transit stops, parks, plazas, or other site-specific features.

➔ Permeable Paving

Permeable paving materials not only create attractive streetscapes but can serve an important ecological role in improving the sustainability of streets. See Section 6.2: Stormwater, for detail.





### Accessibility

Special attention should be paid to accessibility and comfort considerations of paving materials in selecting appropriate locations for different paving types. Paving materials must meet all accessibility standards. Generally:

- Paving materials should not pose tripping hazards or cause excessive vibration for wheelchairs
- Paving should be designed, installed, and maintained to be smooth and level. Surfaces should not be interrupted by steps or abrupt changes in level of more than 1/4 inch.
- Unit pavers must have gaps of no more than 1/4 to 1/2 inch, beveled to no more than a 1:2 ratio.
- Saw cut joints in poured concrete are preferable to troweled joints

- Surfaces with a slope of less than 6% gradient should be at least as slip-resistant as what could be described as a medium salted finish. Surfaces with a slope of 6% gradient or more must be slip-resistant.
- Surface cross slopes should not exceed 1/4 inch per foot except where, due to topography, it creates an unreasonable hardship, in which case the cross slope may be increased to a maximum of 1/2 inch per foot.

Refer to the guidelines below and ADA and Title 24 standards for more information. See DPW standard engineering plans for sidewalks for construction details.

Specific guidance for design of curb ramps is presented in Section 5.1. Curb ramps should be treated in either smooth solid concrete or paving treatment to match adjacent paving.

### Installation

Special paving materials should follow these guidelines:

- Select surface materials with low maintenance requirements and high durability, slip-resistance, and compressive strength.
- Retain a certified geotechnical engineer and reference a geotechnical investigation report for soil type and loading capabilities.
- Understand soil type and settlement potential when choosing a paving surface material and sub-base thickness.
- A proper sub-base is as important as the surface material. Use of a recycled sub-base is recommended. Ask suppliers of recycled materials to provide material testing results for loading equal to Caltrans classification standards.
- Understand the loading needs per the expected use (trucks, emergency vehicles, vehicles, pedestrian-only). The paver and sub-base depth should be designed for the heaviest expected loading per City standards. A concrete slab with mortar pavers is recommended in high traffic areas with heavy loading for long-term durability.
- Settlement may be an issue in areas of high clay content or over “Bay Mud”. An enhanced sub-base or concrete slab base is typically required per geotechnical recommendations.
- Follow manufacturer recommendations for maximum slopes and minimum recommended sub-base depth and material.
- Conduct percolation tests or soil science reports if permeable or porous pavers are used. Where infiltration is not feasible, an underdrain may be used.

### Layout

Special paving can be implemented as a field treatment, consistent across the entire sidewalk, plaza, or shared space, or can define specific areas within the streetscape. Where implemented as a field treatment, it should be organized in regular or organized artistic patterns.

*Special paving at specific locations*

Special paving should be considered for installation in the following locations subject to the guidance elaborated in the related sections of this document. Recommendations are summarized below.

**Furnishings Zone (see Section 4.2):** Special paving in the furnishings zone can visually separate this space from the rest of the sidewalk, highlighting its function as an area to sit or step out of pedestrian flow. Permeable paving, such as pavers set on a clean aggregate gravel subbase, should be used where possible to allow stormwater infiltration, water, and oxygen to reach tree roots below.

**Pedestrian Crossings (5.1):** Special paving treatments communicate to individual users that the crosswalk is part of

- ▼ Special paving can define the transit waiting and circulation area for pedestrians, even where a shelter is not present



pedestrian space, not an encroachment by pedestrians into the roadway. Paving, texture, and color treatments are especially important in places where it is important to make pedestrians more comfortable crossing.

The application of special paving in crosswalks should consider wear and tear caused by vehicles crossing the paving, and requires additional capital and maintenance funding. The paving should be designed and installed to maintain the desired visual and textural appearance. Special paving is not a substitute for standard or high-visibility retro-reflective crosswalk markings. Standard 12 inch transverse lines should still be used outside a decorative crosswalk treatment to establish a marked crosswalk.

**Curb Extensions (5.3):** Where curb extensions are added, they may be designed as useable pedestrian spaces. Special paving can reinforce this intention by visually separating curb extensions from the adjacent sidewalk, and suggesting that these spaces are meant for sitting and relaxing as opposed to just walking.

**Pedestrian Refuge Areas in Medians (5.4):** Special paving should be considered at pedestrian refuges. The pedestrian

- ▼ Special paving at crossings and on pedestrian refuges makes crossing more comfortable for pedestrians



path through the median and adjacent areas may include special paving.

**Transit Stops (5.5):** Special paving treatments should be considered at transit stop locations to define the waiting zone and to clarify connections to transit. Curb extensions and transit boarding islands should be paved with finer-grained paving treatments ranging from unit pavers to special scoring and color in concrete. At transit stop locations where there is no curb extension, distinctive sidewalk treatments such as alternative paving or scoring patterns or an edging treatment in the furnishings zone should be considered.

The sidewalk throughway adjacent to transit stops should be treated similarly to the surrounding sidewalk area to distinguish the transit stop area from the sidewalk throughway zone.

**Flexible Space in Parking Lanes (5.6):** Where parking lanes are re-designed as part of a program of flexible use, special paving should be used to differentiate the parking lane from the adjacent vehicular travel lane and the furnishings zone from the throughway zone. Special paving should be used to designate the outdoor rooms meant for people to sit and relax.

**Pocket Parks (5.8):** Special paving should be considered as an edging treatment around sidewalk pocket parks and planting areas. Travel lanes adjacent to these areas can use special paving to indicate a shared space where pedestrians may cross the street from the sidewalk to the open space. Within such spaces, permeable pavers and other alternative permeable surfaces such as decomposed granite are highly recommended for paths, edging, and other hardscape areas.

**Shared Public Ways (5.8):** On shared public ways, special paving is integral to communicating that the entire right-of-way is a space to be shared between pedestrians and vehicles. Paving patterns and layout should be used to convey the location of spaces within the right-of-way, defining the edges for parking, playing, and sitting, and highlighting the edges of planting areas.

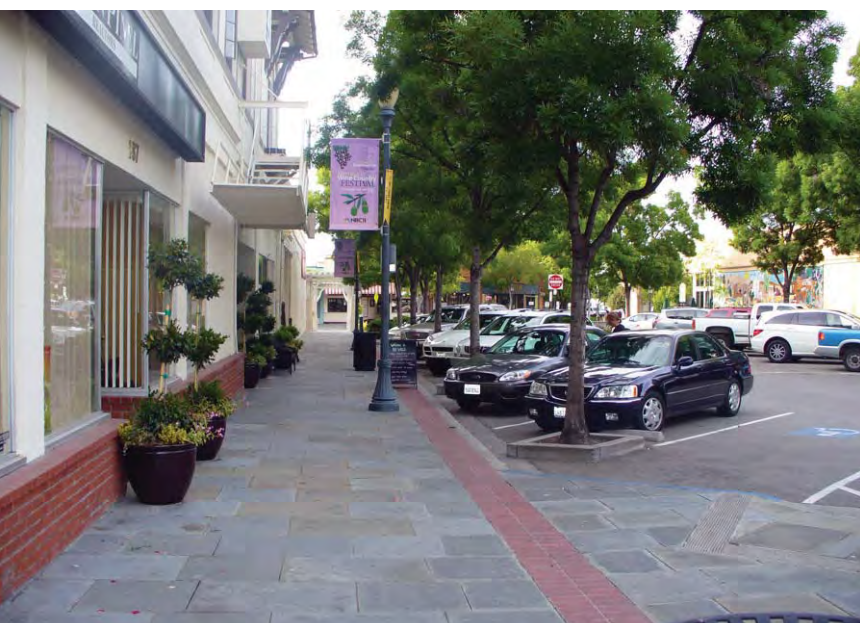
**Multi-Way Boulevards (5.8):** Special paving can be used to communicate the function of the local access lane in bou-





- ▲ Unique paving treatments convey a sense of scale, detail and orientation that is welcoming to pedestrians

- ▼ Paving treatments can be used to accent the sidewalk by outlining trees or entire sidewalk zones

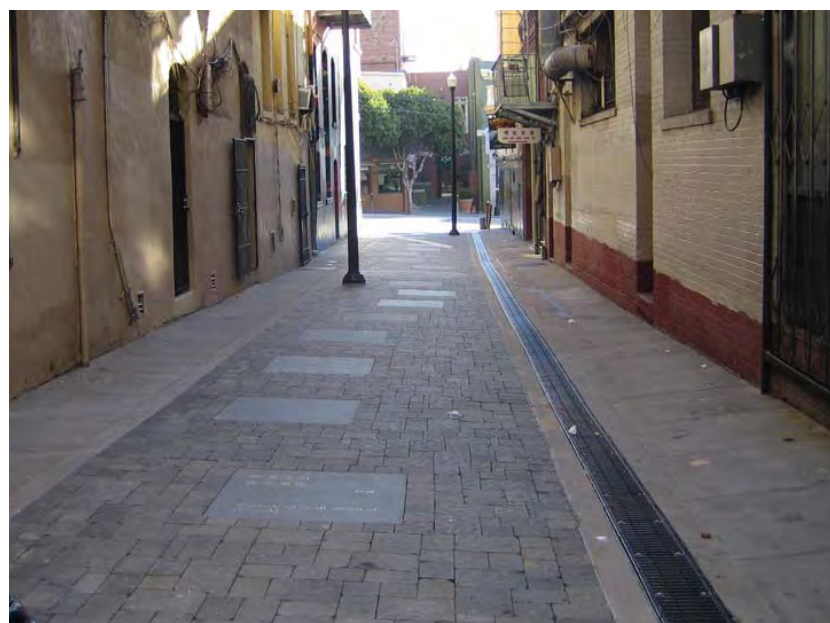


levards. Special paving should be considered for the entire lane to enhance this function. The change in material identifies a space intended for local circulation and that differs from the through lanes in the center of a multiway boulevard, particularly in combination with a shared public way treatment or raised crossings.

**Pedestrian-Only Streets (5.8):** Where a whole right-of-way is converted to pedestrian space or special mixed transit and pedestrian space, or where frequent temporary closure for pedestrian use is considered, special paving should be used to enhance the space for pedestrians. Special paving should be used to define and highlight spaces within the public right-of-way, breaking the space down into a more pedestrian scale.

**Driveways (6.6):** Driveways outside the path of travel can use interlocking pavers, pervious concrete, and other similar materials to add visual variety to the streetscape, and allow infiltration where appropriate.

## OTHER CONSIDERATIONS



### Environmentally responsible material choices

Many paving surfaces, sealants, coatings, traffic markings, and other products are composed of materials that are harmful to the natural environment. The type of material selected should consider the level of volatile organic compounds (VOCs) and specify zero- to low- VOC agents. Polycyclic aromatic hydrocarbon (PAH)-free sealants and/or asphalt bases should be considered.

Many paving surfaces are composed of natural materials derived from highly impactful quarrying and processing methods that are damaging to the natural environment. The City should encourage the use of recycled or reclaimed materials. Granite curbs removed during retrofit should be reused, either on-site or on other streetscape projects.

Streetscape projects should strive to use sustainable paving materials, including:

- **Materials with recycled content:** the sum of post-consumer recycled content plus one-half of the pre-consumer content constitutes at least 20% (based on cost) of the total value of the materials in the project
- **Regionally-harvested materials:** materials or products that have been extracted, harvested or recovered, as well as manufactured, within 500 miles of the project site for a minimum of 20% (based on cost) of the total materials value
- **Rapidly renewable materials:** materials and products made from plants that are typically harvested within a ten-year cycle or shorter for 2.5% of the total value of all materials and products used in the project, based on cost.

The City is currently working on a 'greening checklist' for streetscape projects that would institutionalize these standards.



Site furnishings announce that pedestrians are welcome and that the street is a comfortable place to be. These amenities provide a functional service to the pedestrian and provide visual detail that makes a place comfortable and interesting.



# Site Furnishings

## 6.5

Site furnishings provide important amenities for pedestrians by adding functionality and vitality to the pedestrian realm. They include benches and seating, bicycle racks, bollards, flowerstands, kiosks, newsracks, parking meters, public art, sidewalk restrooms, streetscape signage, traffic and parking signs, trash receptacles, and other elements not specifically discussed here. Transit shelters are discussed in Section 5.5.

Site furnishings announce that pedestrians are welcome and that the street is a comfortable place to be. These amenities provide a functional service to the pedestrian and provide visual detail and interest.

Pedestrian amenities should be considered a requisite public expenditure just as other necessary elements of the street, such as traffic signals and signage. Improved street vitality has marked impacts on public safety and comfort, health of local businesses, local real estate value, and transportation habits<sup>1</sup>.

<sup>1</sup> Case Study No. 20: *The Effects of Environmental Design on the Amount and Type of Bicycling and Walking*, National Bicycling and Walking Study, US Federal Highway Administration.

### ➔ In this section: Site Furnishings

- Benches and seating
- Bicycle racks
- Bollards
- Flowerstands
- Kiosks
- Newsracks
- Parking meters
- Public art
- Sidewalk restrooms
- Streetscape signage
- Temporary private use of the public realm
- Traffic and parking signs
- Trash receptacles





## ➔ PLACEMENT

Site furnishings should be prioritized on:

- ➔ streets with a large amount of pedestrian activity;
- ➔ streets where pedestrians may linger and enjoy the public realm, such as downtown, commercial, mixed-use, or special streets; and
- ➔ streets with a recreational role such as parkways, park edge streets, and boulevards.

Other streets should include site furnishings at corners and busier blocks, or where warranted by adjacent land use and pedestrian activity. Site furnishings should be clustered at transit stops. See Section 5.5.

On residential streets, alleys and on curb extensions on any street, clusters of pedestrian amenities can create attractive and inviting public spaces where neighborhood residents or patrons of local businesses can sit and rest, play, eat, or enjoy people watching.

Specific location guidelines for each element are detailed by element on the following pages.

## 🔍 GUIDELINES

### General

Layout of site furnishings should follow the guidance provided in Section 4.2. Specific guidance for furnishing layout at transit stops is provided in Section 5.5.

Site furnishings should be considered secondary to street trees and lighting. Street tree and lighting placement should define the major rhythm of design elements along the street; site furnishings should be placed in relation to trees and lighting after the best locations for these elements have already been located.

In downtown, site furnishings should follow the Downtown Streetscape Plan.

In addition to the specific guidelines for each element, site furniture should conform to these minimum requirements for sidewalk element placements, unless otherwise noted. Site furnishings should be placed in the furnishings zone not less than:

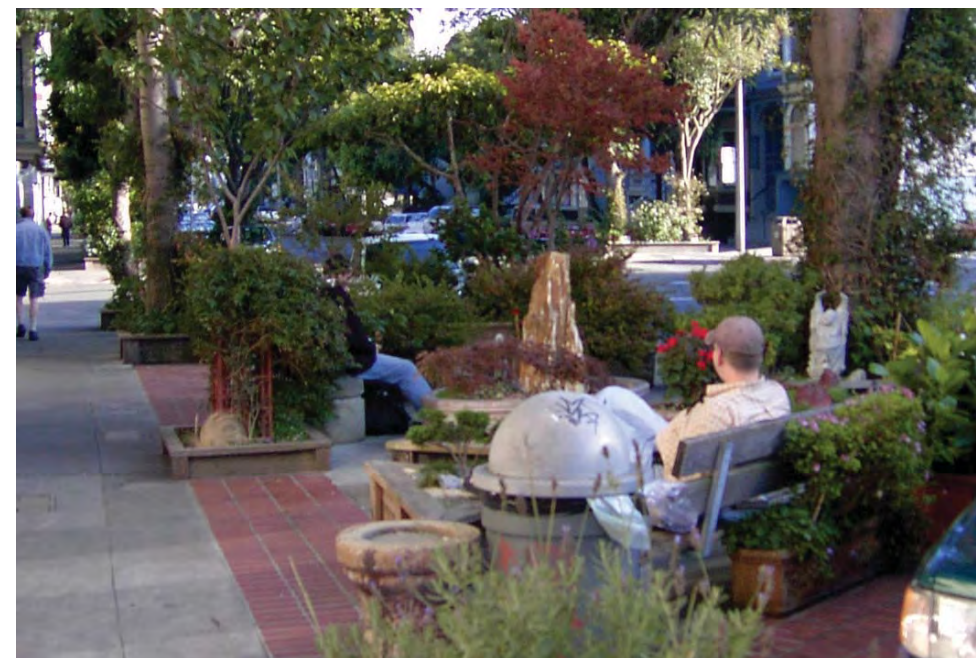
- ➔ 18 inches from the outside edge of the curb;
- ➔ 2 feet from any driveway or wheelchair ramp and 4 feet at the landings of the ramp;
- ➔ 5 feet from any fire hydrant and 2 feet from a stand pipe; and
- ➔ 4 feet from any MUNI transit shelter, except as noted in Section 5.5.

Placement of site furnishings should consider car overhangs and door swings. When placed near the curb, furnishings should be located at the ends of the on-street parking stalls rather than at the center.

Street designs should reduce streetscape clutter by consolidating and reducing the size of miscellaneous site furnishings such as utility poles, call boxes, mail boxes, etc. as much as possible.

Site furnishings may also be placed within curb extensions where sidewalk widths are extended into the parking lane. Dining areas for adjacent restaurants can be located on curb extensions, in flexible parking areas, or in the furnishings zone. See Section 5.3: Curb Extensions and Section 5.6: Parking Lane Treatments.

San Francisco should create a unified, replicable palette of site furnishings that can be customized to reflect the local character of the surrounding neighborhood to contribute to a sense of community identity.



### Accessibility Requirements

All site furnishings must be accessible per Americans with Disabilities Act (ADA) guidelines and City regulations, including the following:

- ➔ Site furnishings must maintain the minimum 4 foot ADA required clear accessible route, and should leave the minimum through widths described in Section 4.2.
- ➔ Objects mounted on walls or posts with leading edges above the standard sweep of canes (27 inches) and below the standard head room clearance (80 inches) should be limited to a 4 inch maximum protrusion.
- ➔ No sidewalk element may interfere with pedestrian access to the entrance of any building; this includes the path of travel and disabled access requirements of ADA and Title 24. This includes all paths of travel or exiting.





## Design Considerations for Accessible Furnishings

Technical provisions for accessible features appropriate to pedestrian facilities may be found in the following sections of ADAAG:

- 4.4 Protruding objects
- 4.15 Drinking fountains
- 4.22 Toilet facilities
- 4.27 Controls and operating mechanisms
- 4.29 Detectable warnings
- 4.30 Signage
- 4.31 Public pay telephones
- 4.32 Fixed or built-in seating and tables

The US Access Board web site [www.Access-Board.gov](http://www.Access-Board.gov) contains proposed and new accessibility guidelines for the Americans with Disabilities Act, the Public Right-of-way and for outdoor recreation that may be appropriate best practices for pedestrian facilities.



- ▲ Seating can be oriented in social layouts or in individual locations to allow people to converse or to sit alone

- Wherever possible, site furnishings should be of a contrasting color to the sidewalk so as to aid pedestrians with visual impairments.
- Site furnishings should leave a minimum 8 feet of clearance adjacent to accessible parking and passenger loading zones.

See Appendix E for a full summary of accessibility guidelines.

### Environmentally responsible material choices

Site furnishings should strive to use sustainable materials, including:

- **Materials with recycled content:** the sum of post-consumer recycled content plus one-half of the pre-consumer content constitutes at least 20% (based on cost) of the total value of the materials in the project.
- **Regionally-harvested materials:** materials or products that have been extracted, harvested or recovered, as well as manufactured, within 500 miles of the project site for a minimum of 20% (based on cost) of the total materials value.
- **Rapidly renewable materials:** materials and products made from plants that are typically harvested within a ten-year cycle or shorter for 2.5% of the total value of all materials and products used in the project, based on cost.
- **Certified wood:** use a minimum of 50% of Forest Stewardship Council's (FSC) certified wood-based materials for wood components.

The City is currently working on a 'greening checklist' for streetscape projects that would institutionalize these standards.

### Benches and seating

Public seating warrants particular attention because it creates a comfortable, useable, and active public environment where people can rest, socialize, read, or people-watch. It is a simple gesture that can go far to create an important sense of place. Seating creates places where people can see and be seen. This ability to entice people to linger is the hallmark of great and successful public spaces.

#### Location of benches and seating

Seating arrangements should be located and configured according to the following guidelines:

- Seating should be located under trees where possible to provide shade and comfort and to integrate multiple elements.
- Informal seating (low walls, etc.) may also be incorporated into other elements in the site furnishings zone, such as planter edges. Where space allows, benches can be built into planters.
- Where seating is oriented parallel to the curb, it should face toward buildings when located in the furnishings zone, or away from buildings when located in the frontage zone.
- Where sidewalk width permits, seating in the furnishings zone should be perpendicular to the curb.
- On curb extensions, seating should be organized to create social spaces.
- Seating incorporated into building forms, such as seat-walls, may be used as an alternative to free-standing benches.
- Seating should be designed to encourage sitting and to discourage lying down.

Given the visual character and amenities in San Francisco and the areas around it, there are many scenic locations where varying from some of these guidelines may be appropriate in order to take full advantage of a street's setting.



For example, seating may be oriented towards a view, rather than towards a street when doing so would provide an additional amenity.

Unfortunately, in some cases fear of loiterers has resulted in seating that is so uncomfortable that no one would want to use it, or the removal of pre-existing seating altogether. The City should maintain a strong presumption against removing seating in the public right-of-way, and should include seating as a standard pedestrian furnishing in new streetscape design projects to encourage usability and activation of the public realm.

**Design of benches and seating**

Seating and other amenities should be made of durable, high-quality materials. Seating should complement and visually reinforce the design of other streetscape elements.

Seating should be designed as an integrated part of other streetscape elements where possible, including:

- integrated seat walls in pedestrian refuges;
- seat walls and benches around trees and landscaping;
- part of public art and gateway monuments; and
- other elements where integration improves utility of the element to pedestrians without compromising its primary function.

50% of public benches in a group, or at least 1 bench, must be ADA accessible. See Section 4.32 of ADAAG.

Temporary or moveable seating may also be used, particularly in locations where there is active street management by adjacent businesses, a merchant’s association, or the like. Temporary seating allows people to orient seats to meet specific social and microclimate needs. Moveable seating and tables for sidewalk dining must comply with DPW permit requirements. See Temporary Private Use of the Public Realm, this section).

**Bicycle racks**

Detailed discussion of bicycle racks can be found in the San Francisco Bike Plan; this plan focuses on design and interaction with other streetscape elements. Bicycle racks are an important element of the streetscape, both as an aesthetic aspect of the streetscape and as a functional element for those who travel by bike. According to the 2000 US Census, San Francisco has the highest percentage of residents who commute to work by bicycle among cities with a population of 500,000 or more.

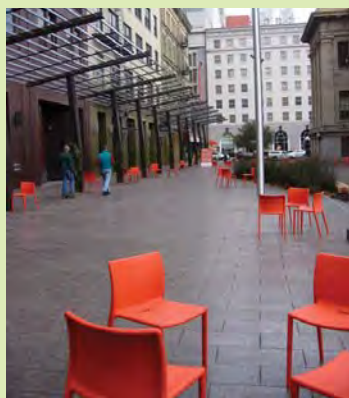
Bicycle racks are also opportunities for distinctive design and public art elements. Where part of a special maintenance or public art program, uniquely designed yet functional bicycle racks are encouraged.



▲ Seating should be integrated with other elements, such as tree guards, where possible



▼ Bike racks should be located near other streetscape elements, such as trees and planters, to cluster amenities



**Best Practice: Mint Plaza**

San Francisco, California

Mint Plaza is a former alley that was recently converted to a pedestrian plaza. Mint Plaza is a finely detailed pedestrian space, with high quality paving stones, attractive trellises and landscaping, and small businesses including new cafes. The plaza was designed with detectable and discernable edges following the original sidewalks to provide a clear path of travel for people with visual impairments.

The plaza has a variety of landscape features with built in seat walls as well as a number of tables and chairs that can be moved to allow people to rearrange the furnishings to fit their needs or comfort, adding chairs for bigger groups or moving into the sun or shade to be more comfortable. This high level of design detail and the freedom to set up a table anywhere on the plaza allows pedestrians to feel comfortable using this urban space.



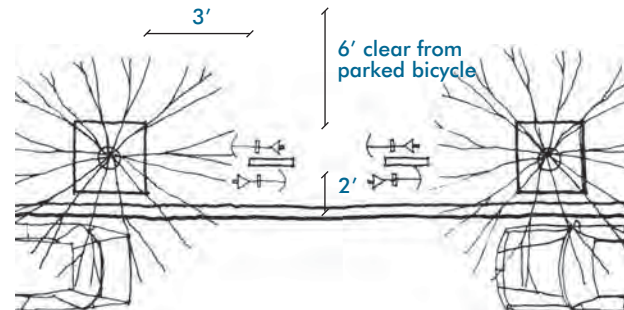
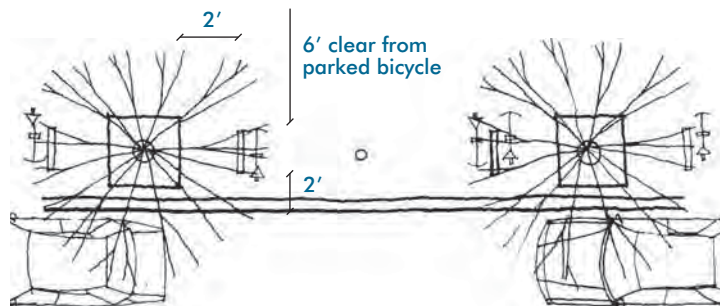


◀ Parking lane bicycle racks should be considered at popular destinations, such as this one at the San Francisco Main Library



◀ Bike racks can be combined with other streetscape elements such as tree guards

▼ Appropriate bike rack placement  
LEFT: Wide sidewalks (generally > 12')  
RIGHT: Narrow sidewalks (generally < 12')



**Location of bicycle racks**

Bicycle racks should conform to SFMTA's bicycle rack placement criteria.

Bicycle racks should be located according to the following guidelines:

- Bicycle racks should be frequent in active commercial districts. Racks should be provided near major destinations such as schools, libraries, transit stops, major shopping and service destinations, and other locations with high pedestrian traffic.
- Where parking meter consolidation programs (as described later in this section) are implemented, bike racks should be provided to replace meter poles, or meter poles should be retrofitted with rings to allow bike parking.
- Racks should be located in either the furnishings zone or on curb extensions where possible. Racks should not be placed at accessible parking or passenger loading zones.
- At transit stops, bike racks should be placed near the back of the transit stop, further from the shelter (where present), or be placed outside of but adjacent to the transit stop. Bike-sharing pods, where provided, should be placed outside of but adjacent to the transit stop.

- Placement and spacing of bicycle racks should consider dimensions when occupied.
- Bike racks placed in the furnishings zone should be perpendicular to the curb where sidewalks are wide enough so that bikes parked at them do not project

into the throughway or edge zone. Where this space is not available, bike racks should be placed parallel to the curb. Perpendicular bike racks should be placed at either edge of a tree basin, a minimum of 2 feet from the edge to allow a person to easily pull their bike in and out.

- A rack should be at least 2 feet from the curb, with 3 feet preferred.
- Bicycle racks should not be located directly in front of a store/building entrance or exit or in a driveway.
- There should be at least 3 feet of clearance between bicycles parked at racks and any other street furniture, with the exception of other bike racks, which should be placed a minimum of every 3 feet on center.
- Bicycles parked at a rack should have a minimum 1 foot clearance from utility vaults.

**On-street bike parking:** Where sufficient demand exists or where sidewalk space is constrained, replacing an on-street vehicle parking space with bicycle parking should be considered. See Section 5.6.

**Design of bicycle racks**

Design and selection of bicycle racks should be designed to the following guidelines:

- The inverted “U” rail rack is the preferred rack for normal sidewalk installation.
- A bike rack should be sturdily attached to the ground to prevent theft
- Galvanized or stainless steel materials that are not powder-coated are more secure and are easier to maintain; where there is a specialized streetscape palette with particular design scheme, bicycle racks should be considered that match other site furnishings.



The inverted “U” rail rack is the preferred rack for most sidewalk installations



- All elements of a bike rack should have a minimum 2 inch diameter (or 2 inch square tube)
- Racks should offer a minimum of 2 points of support for bikes unless the rack can support a bike in two places, such as a post and ring configuration

New designs that integrate decorative tree guards with bicycle parking should be considered for their efficiency in providing more benefit to the streetscape and maintaining more open space on the sidewalk. Artistic bike racks or racks integrated with other elements should also follow the above recommendations.

New development should be encouraged or required to install on-street bike racks as part of development approvals where appropriate.

**Bike sharing:** Bike sharing, if implemented in San Francisco, will require a substantial number of new bicycle racks throughout the City. In such circumstances, conversion of on-street parking to bicycle parking may be necessary. See Section 5.6.

### Bollards

Bollards are primarily a safety element to separate pedestrians or streetscape elements from vehicles. Attractively designed bollards add color and interest to streetscapes, help define pedestrian spaces, and provide a spot to lean on or rest at.

#### Location of bollards

Bollards should be located according to the following guidelines:

- Bollards should be used at sidewalk locations where vehicles attempting to park are damaging sidewalk structures, trees or plantings, furnishings, or adjacent private property, especially on narrow streets.
- Bollards should be considered for installation on median islands, curb extensions (except transit bulb-outs), and mid-block curb extensions, where there is a risk of danger to pedestrians due to proximity of travel lanes.

- Attractive bollards can also be used in special locations, including pedestrian-oriented spaces such as shared public ways or pedestrian-only streets, to designate unique spaces. Lighted bollards can create a special pedestrian environment, and may be particularly useful to provide additional pedestrian lighting in median refuges.
- Removable bollards should be placed at entrances to streets that are closed to vehicles for pedestrian use, to alert drivers to the changed nature of the street. Similarly, removable bollards can define the outside edge of flexible parking spaces (see Section 5.6) where the space has been converted to pedestrian use.
- Bollards should be placed 18 inches from the back of the curb. If there is no parking in the bollard placement area, the bollard may be installed immediately adjacent to the back of the curb.
- Standard bollard spacing is approximately 10 feet on center, but may need to be reduced where there is a need to block vehicular traffic. Spacing should vary to sync with the rhythm of lighting fixtures, trees and landscaping, or other elements in the streetscape.

#### Design of bollards

Bollards typically range in size from 4 to 10 inches in diameter; decorative bollards can be larger and vary in form.

Bollards should have articulated sides and tops to provide design detail. Bollards should be painted in colors other than gray to be easily seen by the visually impaired, in colors that complement other streetscape elements. Bollards should be designed within a 'family' of streetscape elements.

In circumstances where bollards are used to temporarily close a street or flexible parking space, removable bollards should be designed with long sturdy pipe projections from the bottom that fit into a hole in the ground. Removable bollards should be designed and installed such that, when in place, they are sturdy and look permanent. Electronic retractable bollards that can be lowered into the roadway to selectively allow vehicles to pass, should be considered where streets are closed to allow emergency vehicle access.



▲ Bollards protect pedestrians from passing traffic and can be an attractive streetscape accent



▲ Bollards come in a variety of sizes and designs.



## Flowerstands

Flowerstands should not exceed 3 feet in width and 10 feet in length. The total flowerstand area (including displays) should not exceed 5 feet in width and 20 feet in length.

A minimum of 6 feet clear pedestrian passage between the edge of the display area and other objects should be maintained on the sidewalk at all times in front of flower stands.

For flowerstands outside of the public right-of-way, only temporary displays should be located in the public sidewalk area. These displays should not exceed 2 feet in width.



▲ Pedestal-mounted newsrack

## Kiosks

Kiosks are public elements that are sources of information, and may include maps, bulletin boards, or other useful information. Kiosks can often be combined with gateway signage and provide an attractive and useful streetscape element.

### *Location of kiosks*

Kiosks should be located according to the following guidelines:

- Kiosks should be located in the furnishings zone, leaving required throughway and edge zone widths.
- When more than one kiosk is installed on a street, all kiosks should be placed on the same axial line at regular intervals.
- Public service kiosks (those primarily providing information) should be separated by at least 150 feet per block face with a maximum of two kiosks per block face. No more than two kiosks should be placed at any intersection.
- Whenever possible, public service kiosks should be placed at red curb zones that are not transit stops.
- Whenever possible, Kiosks should be placed on corner and mid-block curb extensions.
- Kiosks should not be placed within transit stops.
- Kiosks should be placed such that they do not block scenic views.

### *Design of kiosks*

Kiosks should be designed to the following guidelines:

- Kiosks should communicate information by including bulletin boards for community posting, enclosed cases for display of city information, or permanent lettering. Where a kiosk serves as a gateway element it should include a neighborhood, commercial district, street, or park name or other information.

- Sidewalk kiosks must conform to the guidelines outlined in Department of Public Works Order 163,368.
- When more than one kiosk is installed on a street, all kiosks should be of the same, or complementary, design and scale.
- Kiosks can be artistic and expressive. They should reflect an area's special character through their design and can be integrated with public art.
- Kiosks should include braille and be multi-lingual as necessary and appropriate to the specific location.

## Newsracks

In addition to the following guidelines, newsracks are subject to all of the guidelines in the City and County of San Francisco Public Works Code, Part II, Article X, Section 5.4 and all applicable Department of Public Works orders.

### *Location of newsracks*

Newsracks should be located according to the following guidelines:

- The ideal location for a newsrack is next to a red curb that is not marked for a bus stop.
- Only 1 six-unit pedmount newsrack may be placed behind the curb of any passenger loading (white) zone.
- Newsracks should be placed in building setbacks, instead of the furnishings zone wherever possible, with the property owner's approval.
- Where newsracks are located in the furnishings zone, placement should meet the minimum clear width with the newsrack door open. This clear width should be at least 8 feet in downtown areas per the Downtown Streetscape Plan.
- Newsracks should be placed no closer than 2 feet from adjacent street signs and 4 feet from bike racks.

- No newsrack should be placed within 6 feet of the curb for the length of any bus zone.
- A maximum of five free-standing newsracks may be placed in a continuous row. No more than two ped-mount newsracks may be placed within 5 feet of each other except if the sidewalk is 25 feet wide or greater, in which case up to 3 pedmounts can be placed.

**Design of newsracks**

Where possible, newsracks should be consolidated into a single integral cabinet. The cabinet should have an attractive, clean, and simple design that complements the design and color of other street furniture. Newsracks should be permanently affixed to the sidewalk

**Parking meters**

Parking meters are commonly found on downtown and commercial streets. Parking meters can be either traditional single-space meters or consolidated multi-space meters.

Many cities are moving toward multi-space meters as a parking management tool. Multi-space meters also have an important impact on streetscape aesthetics and, where implemented, should consider the recommendations of this section. Consolidating parking meters can reduce the number of poles in the sidewalk by combining multiple parking meters on a block face, resulting in a less cluttered visual environment. This may allow for the installation of additional trees or site furnishings.

**Placement**

Single space meters should be placed in the edge zone. They should be placed at the front end of individual parking stalls.

Multi-space meters may be placed in the edge zone or furnishings zone. Consolidated parking meters typically require installation of an entire new unit, and cannot be affixed to existing meter poles. Typically, multi-space meters should be placed every 8 to 10 parking spaces, roughly 150 to 200 feet apart.

Signage should clearly direct patrons to the multi-space parking meter. Signage directing patrons to multi-space meters should be placed every 100 feet (4 to 5 parking spaces).

**Design and consolidation**

From a streetscape design standpoint, the City should encourage the conversion of single space meters to multi-space meters to reduce the number of elements in the streetscape. However, the decision to convert should be made on the basis of parking management considerations.

When converting single-space meters to multi-space meters, old parking meters and poles should be removed. When meter poles are removed, consideration should be given to adding bicycle racks along the street to replace bicycle parking lost from removal of meter poles.

Multi-space meters should be selected to minimize their footprint on the sidewalk.

Some payment mechanisms require striping, and in some cases numbering, of individual spaces on the roadway while others allow cars to freely fill in the entire block. Where roadway striping and/or numbering is required it should be minimal and not visually distracting or unnecessarily large.

Technical provisions for controls and operating mechanisms may be found in section 4.27 of ADA Accessibility Guidelines.

**Public art**

Public art is an important aspect of major streetscape design projects. On a large scale, public art has the ability to unify a district with a theme or identify a neighborhood gateway. At a pedestrian scale, it can provide visual interest for passersby.

Public art is not a replacement for good urban design. Public art can add interest and delight to a pedestrian's experience. However, streets and all streetscape elements should also be designed to promote pedestrian and public space use.



▲ Multi-space parking meters are used in many cities across the country



▲ Mundane objects such as water fountains can incorporate public art





### ➔ Best Practice: Growing Vine Street

Seattle, Washington

This proposal for Seattle's Vine Street seeks to integrate public art and ecological considerations. The project's main objectives are to reveal and re-introduce the natural hydrologic cycle into the urban setting; create a neighborhood green space; and provide opportunities for functional public art.

The project's central concept is to create a "runnel" (a narrow water channel) lined with native greenery along the entire eight-block length of the street. Stormwater would be collected through large roof cisterns and would be discharged into the runnel for treatment and filtration.

#### *Location of public art*

Public art should be located on streets and in public spaces with high volumes of pedestrian traffic, particularly at key points or intersections. It may also be located in areas where few people pass to create unique and special places for people to enjoy. Downtown streets and boulevards are particularly appropriate for the former, while stairways and pathways provide unique spaces, often distinct to San Francisco, that fulfill the latter.

Arts Commission approval is required on projects that create new structures in the right-of-way per Section 3.19 of the Administrative Code (the Public Art Ordinance).

#### *Design of public art*

Public art is unique to each situation; however, the following guidelines apply:

- ➔ Public art should be located so as to be a pedestrian amenity. A piece can act as a focal point in a park or plaza or present a "surprise" along a pedestrian path that rewards the passerby with visual interest.
- ➔ Consideration should be given to incorporating art into otherwise standard street elements such as light poles, benches, trash receptacles, and utility boxes.
- ➔ Art can provide information, such as including maps and signage, or be educational in regards to the history and culture of San Francisco's neighborhoods and citizens. All installations do not need an educational mission, however—art can be playful.
- ➔ Public art should be accessible to persons with disabilities and must not be placed in a way that compromises the clear path of travel. Art pieces may require detectable warning strips around the base of the art piece.

Public art should be considered during the planning and design phase of development to more closely integrate art with other streetscape elements.

- ▶ Public art can be functional or include functional elements, such as an attractive bicycle rack or an element that includes seating

#### Sidewalk restrooms

##### *Location of sidewalk restrooms*

Sidewalk restrooms should be located according to the following guidelines:

- ➔ Sidewalk restrooms should be located in the furnishings zone, a minimum of 2 feet from the outside edge of the curb.
- ➔ Sidewalk restrooms should be placed a minimum of 40 inches from existing sidewalk elements such as street trees, benches, and lighting poles.
- ➔ Sidewalk restrooms are not permitted on sidewalk less than 14 feet wide, or on any sidewalk on which their placement would cause pedestrian clear width to be less than the minimum width by street type discussed in Section 4.2. Wider space may be desired in locations with significant pedestrian activity.
- ➔ Wherever possible, sidewalk toilets should be placed at red curb zones that are not bus stops.
- ➔ Sidewalk restrooms should be placed such that they do not block scenic views.





- Sidewalk restrooms should not be located on a sidewalk fronting a restaurant, café, or any other eating establishment. Wherever possible, units should be placed out of the line of vision of any eating establishment. They are not recommended within 50 feet of an existing restaurant or an existing permitted sidewalk café or food market.
- The placement of the sidewalk restroom should not visually or physically obstruct the functioning of an existing, permitted flowerstand or sidewalk vendor.
- Sidewalk restrooms should not be located in front of a building entry and the entry to the restroom should be oriented away from the closest building entry when possible.

Sidewalk restrooms must conform to the guidelines outlined in Department of Public Works Order No. 163,369.

### Streetscape signage

The purpose of streetscape signage, including gateway markers and directional signage, is to provide an overall image of a neighborhood or district, mark edges or entry points, and give information about directions, destinations, or the neighborhood in general.

Streetscape signage plans should be developed on a neighborhood basis, specific to the needs of that district. They are most appropriate to downtown, commercial, or tourist-oriented locations, or around large institutions. Less traveled areas may still include some basic informational signs or neighborhood markers.

Streetscape signage includes a hierarchy of types, from most prominent and central, to least prominent and more common. A hierarchy of streetscape signage includes:

- gateway markers (neighborhood or district entry elements);
- neighborhood orientation signs;
- interpretive signs;

- directional/wayfinding signs; and
- standard street and transit signs.

All types of streetscape signage should follow the general guidelines stated in previous sections of this plan (e.g. location in the furnishings zone, retain sufficient clear path of travel, etc.). In addition, they should follow the guidelines listed here.

#### *All streetscape signage should:*

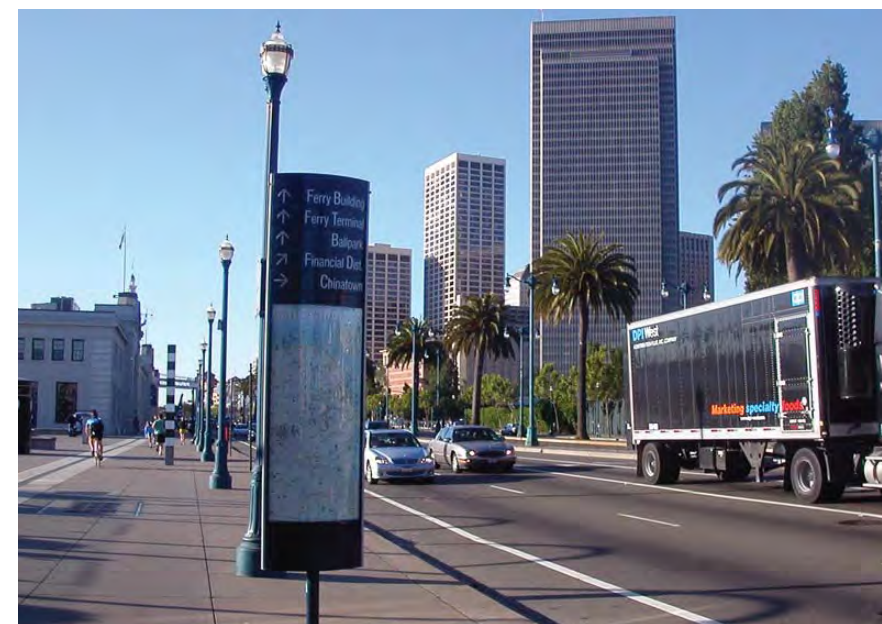
- be placed at strategic locations with a goal of minimizing the overall number of signs and signage systems necessary; overuse dilutes their effectiveness and clutters the streetscape;
- catch the attention of passers-by but complement the overall streetscape design;
- align with existing site furnishings or be otherwise located out of the path of travel;
- include braille and be multi-lingual as necessary and appropriate to the specific location;
- use a consistent graphic design template; signs that highlight local district or neighborhood character should be encouraged and should be of a similar look and feel throughout that district to enhance the area's sense of place; and
- incorporate neighborhood-specific or artistic elements; flexibility should be granted to artisans and craftspeople to create unique signage.

#### *Gateways*

Gateways are markers or monuments located at the entrance to a district or neighborhood to announce the entry to a particular area, or a transition from one area to the next. Gateways may be a literal gateway, markers on either side of a street, a singular large sculptural or iconic element, or even a unique landscape feature or plaza. They are generally more artistic or sculptural, and less literal or functional than other types of signage. Gateway markers should:



▲ Sidewalk restrooms can be an important amenity for pedestrians, but they should be carefully placed to ensure adequate pedestrian circulation and that they not negatively impact adjacent land uses or views



▲ Wayfinding signage should be in locations with high pedestrian traffic and should be attractive, fitting in with the style of other street amenities, and easily usable to both residents and visitors





▲ Gateway elements can define the entrance to and identity of a neighborhood or retail district

- be located at defined entry points to a district or a neighborhood, or transitions from one neighborhood or district to another. They may also be appropriate at areas where a freeway becomes a surface road, or where there are other significant changes to the roadway, land use, or building form (for example, where a major roadway becomes a quiet residential street);
- be large enough to attract attention and identify the neighborhood entrance;
- incorporate unique artistic, sculptural, or culturally-expressive elements appropriate to the particular neighborhood context; and
- be placed on corner and mid-block curb extensions whenever possible.

#### ***Neighborhood Orientation Signs***

Neighborhood orientation signs provide a central element to provide district or neighborhood information, including the area's name, neighborhood map, list of destinations (such as primary cultural institutions, historical buildings, and sites of significance), with a distinctive, coordinated design. Neighborhood orientation signs should:

- be located at key points in the neighborhood, such as at a major transit stop, or a central public space;
- include directories/maps to guide people to various neighborhood resources;

- highlight public and private destination points, including shopping, cultural and recreational facilities, parking, restrooms, and other public-serving facilities; and
- when appropriate and feasible, use new technologies such as interactive and virtual displays with event or other real-time information; however, such design features should be respectful of the neighborhood context and minimize visual intrusion.

#### ***Directional Signs***

On most streets, the typical street sign is all that is needed to orient pedestrians to major destinations. However, on streets and public spaces with heavy pedestrian volumes, additional directional signage is often helpful. This is especially true on streets that handle greater numbers of visitors (such as downtown, ceremonial, or commercial streets), on major transit routes, or in tourist-oriented areas.

Directional signs are typically much simpler than a neighborhood orientation sign, featuring only place names and wayfinding information. They should have a distinct and coordinated design in keeping with the character of the surrounding neighborhood or district. Well-designed directional signs can help create a distinct identity to a neighborhood. In general, directional signs should:

- include destination icons, place names, and directional markers (e.g. arrows) for local destinations on blades or integral to the body of the sign. A map clearly showing current location and the best routes to nearby destinations should also be considered



Gateway and neighborhood orientation sign



#### **➔ Historic/Adventure Trail Markings**

Historic and adventure trails highlight unique city spaces, such as historic, civic, and cultural destinations, parks and open space, and unique streets, trails, stairs, and paseos. They can be integrated into sidewalk pavement, the sides of buildings, poles, or public art or other special furnishings to add unique detail and an educational dimension to the streetscape. Trails can be located on any street, and will often cross many street types, plazas, and open spaces as they meander through the city. Trail signage should be complemented by maps, brochures, and other information that can be taken away by people who use the trail. Sidewalk markings are permitted through DPW, and applicants are responsible for their maintenance.



- share existing poles where possible consistent with the signage design, or be designed as an integral streetscape element. Historic streetlight poles, however, should not be used;
- be located in the furnishings zone and as near to intersection corners as is practicable (but outside of the corner zone);
- be easy to spot from far away, but designed to be read from near by a pedestrian with a high level of detailing and craftsmanship; and
- use external illumination that focuses light on the signs themselves, not on pedestrians. Internally illuminated signs should be avoided as they are typically designed to attract drivers and are too intense for pedestrians. Directional signs should use reflective coating to minimize glare.

**Interpretive Signs**

Interpretive signs give historical, cultural, natural or architectural information about their particular locale. They may be part of a historic trail, identify a particular site where an important event occurred, or describe other aspects of a neighborhood’s past or present. Interpretive signs should:

- include graphics and photos, with a bold, strong heading and clear, succinct text;
- use a unique, neighborhood-specific design that incorporates creative or artistic elements into the overall design; and
- be coordinated with a centralized directory and map when appropriate.

**Standard Street and Transit Signs**

Standard street and transit signs give basic directional information about street names or transit lines. They are typically located on all street corners and transit stops. They should be built to citywide standards for street or MUNI signs.

**Temporary private uses in the public realm**

In addition to permanent public fixtures, site furnishings also include moveable or temporary elements or uses, typically placed in the sidewalk area by private businesses or residents. Temporary private uses in the public realm are generally encouraged as they create a lively and colorful street environment, animate public space, and provide ‘eyes on the street’. However, they should be designed and located to ensure safety, accessibility, and appropriate maintenance. Temporary elements include:

- outdoor café and restaurant seating;
- merchandise displays;
- street food vendors (Pushcarts and peddlers); and
- street artists.

These uses are permitted through various City agencies, including DPW, DPH, Police, Fire, Planning, and others. Permit requirements and responsible agencies are summarized below.

**Outdoor café and restaurant seating**

Outdoor café and restaurant seating (tables and chairs) is encouraged to activate the sidewalk environment and encourage economic development. Outdoor café and restaurant seating require a Street Use Permit from DPW.

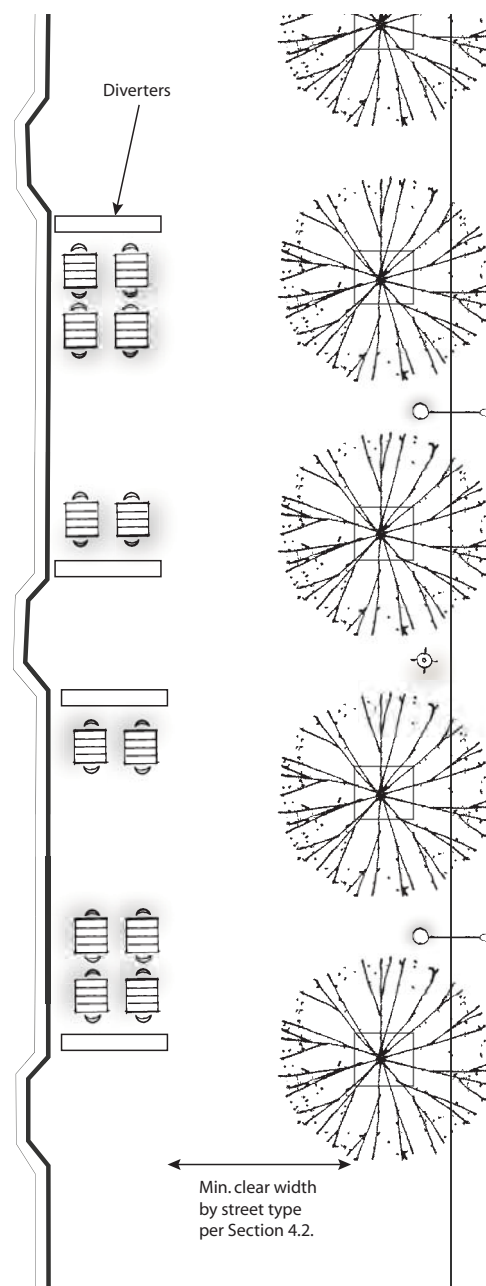
Tables and chairs should abide by the following guidelines:

- Tables and chairs can be placed only on the sidewalk in front of the applicant’s place of business.
- The sidewalk in front of the business must retain a minimum pedestrian clear width per Section 4.2. This clearance must be free of all obstacles.
- Placement of tables and chairs on the sidewalk must not in any way interfere with curb ramps, access to the building, driveways or access to any fire escape.



▲ Outdoor seating enlivens the pedestrian realm





▲ Outdoor cafe and restaurant seating

- Tables and chairs are allowed in the frontage zone where sufficient sidewalk width is available.
- Tables and chairs may also be permitted in the furnishings zone, on a case-by-case basis as determined by DPW. DPW will consider safety (risk from passing vehicles) and accessibility (people crossing the pedestrian thoroughway) in their review. Tables and chairs in the furnishings zone are more appropriate on calmer streets or where a buffering element (such as planters or parked vehicles) between the sidewalk and travel lanes exists. Tables and chairs in the furnishings zone must be located so as to maintain access to parked vehicles, and may not be located on sidewalks adjacent to accessible parking (blue) or passenger loading (white) zones.
- Placement of tables and chairs on the sidewalk must include diverters at each end to guide pedestrians away from the occupied area of the sidewalk. Diverters must:
  - be flush with building at approximately 90 degrees;
  - be sturdy, stable, and have sufficient weight so that they cannot tip over or be blown away by the wind;
  - be at least 30-inches high and must be solid within 24-inches of the ground;
  - have contrasting colors so that they are distinctly visible to the visually impaired; and
  - be removable at the end of business hours.

In some locations, temporary café and restaurant seating may be located in the parking lane, where there is a program for flexible use of the parking lane. See Section 5.6.

### **Merchandise displays**

Sidewalk merchandise displays can enliven the pedestrian realm and enhance the viability of retail establishments in commercial districts. Merchandise displays require a Street Use Permit from DPW.

Merchandise Displays should abide by the following guidelines:

- Merchandise Displays may be placed only on the sidewalk in front of the applicant's place of business
- The sidewalk in front of the business must retain a minimum pedestrian clear width per Section 4.2. This clearance must be free of all obstacles.
- Placement of merchandise displays on the sidewalk must not in any way interfere with curb ramps, access to the building, driveways or access to any fire escape.
- The top of the display, including stand and merchandise, must be at least 2 ½ feet above the sidewalk. The top of the display may not be more than 3 feet and 10 inches above the sidewalk nor more than 2 feet or 25% of the width of the sidewalk in front of the building (whichever is less).
- Display of fruits and vegetables must be protected by an awning, which must extend a minimum of 6 inches beyond the full length and width of display racks.
- The finish materials used for display merchandise must be smooth, non-absorbent and cleanable.



**Street vendors (Pushcarts and Peddlers)**

Street vendors (pushcarts and peddlers) – selling food or other items – can enliven a district and provide jobs and services. Pushcarts and peddlers are permitted through the Police Department. Food vendors also require permits from the Department of Public Health. Other City departments may also review permit applications. Permitted Pushcart and peddlers must abide by the following:

- Permits are for one location only.
- Pushcart and peddler permits may not be issued for a location within 2 blocks or 600 feet, whichever is greater, of an established business which sells the same type of food or other merchandise as the applicant, or of any location currently being operated by a peddler or pushcart peddler selling the same type of food or other merchandise.

→ Pushcart and peddler locations must:

- leave a minimum of 10 feet of unobstructed space for pedestrian passage on any sidewalk;
- not occupy a space extending more than 4 ½ feet from the curb line of any sidewalk, nor wider than 4 feet, nor extending more than 5 feet above the sidewalk;
- not be within 18 inches of the curb line of any sidewalk;
- not be closer than 7 ½ feet from the sprinkler inlets, wet and dry standpipe inlets, measured from the outer edge of the standpipe bank from the building line to the sidewalk edge;
- not be within 12 feet of the outer edge of any entrance way to any building or facility used by the public including, but not limited to doors, driveways, and emergency exits measured in each direction parallel to the building line at a 90 degree angle to the curb;
- not be on any sidewalk adjacent to a white, yellow, blue, or red zone, or a bus zone;

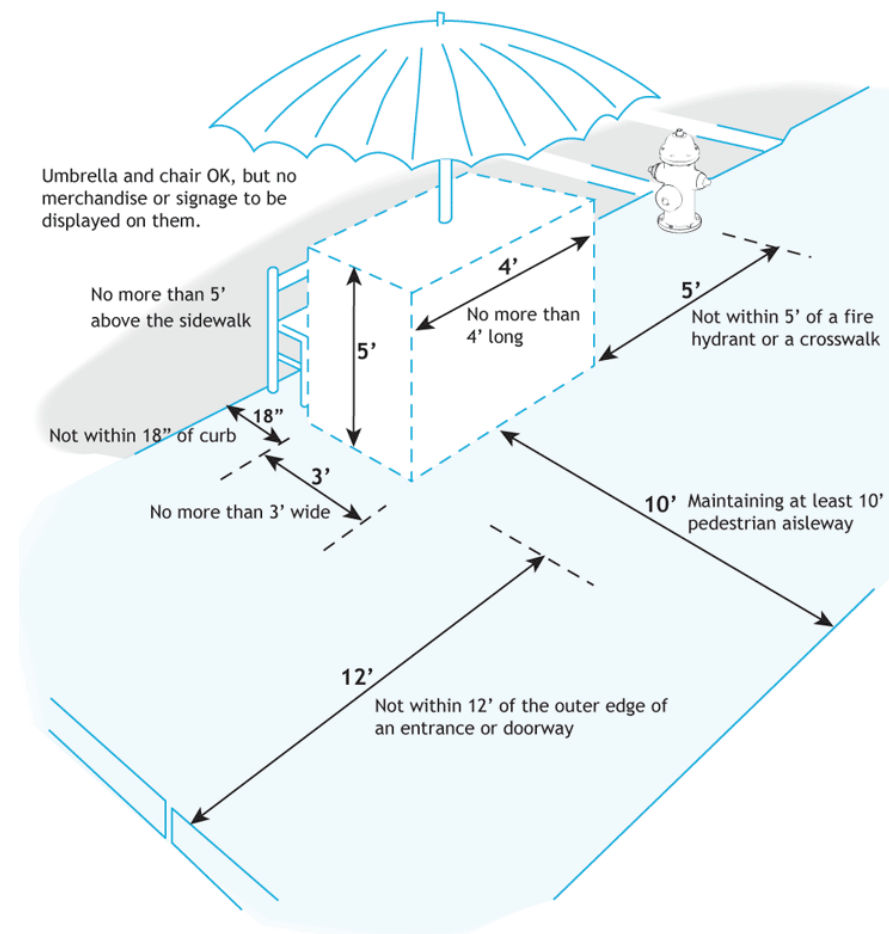
- not be within 5 feet of any crosswalk or fire hydrant;
- leave unobstructed fire escapes, underneath and perpendicular from the building to the street, 5 feet from both ends of the fire escape; and
- not be within 5 feet of inflammable liquid vents and fill pipes when tanks are not being filled nor within 25 feet while tanks are being filled.

**Street artists**

The street artists program licenses artists to sell their work on city streets. Street artists are permitted through the Arts Commission. Artists must present their work to a screening committee, obtain a certificate licensing them to sell their work, and participate in a lottery to see which spaces they will occupy. The Board of Supervisors sets appropriate locations for street artists.

Per pushcart and peddler requirements, street artist booths must adhere to the following dimensions:

- booths may be no more than 3 feet wide, 4 feet long, and 5 feet high;
- booths may not be within 18 inches of the curb;
- booths may not be within 5 feet of a fire hydrant or crosswalk;
- booths may not be within 12 feet of the outer edge of an entrance or doorway;
- booths must maintain at least 10 feet clear pedestrian pathway.



▶ Basic dimensional requirements for street artist displays

Source: San Francisco Arts Commission



## Traffic and parking signs

Traffic and parking signs convey essential information to drivers, cyclists, and pedestrians. However, if misplaced or overused, they may become too numerous, create a cluttered streetscape environment, and lose their efficacy as signage.

### *Location and placement*

Traffic and parking signs should be located in the edge zone. They should be placed at either end of parking stalls, and aligned along the block.

Traffic and parking signs should not be placed so that they will be obstructed by other streetscape elements. However, other desirable elements such as street trees or light poles should not be moved to accommodate new signage;

rather, signs should be placed around existing features and around the ideal locations of plantings, lighting, and site furnishings.

Signs may be placed within planters as long as they are concrete-set.

### *Consolidation*

Traffic and parking signs should be consolidated onto single poles wherever possible. New signs should use existing poles wherever possible. Stand alone signs should only be located where no other sign exists within 100 feet.

When redesigning streets, designers should look for opportunities to consolidate existing signage onto shared poles.

## Trash receptacles

### *Location of trash receptacles*

Trash receptacles should be located according to the following guidelines:

- Trash receptacles should be located near as near to corners as is practicable but out of the corner clear zone.
- They should be located near high activity generators such as major civic and commercial and transit destinations.
- There should be a maximum of one trash receptacle every 200 feet along commercial streets. Additional trash receptacles should be provided only if a private sponsor provides continued maintenance.
- A maximum of four trash receptacles should be provided at an intersection (one per corner).

### *Design of trash receptacles*

When selecting trash receptacles, they should be considered as a design element, and design should reflect aesthetic as well as functional concerns.

Trash receptacles should be selected from the same or a similar design “family” as other site furnishings (such as benches, bollards, bike racks, etc.) and should be finished or painted to complement other site furnishings.

Trash receptacle construction should use durable, high-quality materials, such as galvanized or stainless steel. Materials should be painted to reflect colors similar to nearby elements. Material and paint selection should be graffiti resistant.

Trash receptacles should include recycling containers and should be able to open from the side to allow easy access for removal of garbage bags.



◀ Trash receptacles should be conveniently located near high pedestrian traffic areas







# Utilities and Driveways

## 6.6

### Utilities

Utilities in the streetscape consist of utility poles and overhead wires, surface-mounted utility boxes, utility mains, laterals, vaults, and valves. They include sewer, water, gas, and telecommunications, as well as traffic signals, street lights (discussed in Section 6.3), and Muni poles and wires.

Utility installation can occur as a new installation (on new streets or as a part of new development), retrofit or upgrade to an existing system (such as undergrounding of overhead wires or sewer upgrades), or emergency repair. Utility installations, upgrades, consolidation, rearrangements, or realignments may also occur as part of other street or sidewalk improvement projects.

Utilities are a necessary and ubiquitous element of streetscape environments. Though essential, utilities often constrain the ability to locate other streetscape elements and can create a cluttered visual environment. Conversely, other streetscape elements may conflict with the ability to access and maintain utilities.

Well-organized utility design and placement can lead to:

- minimization of streetscape clutter to achieve a cohesive streetscape design;
- maximization of space for plantings;





- improved efficiency of utilities and integrated alignment with stormwater facilities, street furnishings, and street lighting;
- reduced cutting and trenching;
- possible reduction of long-term street and sidewalk closures;
- reduced long-term maintenance conflicts and potential costs; and
- improved pedestrian safety, quality of life, and right-of-way aesthetics.

## GUIDELINES

### Locating Utilities

Utilities should be placed to minimize disruption to pedestrian through travel and potential planting and site furnishing locations while maintaining necessary access for maintenance and emergencies, per the following guidelines:

**Roadway/Parking Lane:** Large utility vaults such as network or transformer vaults, and conduits running the length of a city block, should be located in the roadway or parking lane where access requirements allow. Vaults in the parking lanes should be striped as a temporary parking area, in a no parking zone, or in front of driveways.

Utility vaults located in the street must be rated to City loading standards based on expected use and vehicle type.

**Edge zone:** Small utility vaults such as residential water vaults, residential water meters, gas valves, gas vaults, or street lighting should be located in the edge zone wherever possible to minimize conflicts with existing or potential tree locations. Vaults should be aligned or clustered wherever possible.

Generally, utility boxes are sited in the direction of the pipe.

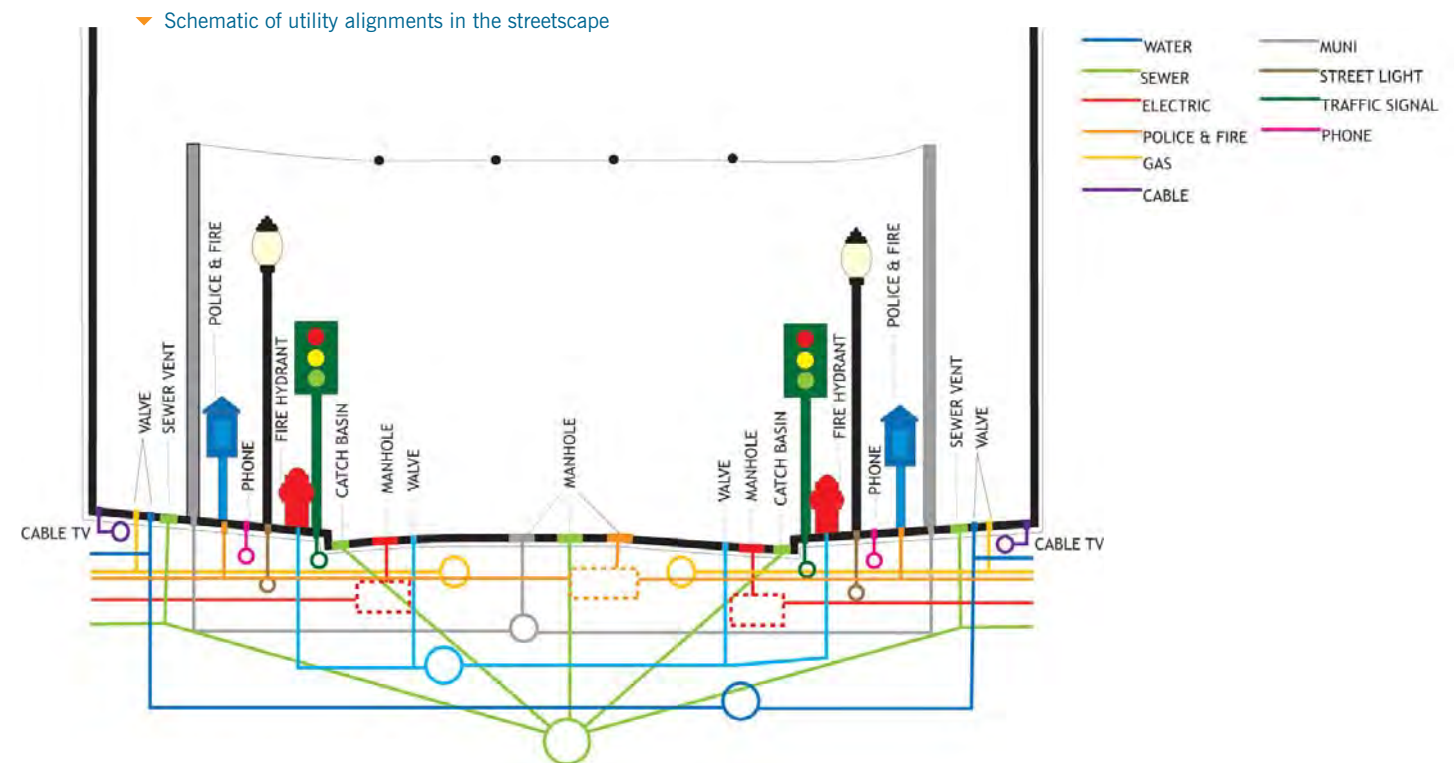
- Utility boxes that are parallel with the curb should be located in the edge zone or throughway zone where possible, or between existing or potential street tree or sidewalk landscape locations.
- Utility boxes that are perpendicular to the curb should be located between existing or potential street tree or sidewalk landscape locations, such as where pass-throughs to parked cars are placed.

**Furnishings zone:** Utility vaults and boxes should be located outside of the furnishings zone wherever possible to maximize the number and size of tree wells and the ability to connect tree wells into continuous strips.

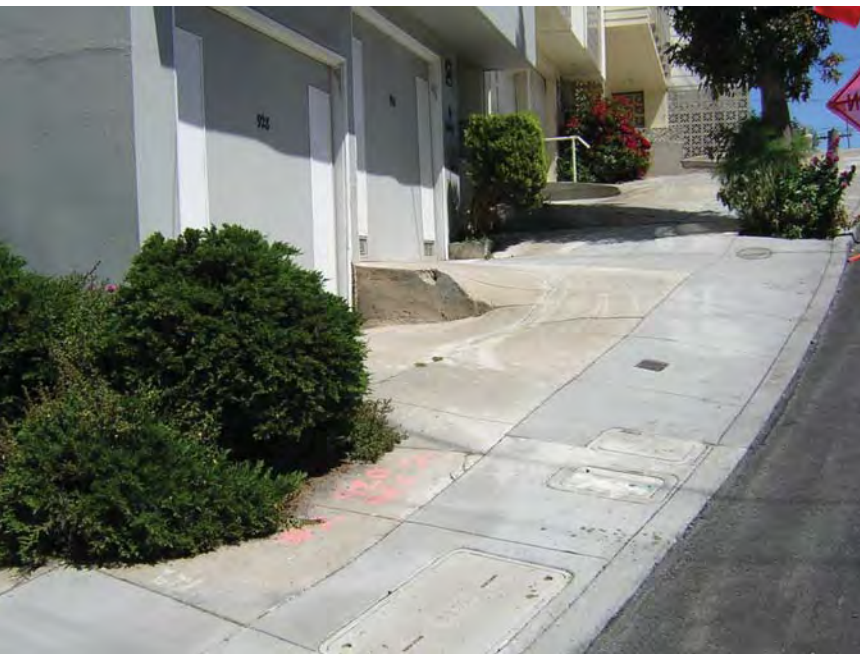
Utility laterals should run adjacent to, not directly under, potential site furnishing and tree planting locations wherever possible (such as through driveways or between tree



▲ Utilities are often scattered in the sidewalk without consideration for the overall streetscape environment







▲ Many streets have few or no trees for entire block lengths because subsurface utilities limit the ability to plant



▲ Utility vaults may be located within planting areas as long as access is maintained

Figure 6.11. Appropriate Utilities by Sidewalk Zone

	SMALL UTILITY STRUCTURES								LARGE UTILITY STRUCTURES					
	Sewer Vents	Sewer Clean-outs	Water Valves	Water Vaults	Water Meters	Gas Valves	Gas Vaults	Street Lighting (Vaults)	Utility Laterals	Irrigation Lines	Utility Conduits	Large Electrical Utility Vaults	Large Telephone Utility Vaults	Combined Dry Utility Vaults
Edge Zone	●	●	●	●	●	●	●	●	●	○	○	×	×	○
Furnishings Zone	○	○	○	×	×	○	×	○	○	○	○	×	×	×
Throughway Zone	○	○	○	○	○	○	○	○	○	●	●	●	●	○
Frontage Zone	○	○	○	○	○	○	○	○	○	○	○	×	×	○
Corner Zone	×	×	×	×	×	×	×	○	×	×	×	×	×	×
Curb Extensions and Parking Zone	×	×	×	×	×	×	×	○	×	○	×	×	×	×
Streets	×	×	×	×	×	×	×	×	×	×	●	●	●	●

● Preferred ○ Acceptable × Not Recommended

basins). Subsurface utility conduits and irrigation lines should avoid running under the length of the planting area to minimize root interference. Water meters should also be located outside this zone where possible to avoid interference from tree roots. Street trees should maintain adequate clearance from water meters to avoid damage to the meter from tree roots.

If several shallow utility laterals are unavoidable, planting areas may still be created and should utilize ground cover or low shrub plantings without the incorporation of deep rooted trees, per Section 6.1.

Surface-mounted utilities may be located in the furnishings zone, per DPW Director’s Order #175,566. Surface-mounted utilities such as hydrants and air valve enclosures must be set on a concrete base if located within planted areas

**Throughway Zone:** Utility vaults and conduits running the length of the city block may be located in the throughway zone. Vaults in the throughway zone should meet DPW Director’s Order #176,112 guidelines for slip-resistant covers.

Large utility vaults should be placed at least 3 feet from building and 4 feet from curb where sidewalk widths allow.

Surface-mounted utilities should not be located in the throughway zone.

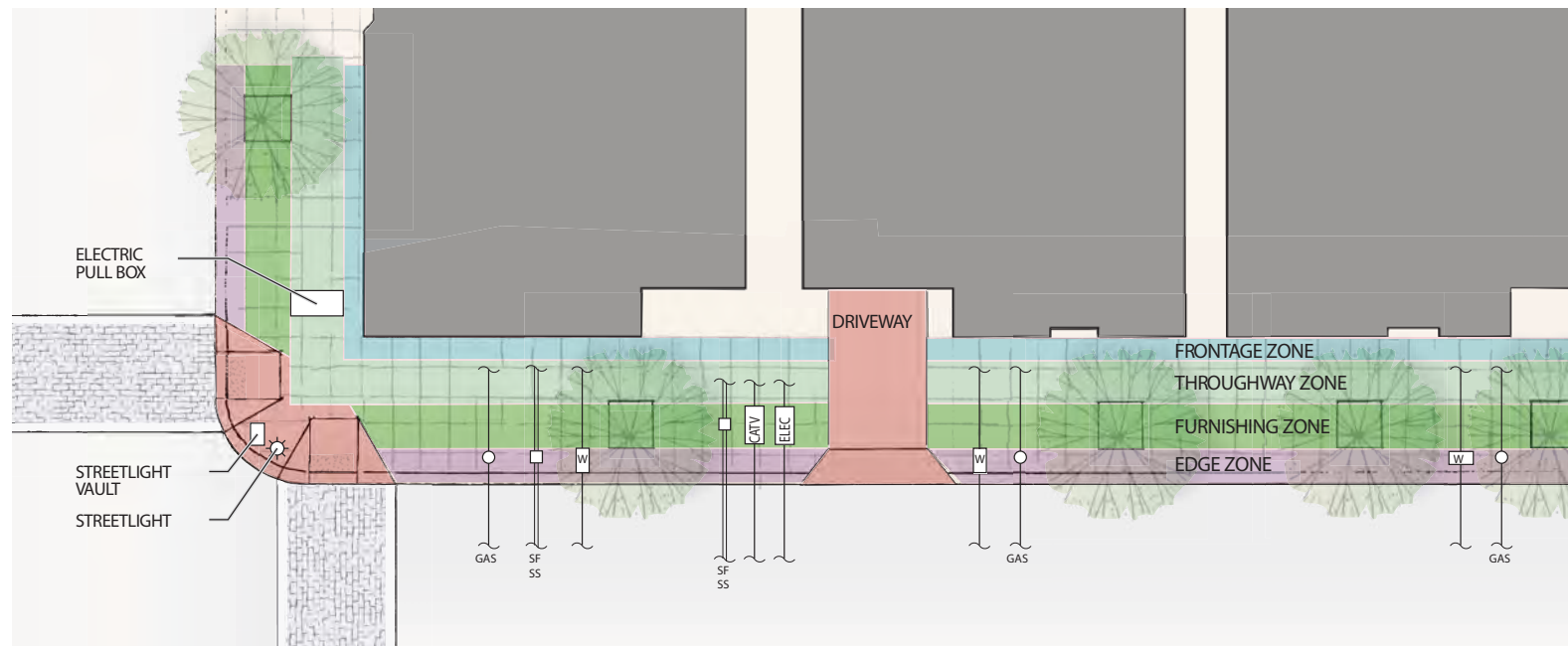
**Frontage Zone:** Utility vaults and valves may be placed in the frontage zone. Placement of utility structures in this zone is preferred only when incorporating utility vaults into the edge zone is not feasible.

Utility vaults in the frontage zone should not be located directly in front of building entrances.

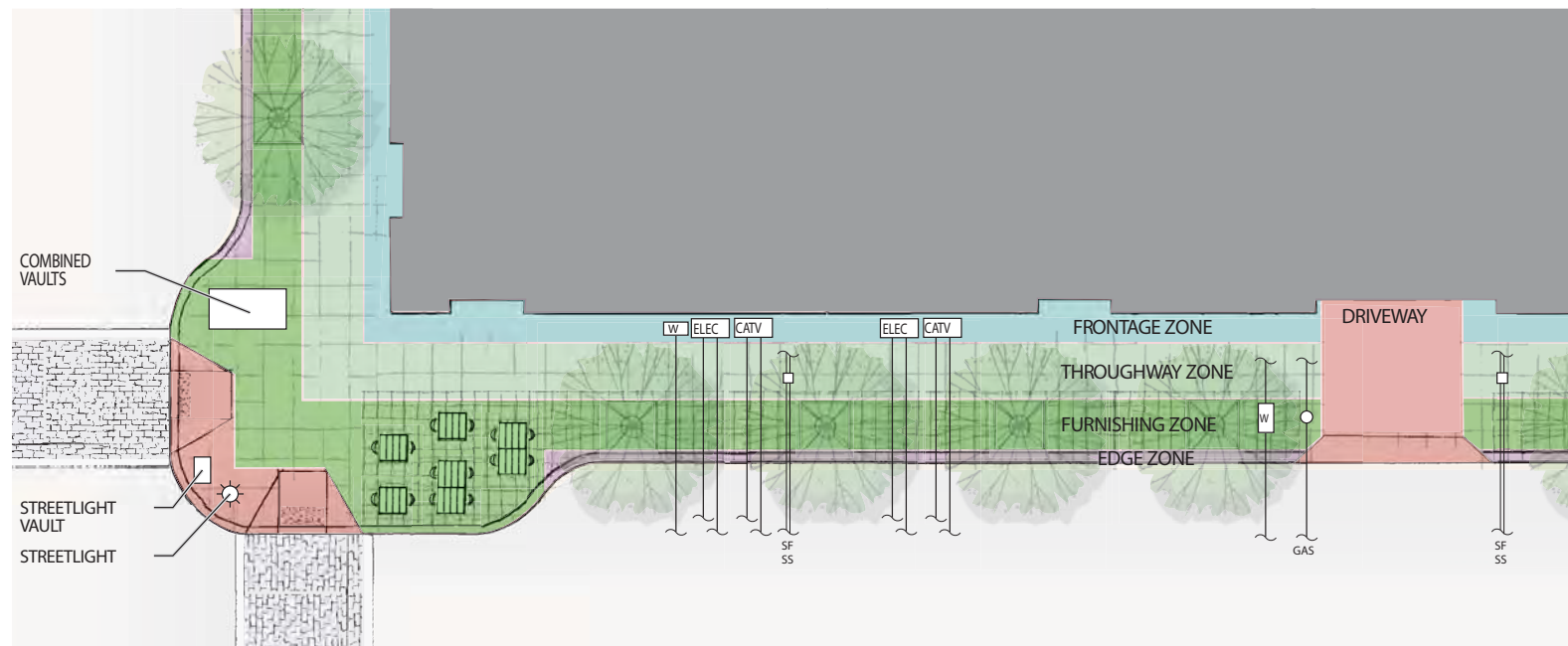
**Extension Zone:** Utility vaults and valves should be minimized in curb extensions where plantings or site furnishings are desired.

Surface-mounted utilities may be located in curb extensions outside of crossings and curb ramp areas to create greater pedestrian through width.

Utility mains located in the parking lane and laterals accessing properties may pass under curb extensions.



Recommended Utility Locations for Residential (Neighborhood and Throughway) Street Types



Recommended Utility Locations for All Other Street Types (Including Downtown Residential)

**NOTE:**  
Utility locations are for representation only and should be placed per City and County of San Francisco Standards and PG&E Greenbook Standards.



### → Utilities Permitting in San Francisco

Public utilities (e.g. PG+E, Comcast, ATT, etc.) all have franchise agreements with the state and do not require a city encroachment permit; however, they require an excavation permit and are subject to the Excavation Code (DPW Director's Order #176,707), and Surface-Mounted Utility guidelines (DPW Director's Order #175,566).

Privately installed utilities do not fall under the state franchise agreements and are required to get a major encroachment permit for significant streetscape or capital improvement infrastructure projects.

City utilities (water, sewer, street lighting, and traffic signals) need an excavation permit but not an encroachment permit.

The Fire Department does not require a permit from Bureau of Streets and Mapping for water infrastructure.

With curb extensions or sidewalk widenings, utilities such as water mains and meters, or sewer vents may remain in place as it may be cost-prohibitive to move them per the SFPUC “Bulb-out and Sidewalk Widening Guidelines for Water and Sewer” and SFPUC review.

**Driveways:** Utility laterals and vaults should be located so as to avoid potential street tree and sidewalk landscaping locations. Particularly in instances where there are frequent driveways, alternate locations for utilities should be sought so as not to take up available street tree planting locations. Utility boxes may be located in driveways if the sponsor provides a vehicle-rated box; however, this is not a preferred solution due to access difficulties.

**Pedestrian Crossings and Curb Ramps:** New utility structures should not be placed within street crossing and curb ramp areas wherever possible.

If existing vaults conflict with ramp areas, vaults should be moved or modified to meet accessibility requirements as feasible as part of utility upgrades.

Catch basins and surface flow lines associated with storm drainage systems should be located away from the crosswalk or between curb ramps. On new streets, catch basins should be located upstream of curb ramps.

### Consolidation

Utilities should be consolidated for efficiencies and to minimize disruption to the streetscape, per the following guidelines:

- Dry utility lines and conduits (telephone, CATV, electric, and gas, etc) should be initially aligned, rearranged or vertically stacked to minimize utility zones. Designers should refer to the Typical Distribution Trench schematic (from PG&E) for placement of joint utilities within a public utility easement.

- Wherever possible, utility conduits, valves, and vaults (e.g. PG&E, or street lighting and traffic signals) should be consolidated if multiple lines exist within a single street or sidewalk section.
- Dry Utilities (gas, telephone, CATV, primary and secondary electric, streetlights) should use shared vaults wherever possible. Shared vaults should be installed with predetermined color coded conduits per predetermined city standards with a consideration for future public and private conduits. Private companies would have the option to purchase from the City or Utility any unused networks of existing conduit in-lieu of installing a new a separate conduit route along a constrained street.
- Fiber optic lines can be installed within active sewer trunk lines to minimize trenching.
- Surface-mounted utilities should share boxes wherever possible.
- Street lighting, traffic signal, and MUNI catenary poles should share poles wherever possible, and wherever doing so would not significantly alter the placement of these elements per the guidelines in other sections of this document. When retrofitting existing streets or creating new streets, pursue opportunities to combine these poles.

### Design Guidelines

Street design and new development should consider overall pattern of plantings, lighting, and furnishings when placing new utilities in the street, and locate utility lines so as to minimize disruption to the prevailing streetscape rhythms per the following guidelines:

- Utilities should be located underground wherever possible, as opposed to overhead or surface-mounted.
- New utilities should use durable pipe materials that are resistant to damage by tree roots, such as ductile

iron, polyethylene, or polypropylene pipes. The preferred material for water pipes is ductile iron.

- New utilities should use pipes with minimal joints.
- Utility vault covers should be made of slip resistant materials, per DPW Director’s Order #176,112.
- The City should pursue the use of “trenchless” technologies, such as sealants, pulling cables through tunnels, etc. wherever possible, to avoid excavation and disruption of streetscape elements.
- New infrastructure projects should use resource-efficient utility materials, such as recycled PE conduit instead of PVC conduit, as stock materials deplete. Re-used or recyclable materials should be incorporated wherever possible.

- Tree removal should be avoided and minimized during the routing of large-scale utility undergrounding projects
- Any utility-related roadway or sidewalk work should replace paving material in-kind (e.g. brick for brick) where removed during emergency or construction per DPW Director’s Order #176,707, Section 12.4B. (Pavement made of special materials shall be restored in kind.)
- Where landscaped medians are realigned or created during a major street improvement project, existing combined sewer manholes should be raised (6 inch above finish grade) to form an overflow drain inlet within a depressed planted median. This would create a stormwater facility using the existing infrastructure. Catch basin laterals may then be removed as allowable.

### Access and Maintenance

Major utilities (sewers, fire hydrants, gas and water meters and mains, manholes and utility vaults, and utility poles) should be installed at least 5 feet from the edge of existing or proposed tree basins.

Minor utilities (laterals, vaults, valves, etc) should be installed at least 3 feet from the edge of new or existing tree basins.

Utility Poles should be accessible by a 3 foot path.

Refer to City and County of San Francisco Standard Plans and Excavation Code (DPW Director’s Order #176,707) for utility installation standards.

### ➔ Screening of Surface-Mounted Utilities

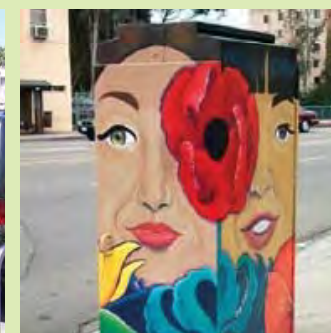
Surface-mounted utilities are often bulky and unattractive elements in the streetscape. Where possible, they should be located outside of the right-of-way and screened within private parcels. However, in many cases, they will be located in the public right-of-way. To that end, they should minimize their negative visual impact.

Surface-mounted utilities (SMUs) require an excavation permit from the Department of Public Works, and must comply with DPW Director’s Order #175,566. In addition, when located in the public right-of-way, SMUs should be screened per the following:

- SMUs should be painted a neutral color to blend in with background street elements. Alternatively, they may be considered an artistic element in themselves, and boldly painted as part of public art in the streetscape.
- Where sidewalk dimensions allow, SMUs should be screened by elements appropriate to the particular street type.
  - For example, on residential streets, they may be buffered on either side and behind by sidewalk plantings with tall, leafy shrubs. Sidewalk plantings should adhere to the guidelines in Section 6.1, and should fit in with the overall planting palette of the street. Buffer plantings should generally be 6 to 24 inches in width, and should retain access to the front of the cabinet.
  - On commercial or mixed-use streets, SMUs may be screened by low seating walls, artistic screens, or other elements. Plantings might be incorporated through vertical metal lattices with climbing vines to screen the utility boxes.



Surface-mounted utility boxes: unadorned and painted as part of a public art program (from San Diego)







▲ Overhead utility wires detract from the aesthetic experience of the streetscape

## ➔ Utility Undergrounding in San Francisco

Community members often cite utility undergrounding as one of the top priorities for street improvement. When undergrounding occurs, placement of utilities should follow the guidelines in this section to minimize disruption to the overall streetscape design. The bigger challenge with utility undergrounding is the ability to pay for an on-going program of undergrounding.

To address this challenge, the Board of Supervisors created the Utility Undergrounding Task Force (UUTF) in 2004, consisting of 15 appointed voting members, and staff from City agencies and utility providers, to advise the Board on the future of utility undergrounding in San Francisco. The UUTF presented a final report to the Board of Supervisors on January 26, 2007.

To paraphrase the UUTF final report:

### BACKGROUND

In 1996, the Board of Supervisors legislated the undergrounding of forty-two miles of overhead utility wires (subsequently expanded to 45.8 miles). After completing those 45.8 miles, San Francisco will have undergrounded 520 miles of overhead wires out of 990 miles, leaving 470 miles remaining.

The main obstacle in continuing to underground the City's utilities is a lack of funding. Utility undergrounding in California is primarily funded by two sources, known as Rule 20A and Rule 20B, both overseen by the California Public Utilities Commission (CPUC). Rule 20A funds are paid 90% by utility providers (such as PG+E), and 10% by the City and County. San Francisco has received an average of \$6 million in Rule 20A funds, enough to pay for about 1.5 miles of undergrounding per year. However, as of 2007, San Francisco had borrowed twelve years into the future for Rule 20A funds.

Rule 20B funds are shared by utilities and property owners, typically through special Community Facilities Districts (Mello-Roos Districts); the property owner share may also be borne by the City. San Francisco has not generally used Rule 20B funds; however, the opportunity to use these funds exists.

### RECOMMENDATIONS

The UUTF recommended the following City actions:

1. Develop a long-term master plan and a properly funded program to underground all utility wires within fifty years.
2. Create a transparent community process that involves residents in the decision-making process.
3. Request the CPUC to approve an electric/natural gas surcharge for San Francisco residents.
4. Seek alternative funding sources for utility undergrounding.
5. Establish a City policy of no new overhead utility wires.
6. Implement a utility undergrounding program that reduces current project timelines by 50% and project costs by 25%.

The City is currently exploring ways to continue to fund undergrounding efforts in San Francisco.

For more information on the report on undergrounding in San Francisco, see:

[http://www.sfgov.org/site/sfdpw\\_page.asp?id=32694](http://www.sfgov.org/site/sfdpw_page.asp?id=32694)

Source: Utility Undergrounding Task Force Report to the San Francisco Board of Supervisors, January 26, 2007

### New Development and Major Redevelopment

Within new development and major redevelopment areas:

- Where appropriate, the City should support the installation of separate stormwater and wastewater collection systems in areas where not already implemented by SFPUC.
- New residential development areas should incorporate alleys for vehicle, utility, and service access so as to enable a more consistent streetscape and minimize above-ground utilities.
- New development should locate new utilities to minimize disruption to streetscape elements per guidelines in this section.

### Abandonment

Currently abandoned dry conduits should be reused or consolidated if duplication of lines are discovered during street improvement projects. Utilities should be contacted for rerouting or consolidation.

Where it is not possible to reuse abandoned mains, conduits, manholes, laterals, valves etc., they should be removed per agency recommendations when possible in order to minimize future conflicts.

Abandoned water and sewer lines may be retrofitted as dry utility conduits where available or if possible to minimize the need for future conduit installations.

### Process

Utilities should be installed during a full-street, half-street, or full or partial sidewalk improvements rather than as a separate utility cut wherever possible.

New development should submit utility plans with initial development proposals so that utilities may be sited to minimize interference with potential locations for streetscape elements.

Utility installation or repair should be conducted from the bottom up; scheduled utility installation or repair should occur prior to planned street reconstruction or major streetscape improvements.

The City should use major utility work as an opportunity to build streets back to desired conditions, per Better Streets Plan guidelines.

### → Best Practice: New York City High Performance Infrastructure Guidelines

New York, New York

The New York City High Performance Infrastructure Guidelines provide a roadmap for incorporating street wide best management practices (BMPs) into New York City's right-of-way infrastructure capital program. They are written for the Department of Design and Construction, but they are just as useful for by planners, designers, engineers, public officials, and all other services involved in constructing, operating, or maintaining the right-of-way.

The guidelines act as the first step toward improving design collaboration while enhancing environmental, social, and economic outcomes for the City's infrastructure investments.

See <http://www.nyc.gov/html/ddc/html/ddcgreen/highperf.html>



## Driveways

Driveways allow necessary access across the sidewalk to residential and commercial garages. Too many driveways are a negative presence in the pedestrian environment, as they present potential conflicts between drivers and pedestrians and increased possibility that pedestrian through travel will be compromised.

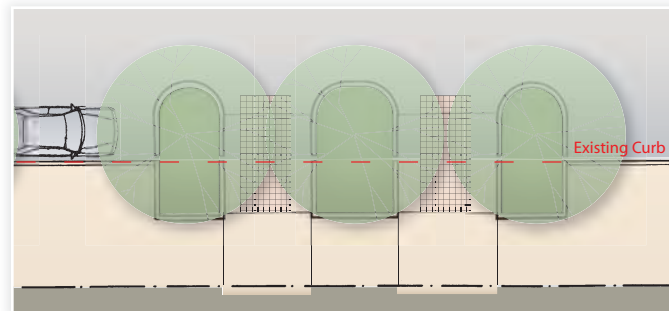
In many areas, the high number of driveways and width of driveway curb cuts reduces the available space for planting and other amenities. Improved driveway design can provide added space for planting to improve street aesthetics.

### GUIDELINES

Driveways should be designed to minimize impact on through travel or pedestrian use of the sidewalk.

Driveway curb cuts for individual residential properties should not be wider than 7 feet with 1 1/2 foot wings (10 feet total width). Where truck loading is the dominant activity, they should not be wider than 8 feet with 1 1/2 foot wings (11 feet total).

Driveway curb cuts for two-way traffic should not be wider than 18 feet. An exception should be made on industrial



- ▲ Parking-lane planters can be located between driveways where space is too narrow to allow a vehicle to park. Where planters extend into the sidewalk furnishings zone, they can be designed to occupy the space of driveway wings, narrowing the driveway and widening the planting area.

streets in locations requiring frequent access for large trucks or semi-tractor trailers, where two-way driveway curb cuts may be up to 24 feet in width.

DPW standard plans for driveways should be consulted for engineering standards for driveway construction.

Curb cuts are discouraged in pedestrian-intensive areas. Reducing driveways reduces the number of conflict points between pedestrians and vehicles and can dramatically improve safety.<sup>1</sup>

Wherever possible, commercial, industrial, and large residential properties should consolidate driveways by interconnecting parking lot and loading area entries and by sharing parking among uses.

In areas of San Francisco where alleys provide access to the rear of properties, curb cuts onto streets are strongly discouraged; all parking and service access should be provided via the alley.

On new streets, alleys should be provided, minimizing the need for new driveway cuts on primary streets.

Because driveways handle relatively low volumes of traffic, alternative surfacing materials including unit pavers and other permeable materials may be installed in driveways where frequent heavy trucks are not expected to cross over. The clear throughway zone of the sidewalk should be a continuous material.

Driveways may be bounded by permeable paving, curb extensions or landscaping areas that extend from the sidewalk into the parking lane, eliminating the need for driveway aprons.

<sup>1</sup> Source: <http://www.ctre.iastate.edu/research/access/toolkit/3.pdf>. See also pages 11-13 of the following document: [www.ctre.iastate.edu/PUBS/tsinfo/1-6.doc](http://www.ctre.iastate.edu/PUBS/tsinfo/1-6.doc)





# CHAPTER

和益珠寶行

WO YICK CO. FINE JEWELRY

PHOTO & ELECTRONICS

Canon  
MINOLTA  
PENTAX  
OLYMPUS

PORTLAND CAMERA SHOP

OPEN

茶

國產茗茶

南海

NAM HA



CHAPTER

# 7.0

IMPLEMENTATION

- 7.1 Identifying Priorities
- 7.2 Maintenance
- 7.3 Funding
- 7.4 Education and Enforcement

# IMPLEMENTATION

*Achieving the vision of the Better Streets Plan will rely on the ability to effectively fund, build and maintain improvements, and to sustain improvements over time.*







# Implementation

## 7.0

To implement the vision of the Better Streets Plan, the City must consider how to make these improvements happen, and how to sustain improvements over time. Identifying desired street design concepts is merely the first step to making them real; the City must also identify strategies for on-going funding, efficient and effective maintenance practices, and pedestrian enforcement and education campaigns.

This chapter describes preliminary ideas about how to implement Better Streets improvements. Some additional next steps are described in Section 1.3: Moving Forward. Other proposed next steps are called out in Chapter 3: Goals and Policies.

Additionally, the Better Streets team engaged the Controller's Office to evaluate current street design practices and offer recommendations to make the system more comprehensive and efficient. Their final report recommends ways for the City to improve its street design process to help implement the Better Streets Plan, and is available at [www.sfbetterstreets.org](http://www.sfbetterstreets.org).



Planting the medians on Guerrero Street  
Courtesy of San Jose/Guerrero Coalition

Consistent with the Controller's Office recommendations, the City has begun to implement the following changes:

- An inter-agency "Street Design Review Team" will be established to provide policy-level review of major projects, whether initiated by public or private sponsors, to determine the degree to which each project meets the City's objectives for the design and use of streets as spelled out in this plan and other documents.
- An inter-agency "Streetscape Capital Group" will be established to conduct advance planning for capital street improvements, building on existing City resources and data, to maximize funding opportunities and to coordinate improvements and expenditures planned by agencies.

The City will test this new approach by selecting certain pilot projects to measure success, and to make further adjustments as necessary. The Controller's Office report contains many other recommendations, such as providing a design checklist for project managers within agencies and improving customer service to facilitate and encourage community-led projects. The City will review and implement these recommendations as appropriate.

### See the Controller's Office report:

*"Better Streets Plan: Recommendations for Improved Streetscape Project Planning, Design, Review, and Approval,"*

available at [www.sfbetterstreets.org](http://www.sfbetterstreets.org)

## 7.1 IDENTIFYING PRIORITIES

To help implement the Better Streets Plan, the City is working to identify priority criteria for pedestrian and streetscape improvements. These criteria would be used to prioritize projects for capital funding, including transportation sales tax dollars, external grants, and other funding sources. Priority criteria for street improvements may include the following pedestrian-oriented criteria:

- **Areas with especially high collision/crash rates:** Pedestrian safety is a prime objective of the Better Streets Plan. Areas with high incidences of pedestrian safety issues should be prioritized for improvement.
- **Transit Hubs:** San Francisco is a "Transit-First" city, with large volumes of commuters, visitors and residents traveling around the city on public transit. Pedestrian volumes are concentrated at major transit hubs (stations, bus stops, transfer points, transit centers, and regional transit facilities), and stress levels are often high as complex transit connections are often made. Improvements should be prioritized at and around key transit locations to enhance the experience and safety of walking to a transit trip, supporting the City's Transit-First Policy.
- **Schools, child care centers, senior centers, and senior housing:** The areas around these facilities are more likely to be populated by pedestrians of age-specific vulnerability. Application of Better Streets Plan recommendations in these areas will help ensure that the vulnerability and exposure of these populations is given more attention, and encourage walking as a safe mode of travel by these populations.

- **Neighborhoods with sub-standard infrastructure:** As neighborhoods develop at different rates and with differing land uses, certain neighborhoods are in greater need of high-quality infrastructure investment than others. Streetscape and pedestrian improvements should be prioritized in these areas to ensure more equitable distribution of resources, both geographically and economically.
- **Accessibility gaps:** Areas that have sub-standard infrastructure for accessibility features should be prioritized per the ADA transition plan for sidewalks and curb ramps.
- **Areas with high population densities and/or intense mixes of land use:** Areas of concentrated land use and population, such as downtown or commercial areas, generally produce higher numbers of pedestrian volumes, as more people are inclined to walk as a primary mode of travel; hence, they deserve greater concentrations of pedestrian facilities and amenities.
- **Areas with significant regional and local destinations:** Similarly, people are attracted to large centers of regional and local activity, such as tourist destinations, recreational facilities, large institutions, and cultural attractions. These institutions are often dependent on the pedestrian networks that link them to transit facilities and concentrated points of origin, and often people walking in these areas are unfamiliar with local travel patterns and the city's overall landscape.



- **Areas of ecological connection or concern:** Streets can serve as green corridors through the city, connecting larger parks and open spaces with a swath of green, and providing habitat for small wildlife. Particular areas may also be prone to flooding or other environmental issues. Streets that provide these connections or have significant environmental issues should be prioritized for improvements.
- **Streets that are important to the city pattern:** The San Francisco General Plan identifies streets that contribute to the city pattern—streets that are most useful in creating a distinctive urban design and recognizable image for San Francisco, clarifying routes for travelers, and contributing to the overall legibility of the city as a whole.
- **Opportunities to leverage other projects:** The City has limited funding to make streetscape and pedestrian improvements. This funding should be leveraged by piggy-backing on existing capital infrastructure projects, such as re-paving projects or utility upgrades to realize cost efficiencies and create more complete street improvements.

## 7.2 MAINTENANCE

When contemplating the pieces that must come together to make great streetscapes a reality, it is easy to overlook management and maintenance considerations. Yet those functions will determine San Francisco's ability to not only deliver streetscape improvements but also sustain them into the future.

Many of the design concepts described in this plan go beyond the standard streetscape treatment given to San Francisco streets today, requiring different or additional maintenance than current practice provides. This is not to say such features are difficult or impossible to maintain—indeed, the concepts shown in this document are used by cities throughout the country today. Rather, the City must consider its maintenance practices as a whole to incorporate new desired street designs, and explore innovative maintenance practices to address them.

The Better Streets team hired a consultant team led by Community Design and Architecture to make initial recommendations for how the City can improve its streetscape maintenance practices. Their final maintenance memo is available at [www.sfbetterstreets.org](http://www.sfbetterstreets.org). In addition, the Controller's Office through their work will be further developing streetscape maintenance recommendations, including the development of a life-cycle cost model for streetscape features. This report was published in November 2010 and is available at the Controller's Office website. Primary areas of investigation include:

- identifying and developing alternative funding sources for street maintenance, such as community benefit districts, parking benefit districts, private 'adopt-a-street' sources, and the like;
- exploring and developing community stewardship models and programs;
- clarifying streetscape and sidewalk maintenance responsibilities between property owners and the City, and exploring programs that enable the City to take on maintenance of these features to take advantage of economies of scale;
- considering life-cycle costs of streetscape materials and designs, and accounting for full costs and benefits of streetscape improvements. For example, stormwater management features may add routine maintenance in the short-term, but may require less infrastructure costs to the City in the long-term;
- exploring opportunities for long-term, dedicated maintenance funding associated with capital projects; and
- minimizing deferred maintenance so as to spend more on routine maintenance than on rehabilitation or reconstruction. Experience has shown that it is usually most cost-effective to allocate funding to routine maintenance; this extends the life of infrastructure while helping to delay or prevent the need for more costly rehabilitation or reconstruction.

### 7.3 FUNDING

To realize the street improvements proposed by the Better Streets Plan in a systematic manner across the city, the City must commit to a significant investment in street improvement projects. The City should aggressively pursue federal and state grant opportunities for Better Streets projects. New funding sources, such as public/private partnerships, developer requirements, bond measures, and others should be considered.

The City should also look for opportunities to combine and create synergies among capital street improvement projects, such as by matching curb ramp funds with curb extension projects, merging traffic calming, greening, and stormwater projects, or prioritizing streetscape improvements when major capital work (e.g. sewer upgrade, repaving) will take place.

See the Controller's Office report at [www.sfbetterstreets.org](http://www.sfbetterstreets.org) for additional streetscape funding recommendations.

### 7.4 EDUCATION AND ENFORCEMENT

Education and awareness campaigns regarding pedestrian safety and activity are essential to successfully implementing Better Streets Plan ideas. Pedestrian education and enforcement efforts should work in tandem to promote safe use of streets and encourage walking – they are more effective when combined. For example, a campaign may institute a progressive ticketing procedure for enforcement: 1) first educate (such as by holding an awareness day), 2) warn, then 3) ticket.

Education and enforcement policies and campaigns should:

- focus on conditions which affect high-risk populations, including seniors, children, and people with disabilities;
  - focus on streets and routes which carry heavy and speeding traffic, particularly those streets in low-income residential areas;
  - focus on schools by developing a comprehensive Safe Routes to School Program. Safe Routes to School is a national and international movement to create safe, convenient, and fun opportunities for children to bicycle and walk to school. It helps improve health, reduce traffic congestion, improve air quality, and enhance neighborhood safety for children and their communities;
  - continue to build the capacity of neighborhood and community groups to advocate for pedestrian improvements in their neighborhoods and citywide through mini-grants and technical assistance;
  - use media campaigns as an adjunct to community-based awareness campaigns, rather than as stand-alone tools. Media campaigns can help change and reinforce community norms and values, in the context of on-going education and policy interventions that have visible community support;
- secure long-term funding streams for educational and encouragement efforts in order to conduct long-range efforts that are consistent and persistent; and
  - involve community groups, activists, residents and public agencies. Long-term involvement by these groups is necessary for priorities to be set, plans implemented, interventions reviewed, and problems resolved.

#### General strategies

The City should create a shared database that can be accessed by all departments. This database should include traffic statistics and collisions, walking exposure numbers (in order to calculate rates), and other information. Currently, multiple departments use their own statistics and interpret them differently. A shared database would promote consistent interpretation of pedestrian safety data. This data would help the City to identify the most appropriate education and enforcement strategies given limited resources.

The City should promote on-going, consistent campaigns such as media outreach, pedestrian decoy stings, and the like. Currently, pedestrian education and enforcement efforts are done piecemeal, primarily through grant funding. Few campaigns are conducted on a regular basis. There is a need for stable funding sources such that campaigns can continue and create on-going efforts with greater impact.

City departments should collaborate with community-based organizations involved in pedestrian safety, including sharing of information and resources.



## Education campaigns

Education campaigns should be multi-pronged, sustained over long period of time, and relevant and appropriate to San Francisco. Public awareness campaigns should be based on analyses of traffic collision data. This can help the City concentrate efforts on a certain risk group or high-impact corridor. Campaigns may use media materials such as posters on transit vehicles and transit shelters, radio, television, and internet advertising, newsletters, and neighborhood association communications. Positive results should be publicized to the media.

Some creative pedestrian safety education campaigns may include:

- marking chalk outlines at the location of pedestrian collisions;
- providing incentives for good driver or pedestrian behavior, or for people to shift to walking as a mode of transportation; and
- instituting a “Don’t Block the Box” campaign (combined with enforcement) to keep drivers out of crosswalks and intersections at red lights.

Pedestrian education campaigns should also involve strategies to promote walking. These might include:

- media campaigns to promote walking;
- rewarding behaviors with incentives;
- institutionalizing the Safe Routes to School program;
- creating accessible walking maps and routes; and
- promoting organized activities such as the Walking Challenge, Walk to School Day, Sunday Streets, and the like.

## Enforcement Strategies

Effective enforcement of applicable regulations is crucial to promote pedestrian safety and sidewalk accessibility. The term ‘enforcement’ includes enforcement of traffic and pedestrian safety laws (found in the California Vehicle Code and San Francisco Transportation Code), with a focus on speeding, pedestrian right-of-way violations, and sidewalk parking, as well as Planning Code and Public Works Code violations such as sidewalk obstructions, required front yard landscaping, and others.

The goal of pedestrian enforcement should be to create a safe, comfortable space for pedestrians that encourages walking. Enforcement should be based on data analyses, to concentrate enforcement efforts where they are most needed, for particular at-risk populations, and at specific unsafe behaviors.

Enforcement efforts should include training of law enforcement officials (including law enforcement and judicial courts, crossing guards, and parking enforcement officers) on the rights and responsibilities of pedestrians and drivers. These entities should collaborate to ensure prosecution of failure to yield violations and reduce plea bargaining and downgrading of such offenses that has frequently occurred in the past.

Some enforcement strategies include:

- create a traffic complaint hotline, perhaps through 311;
- create a dedicated section of the Police Department for traffic enforcement only. Currently, enforcement staff are pulled between staffing special events, escorting dignitaries, and traffic enforcement;
- create and enforce double-fine zones to protect vulnerable groups, for example at schools;
- institute consistent, on-going pedestrian safety operations, such as the use of “decoys” or “stings.” These campaigns place a police officer in civilian clothes to cross in crosswalks where drivers typically ignore pedestrian laws, and cite drivers that violate the law;
- investigate possible community enforcement techniques such as neighborhood speed watch, pace car, and the like; and
- use technology to supplement staff enforcement (for example red light-running cameras or cameras mounted on street cleaning equipment).



E



# APPENDICES

GINA  
KHAN  
SALON

DIPTYQUE

173 GINA KHAN SALON

diptyque  
paris

MOCC



# AP

## APPENDICES

- A. Better Streets Policy
- B. Transit-First Policy
- C. “Complete Streets” Policy
- D. Summary of Community Involvement
- E. Summary of Accessibility Guidelines
- F. Glossary
- G. Summary of Physical Elements in the BSP

# A. Better Streets Policy

## SAN FRANCISCO ADMINISTRATIVE CODE

### CHAPTER 98. BETTER STREETS POLICY

#### Sec. 98.1.

*Better Streets Policy; Governing Principles;  
Coordination Of Departmental Actions.*

- (a) The Better Streets Policy is an official policy of the City and County of San Francisco and shall read as follows: Design City streets in keeping with the Urban Design Element of the City's General Plan, the City's Transit-First Policy, best practices in environmental planning and pedestrian-oriented, multi-modal street design, and incorporation of sustainable water management techniques to ensure continued quality of life, economic well-being, and environmental health in San Francisco.
- (b) In furtherance of the Better Streets Policy, the City recognizes that San Francisco's streets constitute a large portion of the City's public space. Implementation of the Better Streets Policy will ensure that such streets will continue to be:
  - (1) Corridors for all modes of transportation, with a particular emphasis on pedestrians and transit priorities;
  - (2) Organizers of the City's development pattern and how individuals perceive such a pattern; and
  - (3) An integral component of San Francisco's water management infrastructure.

- (c) The Better Streets Policy also is intended to ensure that the City's public rights-of-way become:
  - (1) Attractive, safe, and useable public open spaces corridors with generous landscaping, lighting, and greenery;
  - (2) Sustainable and healthy components of the City's ecology, taking advantage of available technologies to reduce the environmental impact of our street systems and to comprehensively manage storm-water based on established principles of watershed planning;
  - (3) Providers of access to properties, public view corridors, light, and air; and
  - (4) Providers of habitat for urban wildlife.
- (d) As part of an approval or decision concerning any public and private project that impacts or is adjacent to a publicly-accessible right-of-way, all City departments shall coordinate their various determinations regarding the planning, design, and use of public rights-of-way in accordance with the Better Streets Policy and the following supporting principles:
  - (1) Streets must be designed as a whole, cognizant of the facing buildings and uses within them, such that the resulting street environment is of appropriate scale and character.
  - (2) Streets that support and invite multiple uses, including safe, active, and ample space for pedestrians, bicycles, and public transit, are more conducive to the public life of an urban neighborhood and efficient movement of people and goods than streets designed primarily to move automobiles. Decisions regarding the design and use of the City's limited public street space shall prioritize space for pedestrians, bicycles, and public transit over space for automobiles.



- (3) Streets should be appropriately designed and maintained to ameliorate negative effects of traffic on pedestrian areas and adjacent uses, to provide usable on-street open spaces, to enhance property values, and to increase the safety and attractiveness of neighborhoods.
- (4) Streets should be appropriately designed and maintained to address the unique characteristics and challenges of the watersheds in which they lie through design treatments that reduce downstream flooding with untreated stormwater and combined sewer overflows into the San Francisco Bay and Pacific Ocean. Decisions regarding City street design and use shall include techniques that reduce impacts on the combined sewage and stormwater system and increase permeable surface area through the planting of street trees and landscaping and minimization of unnecessary pavement. Designs also shall incorporate strategies that facilitate the health and maintenance of street trees and landscaping, such as use of drought-tolerant plantings, passive rainwater retention systems, piping for recycled water, and other water management technologies that minimize the need for potable irrigation water.
- (5) The design of the City's streets shall minimize visual clutter. This concern shall extend to the number, design, and placement of signs, signals, utility structures, and elements oriented to vehicular traffic. Decisions regarding signs and signals for the control of vehicles must consider and balance the visual impact of the design of the street on all users and the image of the City.
- (6) The control and signalization of vehicular traffic has significant impacts on the quality and safety of the street experience for all users, including pedestrians, bicyclists, and public transit users and operators. Decisions regarding the systems and signals for the control of vehicles, including, but not limited to, changes to signal timing, speed limits, and allowable turning movements, must consider and balance the impact on the street experience and safety of all users.
- (7) The design of the right-of-way and adjacent development, including the maintenance and removal of street trees and other landscaping, allowance of curb cuts, and placement of utilities, have significant impact on the street environment. Decisions regarding street design must consider and prioritize pedestrian safety, enjoyment, and comfort.
- (8) Paved space on many of the City's streets is more than is needed for the safe and efficient movement of transit, bicycles, and automobiles. The City will encourage innovative solutions to reuse such excess street space as planted or open space areas. The City also will consider establishing a program to encourage and make it possible for adjacent neighborhoods to replace paved areas with usable open space, permeable surfaces, plantings, stormwater retention areas, and other public amenities.
- (9) New technologies and the rethinking of old techniques will provide opportunities for more sustainable design of our public rights-of-way to increase opportunities for public use and enjoyment, reduce pollution and water usage, better manage stormwater, and provide the opportunity for environmental education where possible. The City will encourage and facilitate the use of innovative solutions based on best practices in environmental planning and pedestrian-oriented, multi-modal design for its publicly-accessible rights-of-way.
- (10) Major new developments, both public and private, often include the rebuilding of portions of public rights-of-way and should serve as models of the Better Streets Policy. Special efforts should be made to ensure that such new developments lead by example. Public projects should establish model street and open space designs and private projects should incorporate stronger street design and landscaping standards. The City should encourage local residents, businesses, and other stakeholders to collaboratively develop such designs and standards in order to foster the community's active use and sense of ownership of these spaces over time.

*( Ord. 33-06, File No. 051715, App. 3/10/2006 )*

# B. Transit-First Policy

## SAN FRANCISCO CITY CHARTER

### SECTION 8A.115. TRANSIT-FIRST POLICY.

- (a) The following principles shall constitute the City and County's transit-first policy and shall be incorporated into the General Plan of the City and County. All officers, boards, commissions, and departments shall implement these principles in conducting the City and County's affairs:
1. To ensure quality of life and economic health in San Francisco, the primary objective of the transportation system must be the safe and efficient movement of people and goods.
  2. Public transit, including taxis and vanpools, is an economically and environmentally sound alternative to transportation by individual automobiles. Within San Francisco, travel by public transit, by bicycle and on foot must be an attractive alternative to travel by private automobile.
  3. Decisions regarding the use of limited public street and sidewalk space shall encourage the use of public rights of way by pedestrians, bicyclists, and public transit, and shall strive to reduce traffic and improve public health and safety.
  4. Transit priority improvements, such as designated transit lanes and streets and improved signalization, shall be made to expedite the movement of public transit vehicles (including taxis and vanpools) and to improve pedestrian safety.
  5. Pedestrian areas shall be enhanced wherever possible to improve the safety and comfort of pedestrians and to encourage travel by foot.
  6. Bicycling shall be promoted by encouraging safe streets for riding, convenient access to transit, bicycle lanes, and secure bicycle parking.
  7. Parking policies for areas well served by public transit shall be designed to encourage travel by public transit and alternative transportation.
  8. New transportation investment should be allocated to meet the demand for public transit generated by new public and private commercial and residential developments.
  9. The ability of the City and County to reduce traffic congestion depends on the adequacy of regional public transportation. The City and County shall promote the use of regional mass transit and the continued development of an integrated, reliable, regional public transportation system.
  10. The City and County shall encourage innovative solutions to meet public transportation needs wherever possible and where the provision of such service will not adversely affect the service provided by the Municipal Railway.
- (b) The City may not require or permit off-street parking spaces for any privately-owned structure or use in excess of the number that City law would have allowed for the structure or use on July 1, 2007 unless the additional spaces are approved by a four-fifths vote of the Board of Supervisors. The Board of Supervisors may reduce the maximum parking required or permitted by this section.

*( Amended by Proposition A, Approved 11/6/2007 )*

Note: Formerly § 16.102.



# C. “Complete Streets” Policy

## SAN FRANCISCO PUBLIC WORKS CODE

### SECTION 2.4.13. TRANSIT, PEDESTRIAN, AND BICYCLE IMPROVEMENTS AS PART OF PLANNING, CONSTRUCTION, RECONSTRUCTION, AND REPAVING PROJECTS

- (a) Whenever the Department or other Municipal Excavator undertakes a project involving the planning, construction, reconstruction, or repaving of a public right-of-way, such project shall include, to the maximum extent practicable and feasible, the following transit, pedestrian, and bicycle improvements:
  - (1) Street and pedestrian-scale sidewalk lighting;
  - (2) Pedestrian and bicycle safety improvement measures, as established in any official City adopted bicycle or pedestrian safety plan or other City adopted planning documents;
  - (3) Appropriate access in accordance with the Americans with Disabilities Act;
  - (4) Public transit facilities accommodation, including, but not limited to designation of the right-of-way as a transit preferential street designation or bus rapid transit corridor;
  - (5) Traffic calming devices;
  - (6) Landscaping;
  - (7) Streetscape amenities; and
  - (8) Other street and sidewalk improvements consistent with the City’s “Transit-First Policy.”
- (b) The Director, in consultation with the Executive Director of the Municipal Transportation Agency, Department of Public Health, and other affected City departments, including the Planning Department and Department on the Environment, shall develop orders, regulations, or amendments to the Department’s Standard Plans and Specifications that address the improvements set forth in Subsection (a).
- (c) To the maximum extent practicable and feasible, the Director shall condition all excavation and street improvement permits on the inclusion of the improvements set forth in Subsection (a). If such conditions would exceed the Director’s regulatory authority, the Director shall coordinate with other City departments to provide, to the maximum extent practicable and feasible, said improvements on behalf of the City. As part of the decision on any permit or authorization pursuant to the Public Works Code, the Director shall take into account the permit activity’s positive and negative impacts on the integration, enhancement, or preservation of the improvements set forth in Subsection (a).

*(Added by Ord. 209-05, File No. 050591, App. 8/18/2005)*

## D. Summary of Community Involvement

The Better Streets city team has held 5 rounds of public outreach on the Better Streets Plan, with over 100 Better Streets outreach events and thousands of attendees in total, including public meetings, presentations to community groups, focus group interviews, tabling events, and walking tours. Community meetings have been held in many different neighborhoods throughout the city.

### ROUND 1 MEETINGS: APRIL-JUNE 2007

During the first round of public outreach for the Better Streets Plan, the City held over 35 public meetings to gather public input, including:

- a citywide kick-off event held at City Hall on April 5, 2007;
- 4 neighborhood meetings in different neighborhoods around the City;
- 3 meetings targeted for populations specifically affected by the pedestrian environment, such as seniors and people with mobility or visual impairments;
- 4 focus groups in neighborhoods to get directed community input; and
- over 25 meetings with neighborhood and advocacy organizations, held by request of the organization.

The first round of outreach provided residents the opportunity to comment on the vision and goals of the Better Streets Plan and to provide input into the issues of greatest concern in their neighborhood. At each meeting, there were multiple ways for the public to give its input into the Better Streets Plan goals and objectives, including:

- facilitated small group exercises;
- comment boards;
- question and answer periods for City staff from multiple departments;
- surveys;
- comment sheets; and
- informal discussion and correspondence.

### Survey Results

Nearly 1,000 people from across the city filled out the Round 1 Better Streets Plan survey, both in print and online. The surveys asked respondents to rank on a scale of 1 to 7 the most important street improvements to them.

The five most highly rated improvements in order of priority were:

- street trees;
- greenery (landscaping other than trees);
- sidewalk maintenance;
- clear sidewalks (free from obstructions); and
- slower traffic.





**TABLE A.1.** AVERAGE SCORE FOR STREET IMPROVEMENTS  
(SCALE OF 1 TO 7)

Trees	5.6
Greenery	5.4
Sidewalk Maintenance	5.3
Blocked Sidewalks	5.3
Slower Traffic	5.3
Pedestrian Lighting	5.1
Places to Sit	5.0
Crosswalk Conditions	5.0
Sidewalk Materials	4.8
Countdown Signals	4.8
Wider Sidewalks	4.6
Narrow Street Crossings	4.1
Curb Ramps	4.0

The survey also asked respondents to describe how frequently they walk in the city to various destinations. The results are summarized in Table 2.

**TABLE A.2.** FREQUENCY OF WALKING TRIPS FROM HOME

	AT LEAST SEVERAL TIMES PER WEEK	ONCE PER WEEK OR LESS
Transit	64%	36%
Café or Restaurant	61%	39%
Buy Groceries	54%	46%
Visit a Friend	39%	61%

## Key Issues

### *Aesthetics and landscaping*

Community participants in Round 1 indicated that they value aesthetics and greening of the City's streets and sidewalks. Participants felt that San Francisco could do more to improve the attractiveness of its pedestrian spaces by paying more attention to the design of landscaping, lighting, choice of materials, and street furnishings. Participants also emphasized the importance of keeping streets and sidewalks clean and in good repair.

### *Community space*

Community participants also expressed a desire to see more and better spaces for community interaction. Participants felt that there are too many cars, moving too fast, and not enough safe and attractive spaces for pedestrians. Overall, participants' comments either were directed at creating better conditions for pedestrians, mostly by mitigating the negative effect of traffic, or at creating new or better spaces for pedestrians, such as by creating new public plazas that have pedestrian amenities.

### *Ecological design*

Participants were also interested in ecological design of streets, despite often not being familiar with the technical details. Tree planting and green landscaping were viewed as two of the most important elements in building more enjoyable and more attractive sidewalks and streets. Participants also expressed interest in ecological design for stormwater management.

### *Pedestrian Safety*

Many community participants highlighted pedestrian safety as a primary concern. Participants frequently mentioned calming auto traffic and increasing pedestrian visibility as two means to achieve a higher level of pedestrian safety. Participants also frequently mentioned better enforcement of existing laws, such as the prohibition of parking on the sidewalk, as a key priority.

### *Universal Access*

Lastly, participants highlighted a need for street design to be accessible for all. Universal access focused on removing barriers to moving about, such as narrow, broken and/or cluttered sidewalks, cars parked on the sidewalk, and inadequate lighting for pedestrians. Many participants also highlighted that transit service and bicycling are intimately linked to the quality of the pedestrian environment, and mentioned the need for better conditions around transit stops and bikeways.

## ROUND 2 MEETINGS: JULY-SEPTEMBER 2007

Round 2 meetings consisted of a number of different types of community involvement spread across town, including:

- 4 tabling events at key pedestrian locations;
- 2 key user group meetings;
- 6 focus groups (stakeholder interviews with key organizations);
- over 25 neighborhood meetings attended;
- a walking tour; and
- a Round 2 survey.

### *Tabling events*

Four tabling events were held, at Ferry Plaza (Embarcadero), at Vallejo and Grant Streets (outside Cafe Trieste, North Beach), at the West Portal Muni Station, and at the 24th Street/Mission BART station. Tabling events were designed to reach members of the public who might not generally come to a formal public meeting. At all tabling events, City staff was present to hand out information on the Better Streets Plan, distribute surveys, and discuss plan concepts with members of the public.

### Stakeholder interviews

Stakeholder interviews were held with directors of the following organizations: Chamber of Commerce, Convention and Visitors Bureau, Friends of the Urban Forest, Livable City, San Francisco Bike Coalition, Senior Action Network, SF Beautiful, Small Business Network, SPUR, Urban Land Institute, WalkSF, and Youth Leadership Institute. Meetings were held with two groups at a time, to encourage people to look beyond their organizations' particular mission.

The Better Streets Team also held two meetings with key user groups who are disproportionately impacted by pedestrian conditions, including seniors and people with disabilities. Meetings were held with Senior Action Network, Lighthouse for the Blind and Visually Impaired, and the Independent Living Resource Center. The latter two decided to combine into one meeting.

At each meeting, a brief presentation was followed by interactive small group exercises to discuss participants' priorities about streetscape and pedestrian design, and to get their feedback on initial plan concepts.

### Neighborhood Meetings

Round 2 also included several presentations to community groups, including Network for Elders, North Beach Neighbors, Quesada Gardens Initiative, and Taraval Merchants Association.

### Youth Walking Tour

Finally, the Better Streets Team conducted a walking tour with BAYCAT, Literacy for Environmental Justice, and Youth Leadership Institute. The walking tour took 10 high school and college-aged youth from the Bayview neighborhood on a tour of local streets. BAYCAT, a Bayview arts education organization, filmed the entire walking tour and prepared a video of the event, available at [www.sfbetterstreets.org](http://www.sfbetterstreets.org).

Much of the tour was centered on the Third Street corridor, with the plaza at Third and Palou as the culminating point. Individual participants pointed out various notable streetscape elements. Participants also noted specific streetscape problems, the human consequences of those problems, and possible solutions through physical design. After the tour, participants gathered to discuss the tour and provide input to the Better Streets Plan.

### ROUND 3 MEETINGS: JUNE 2008

Round 3 of Better Streets Plan outreach coincided with the release of the Better Streets Plan Draft for Public Review. On June 5, 2008, Mayor Gavin Newsom officially released the Draft Better Streets Plan at a press event at the newly renovated Mint Plaza public space, with approximately 50 members of the public, press officials, City officials, and City staff in attendance. Following the presentation, City staff were on hand to answer questions and receive comment from the public.

The plan release event was followed by a series of four community meetings and one walking tour, co-hosted by neighborhood groups engaged in streetscape improvement efforts, with over 100 people attending in total. City staff presented an overview of the Draft Plan, and responded to public questions and comments. City staff also met with key stakeholder organizations to receive targeted input into the Draft Better Streets Plan.

At that time, the Better Streets Team also solicited written comment on the Draft Plan, receiving over 100 comments from a variety of individuals and organizations. Written comment on the Draft Plan was summarized and made available at [www.sfbetterstreets.org](http://www.sfbetterstreets.org). The Better Streets Team made revisions to the Draft Plan based on the public comment heard at Round 3 meetings and written comments received subsequently.

### ROUND 4 MEETINGS: OCTOBER-DECEMBER 2009

The Better Streets Team held a number of public discussions and informational hearings beginning in October 2009 to present Plan Revisions based on public comment on the Draft Plan.

Public informational presentations were held at the Board of Supervisors Land Use and Economic Development Committee, the Mayor's Disability Council, the Pedestrian Safety Advisory Committee, the Planning Commission, and the Wastewater Citizen's Advisory Committee. Public discussions were held at SPUR and the Treehouse Talk series. All meetings were open to the general public.

The list on the following page summarizes community meetings attended by Better Streets Plan staff to present and gather feedback on the plan development. The list does not include monthly Community Advisory Committee meetings.

### ROUND 5 MEETINGS: JUL-DECEMBER 2010

Mayor Gavin Newsom officially announced the release of the Better Streets Plan Final Draft in conjunction with the ribbon-cutting for streetscape improvements on Valencia Street at a well-attended press event on July 15, 2010. In September 2010, the Mayor introduced legislation that would amend the San Francisco General Plan and Municipal Codes related to the Better Streets Plan.

Following the introduction of the proposed legislation, the City held a series of public hearings at the Planning Commission and Board of Supervisors to adopt the Plan and the proposed legislation. The Plan and legislation were officially adopted by the Board of Supervisors on December 7, 2010.



## LIST OF COMMUNITY MEETINGS AND OUTREACH EVENTS

#	EVENT / ORGANIZATION	DATE	ROUND OF OUTREACH
01	SPUR lunchtime forum on Better Streets Plan		
02	SPUR Sustainability Committee: Integrated Stormwater Management Design Charette	10/25/2006	
04	Shape Up Coalition	11/28/2006	
05	Haight Ashbury Neighborhood Council	1/8/2007	
06	Shape Up Coalition: Walking Challenge closing ceremony	1/8/2007	
07	Bayview Hunters Point Pedestrian Safety Planning Project: Community Forum	1/25/2007	
08	DPW Tree Planting Forum	3/10/2007	
09	Potrero Hill Traffic Calming Meeting	3/22/2007	
10	Balboa Ave. Streetscape Design Community Meeting	3/29/2007	
11	Better Streets Kick-Off Meeting at City Hall	4/5/2007	1
12	SPUR Urban Planning, Transportation, and Sustainability Committees	4/13/2007	1
13	Better Streets Neighborhood Meeting-West Portal	4/16/2007	1
14	Better Streets Neighborhood Meeting-Richmond	4/18/2007	1
15	Better Streets Neighborhood Meeting-Eureka Valley	4/19/2007	1
16	Better Streets Neighborhood Meeting-SoMa	4/24/2007	1
17	Kaiser-Richmond Health Fair	4/28/2007	1
18	Tenants Action Coalition: Housing Committee	5/2/2007	1
19	Golden Gate Heights Neighborhood Association	5/3/2007	1
20	SF Beautiful: Public Affairs Committee	5/4/2007	1
21	EnCore	5/7/2007	1
22	WalkSF	5/7/2007	1
23	Alliance for a Better District 6	5/8/2007	1
24	Friends of Noe Valley	5/10/2007	1
25	Senior Action Network	5/10/2007	1
26	Project Artaud	5/14/2007	1
27	Bayview Focus Group	5/17/2007	1
28	North of Panhandle Neighborhood Association	5/17/2007	1
29	Chinatown CDC	5/18/2007	1
30	Divisadero Merchants	5/21/2007	1

#	EVENT / ORGANIZATION	DATE	ROUND OF OUTREACH
31	Wastewater CAC		1
32	FixMasonic	5/31/2007	1
33	Visitacion Valley Planning Alliance	6/9/2007	1
34	Lighthouse for the Blind	6/16/2007	1
35	Friends of the Urban Forest	6/18/2007	1
36	Independent Living Resource Center	6/19/2007	1
37	Neighborhood Marketplace Initiative	6/20/2007	1
38	Clementina Cares	6/20/2007	1
39	Quesada Gardens	6/27/2007	1
40	Mayor's Town Hall Meeting on Transportation-District 3	6/30/2007	1
41	Duboce Triangle Neighborhood Association	7/9/2007	1
42	All Communities Partnership	7/17/2007	2
43	Stakeholder Interview: Friends of the Urban Forest /SF Bicycle Coalition	7/20/2007	2
44	Stakeholder Interview: Livable City/Chamber of Commerce	7/24/2007	2
45	Stakeholder Interview: Convention and Visitors Bureau/WalkSF	7/25/2007	2
46	Community Benefits Districts	7/25/2007	2
47	ADA Celebration	7/26/2007	2
48	Stakeholder Interview: Youth Leadership Institute/SPUR	7/26/2007	2
49	Stakeholder Interview: Small Business Network/Senior Action Network	7/27/2007	2
50	Stakeholder Interview: Urban Land Institute/SF Beautiful	7/30/2007	2
51	Community Leadership Alliance	7/31/2007	2
52	Planning Association of the Richmond	8/6/2007	2
53	Network for Elders	8/14/2007	2
54	Tabling: Vallejo and Grant, North Beach	8/16/2007	2
55	Tabling: Embarcadero Farmer's Market	8/18/2007	2
56	Tabling: 3rd Street Muni Station-Bayview Town Center	8/18/2007	2
57	Tabling: 24th Street BART Station	8/21/2007	2
58	Tabling: West Portal Muni Station	8/22/2007	2
59	Fillmore Jazz CBD	8/22/2007	2

#	EVENT / ORGANIZATION	DATE	ROUND OF OUTREACH
60	Independent Living Resource Center/Lighthouse for the Blind and Visually Impaired	8/22/2007	2
61	Taraval Merchant's Association-District 4	9/6/2007	2
62	North Beach Neighbors	9/10/2007	2
63	ReBar/Public Architecture--Park(ing) Day Planning Meeting	9/11/2007	2
64	Quesada Gardens-District 10	9/12/2007	2
65	Senior Action Network	9/13/2007	2
66	Walking Tour: Youth Leadership Institute/Literacy for Environmental Justice	9/15/2007	2
67	Chamber of Commerce	10/9/2007	2
68	SF Tomorrow	10/10/2007	2
69	Transit Effectiveness Project CAC	10/11/2007	2
70	California Urban Forest Conference	11/2/2007	2
71	Mayor's Council on Disability	11/16/2007	2
72	Urban Forest Council	12/14/2007	2
73	SPUR Sustainability Committee	4/10/2008	2
74	Better Streets Draft Plan unveiling	6/5/2008	3
75	Round 3 Stakeholder Roundtable	6/9/2008	3
76	Round 3 Stakeholder Roundtable	6/10/2008	3
77	Better Streets walking tour and Neighborhood Meeting-hosted by WalkSF/Encore	6/7/2008	3
78	Better Streets Neighborhood Meeting-hosted by FixMasonic	6/11/2008	3
79	Better Streets Neighborhood Meeting-hosted by Senior Action Network	6/12/2008	3
80	Better Streets Neighborhood Meeting-hosted by C.C. Puede/ San Jose Guerrero Coalition to Save Our Streets/Precita Valley Neighbors	6/12/2008	3
81	WalkSF Annual Meeting	6/18/2008	3
82	SPUR lunchtime forum "The Making of the Better Streets Plan"	6/26/2008	3
83	SFMTA Board meeting	7/1/2008	3
84	Bi-County Study outreach event	11/5/2008	3
85	Bi-County Study outreach event	12/10/2008	3
86	Physical Access Committee of Mayor's Disability Council	3/18/2009	3

#	EVENT / ORGANIZATION	DATE	ROUND OF OUTREACH
87	SPUR Transportation Committee	4/6/2009	3
88	California Council for the Blind	5/16/2009	3
89	District 1 Town Hall Meeting	5/30/2009	3
90	District 1 follow up meeting	7/8/2009	3
91	Sunday Streets - Mission District	7/19/2009	3
92	Physical Access Committee of Mayor's Disability Council	10/9/2009	4
93	Wastewater Citizen's Advisory Committee	10/15/2009	4
94	Treehouse Talk (SFBC, etc.)	10/20/2009	4
95	Planning Commission	10/22/2009	4
96	Board of Supervisors Land Use Committee	11/2/2009	4
97	Pedestrian Safety Advisory Committee	11/10/2009	4
98	Mayor's Council on Disability	11/16/2009	4
99	SPUR Transportation Committee	12/7/2009	4
100	Final Draft Plan Release - Valencia Street ribbon-cutting	7/15/2010	5
101	Planning Commission - Initiation hearing	10/7/2010	5
102	Planning Commission - Adoption hearing	10/28/2010	5
103	North Beach Neighbors	11/8/2010	5
104	Land Use and Economic Development Committee	11/15/2010	5
105	Board of Supervisors - First Reading	11/22/2010	5
106	Board of Supervisors - Second Reading	12/7/2010	5



# E. Summary of Accessibility Guidelines

The following list summarizes key accessibility guidelines for the public right-of-way.

## General Notes

1. California Civil and Government Code provides basic requirements for accessibility in the public right-of-way built by state and local governmental entities, which includes compliance to the minimum standards of California Building Code (CBC) and US Access Board's Accessibility Guidelines for the Americans with Disabilities Act (ADAAG).
2. The San Francisco Public Works Code provides requirements for sidewalks, curb ramps, sidewalk café tables and chairs, and merchandise and produce display encroachments on sidewalks.
3. The San Francisco Planning Code (PC) provides other requirements for public space and design guidelines for specific special use districts.
4. US Access Board's Americans with Disabilities Act and Architectural Barriers Act (ADA/ABA) and US Access Board's Draft Guidelines for Accessible Public Rights-of-Way (PROWAG) provide other best practices for alternate pedestrian routes, accessible pedestrian signals, street furniture, signage, call boxes, escalators, elevator doors, doorways, and gates.
5. Each of the requirements or best practices listed in this appendix may have other technical requirements. See the referenced source for this information.

## Index to requirements or guidelines

- Scoping (when or where required, if provided and/or minimum quantity)
- Dimensions
- Requirement or recommended best practices, Source

## Requirements and Guidelines

### Width of accessible route for pedestrians

- Pedestrian access routes shall connect to elements required to be accessible, and where provided for the general public
- 36" min. width
- Requirement, ADAAG

### Minimum accessible route for passage of two wheelchairs

- One per 200'
- 60 x 60" min.
- Requirement, ADAAG

### Height of accessible route

- Where provided
- 80" min.
- Requirement, ADAAG and CBC
- Under awnings
- 96" minimum and other dimension criteria of depth and running length
- Requirement, PC

### Sidewalk width

- Where provided for the general public
- 48" min.
- Requirement, CBC
- At sidewalk tables and chairs and sidewalk display merchandise
- 72" min.
- Requirement for sidewalk encroachment permits

### Clearance at planters adjacent to parallel parking

- Where provided
- 24" clear width; 4' pass-throughs at each parking space aligned with mid-point of parking space
- Best practice



## PRINCIPLES OF UNIVERSAL DESIGN

The Better Streets Plan seeks to encourage livable street design where pedestrian amenities, street greening, vehicular and bicycle transportation, traffic calming, stormwater management, and accessibility are seamlessly integrated with one another. Universal Design is a best practice that seeks to serve the needs of individuals with disabilities while providing cross-benefit to everybody.

There are seven core principles in this paradigm, although not each may have application to a particular design issue.

1. **Equitable Use** - The design is useful and marketable to people with diverse abilities.
2. **Flexibility in Use** - The design accommodates a wide range of individual preferences and abilities.
3. **Simple and intuitive** - Use of the design is easy to understand, regardless of the user's experience, knowledge, language skills, or current concentration level.
4. **Perceptible Information** - The design communicates necessary information effectively to the user, regardless of ambient conditions or the user's sensory abilities.
5. **Tolerance for Error** - The design minimizes hazards and the adverse consequences of accidental or unintended actions.
6. **Low Physical Effort** - The design can be used efficiently and comfortably and with a minimum of fatigue.
7. **Size and Space for Approach and Use** - Appropriate size and space provided for approach, reach, manipulation, and use regardless of user's body size, posture, or mobility.

More information on Universal design can be found at The Center for Universal Design's web site <http://www.design.ncsu.edu/cud/>

### Accessible ground surface

- Where provided
- 1/4" max. for vertical changes in level
- 1/4-1/2" beveled no greater than 1:2 ratio
- More significant grade changes conducted with sloped surface less than 1:20 slope, or ramp of 1:20 to 1:12 slope
- 2% cross-slope
- *Requirement, CBC/ADAAG*

### Grates and drains

- Where provided
- 1/2" max. wide openings in one direction
- Elongated openings placed perpendicular to direction of travel
- *Requirement: CBC/ADAAG*

### Forward reach ranges to pedestrian operated controls

- Where provided
- 15 to 48" at front of wheelchair space
- *Requirement ADAAG & CBC*

### Side reach ranges to pedestrian operated controls

- Where provided
- 9 to 54"
- Requirement, ADAAG & CBC
- 9 to 48"
- *Best Practice, ADA/ABA*

### Wheelchair level, clear floor area at pedestrian controls

- At pedestrian controls
- 30 x 48", additional 6" width or 12" depth in alcove or constrained conditions
- *Requirement, ADAAG & CBC*

### Stairs

- Where provided for the general public
- Handrails on both sides with extensions
- Level top and bottom landings
- 2" contrasting striping on stair nosings
- 48" min. width
- *Best practice, none*

### Curb ramps

- At pedestrian crossings of street and roads with curbs
- 48" min. width
- *Requirement, DPW standards prevail over ADAAG or CBC*

### Ramps

- 48" min. width
- Sloped surface 1:20 to 1:12; cross-slope max. 2%
- Landings each 30" of rise
- Landings min. width of ramp and 60" in running, except bottom landing 72" min. length and 60" x 60" at mid landings where change of direction exceeds 30 degrees
- Handrails on both sides with handrail extensions where ramp exceeds 6" vertical rise or 72" length
- Wheel guards at base of sides of ramp
- *Requirement; CBC/ADAAG*

### Medians and Pedestrian Refuge Islands

- Where provided at streets or roads with cross walks through medians
- 48" min. width, 72" min. length in the direction of pedestrian travel
- *Best practice, ADA/ABA*

### Detectable warnings at curb ramps

- Where provided
- Full depth and width of the curb ramp
- Requirement, ADAAG and CBC
- 36" min. in direction of travel and full width of ramped surface
- *Currently Accepted Best practice, California State Architect IR 11B-3*

### Detectable warnings at hazardous vehicular areas

- Where a walk crosses or adjoins a vehicular way
- Continuous width, 36" minimum depth in direction of travel
- *Requirement, CBC*

### Detectable warnings at transit boarding platforms

- Where provided
- 24" minimum depth and other requirements within CBC
- *Requirement, CBC*

### Detectable warning products

- Where provided
- *Requirement, only approved DSA/AC and DPW detectable warning products*

### Detectable surfaces

- Where provided
- Textured surface material in contrast to sanded, broom or other similar smooth surface, which may be caning detectable but no more than 1/2" high
- *Best Practice*

### Color contrast and shade

- Dark on light or light on dark; 70% color or shade gradient preferred
- *Best practice*

### Bus stop boarding and alighting areas

- Where provided
- 96" min., measured perpendicular to the curb or vehicle roadway edge; a clear width of 60" min., measured parallel to the vehicle roadway
- *Requirement, CBC*

### Bus shelters

- Where provided
- Contain a wheelchair clear floor space within the cover of the shelter and an accessible route to the bus stop boarding and alighting area
- *Best practice, PROWAG*

### Wheelchair space at benches

- Where provided
- Wheelchair clear floor area with shoulder alignment point of the wheelchair space at 36" to bench or seat
- *Best practice, ADA/ABA*



## F. Glossary

### *Accessible pedestrian signal*

Pedestrian signal located at a crosswalk that provides crossing information in a non-visual format such as audible tones, verbal messages and/or vibrating surfaces

### *Advance stop and yield lines*

A stop line is a required solid white line, 12 to 24 inches wide, extending across all vehicle approach lanes to indicate where vehicles must stop in compliance with a stop sign or signal. A yield line is an optional row of white triangles placed across approach lanes to indicate the point at which vehicles must yield at locations without a signal or stop sign.

### *Best Management Practice (BMP)*

Operating methods and/or structural devices used to reduce stormwater volume, peak flows, and/or pollutant concentrations of stormwater runoff through one or more of the following processes: evapotranspiration, infiltration, detention, filtration and biological and chemical treatment

### *Bioinfiltration*

A process that uses vegetation to capture and biologically degrade pollutants. Water is biologically treated while percolating through the system and into the existing soils, providing groundwater recharge.

### *Bioretention*

A soil and plant-based retention practice that captures and biologically degrades pollutants as water infiltrates through subsurface layers containing microbes that treat pollutants. Treated runoff is then slowly infiltrated and recharges the groundwater.

### *Blended Transition*

A connection with a grade of 5 percent or less between the level of the pedestrian walkway and the level of the crosswalk<sup>1</sup>

### *Bollard*

Short post or vertical element designed to separate or buffer pedestrians from vehicle areas

### *Bulb-out*

See curb extension

### *Bus bulb*

Curb extension housing a transit stop to allow transit vehicles to board without pulling in and out of traffic

### *Chicane*

A traffic calming measure that slows traffic by visually narrowing the roadway and causing vehicles to laterally shift from side to side

### *Continental crosswalk*

High visibility crosswalk marking that features 2-foot wide crosswalk stripes, parallel to the curb and the full width of the crosswalk, separated by 2-foot spaces between stripes. Not to be confused with a ladder crosswalk, which uses a similar striping pattern but also retains the transverse stripes of a standard crosswalk at both edges.

### *Conveyance*

The process of water moving from one place to another

### *Corner Island*

Roughly triangular striped area or raised island between through traffic lanes and a right-turn slip lane. Often referred to as a “pork chop” island.

### *Crosswalk*

Legally designated location for pedestrians to cross from one side of a roadway to the other. Present at all intersections that intersect at approximately right angles; may be marked or unmarked.

### *Curb cut*

Location where the sidewalk curb is depressed to the level of the roadway, either for a curb ramp, driveway, or other feature

### *Curb extension*

Location where the sidewalk edge is extended from the prevailing curb line into the roadway at sidewalk grade, effectively increasing pedestrian space. Also called a bulb-out.

### *Curb radius*

Radius defining the sharpness of the curve that the curb or edge of the sidewalk follows as it turns a corner

### *Curb ramp*

Location where the curb is depressed to the level of the roadway to provide a flush transition from the sidewalk to the roadway to enable accessible street crossing or movement

### *Decomposed granite*

A common surfacing material for tree basins, planters, and informal pathways

### *Design storm (Minor storm)*

A rainfall event of specified intensity and frequency that is used to calculate the runoff volume and peak discharge rate for the design of stormwater treatment facilities.

### *Design vehicle*

Type of vehicle used to determine appropriate roadway design characteristics such as curb radius

### *Detectable warning*

A surface feature of truncated dome material built in or applied to the walking surface to advise of an upcoming change from pedestrian to hazardous vehicular way<sup>2</sup>

<sup>1</sup> Draft Federal Accessibility Guidelines for Public Rights-of-Way

<sup>2</sup> Ibid

***Detention***

Stormwater runoff that is collected at one rate and then released at a lower rate. The difference is held in temporary storage.

***Driveway***

Location where the sidewalk curb is depressed to the level of the roadway, in order to provide vehicle access across the sidewalk to parcels

***Edge zone***

Portion of the sidewalk between the curb and the furnishings zone, used for getting in and out of parked vehicles

***Extended bulb-out***

Curb extension that continues significantly beyond the typical corner area, to allow space for landscaping or public use

***Extension zone***

Area where the pedestrian realm may be extended into the roadway, either permanently (e.g. with curb extensions) or temporarily (e.g. with temporary café seating)

***Filtration***

A treatment process that allows for removal of solid (particulate) matter from water by means of porous media such as sand, soil, or a man-made filter. Filtration is used to remove contaminants.

***Flashing beacon***

Flashing light amber colored light mounted to a pole adjacent to or above the roadway to alert drivers to an upcoming pedestrian crosswalk

***Flexible parking zone***

Parking lane that is used temporarily or semi-permanently for other uses, such as café or public seating

***Frontage zone***

Portion of the sidewalk adjacent to the property line edge, which may be used for merchandise displays, outdoor seating, or the like

***Furnishings zone***

Portion of the sidewalk between the edge zone and the throughway zone that contains the majority of street trees, plantings, lighting, and site furnishings

***High-visibility crosswalk***

Marked crosswalks that use longitudinal or diagonal stripes to increase crosswalk visibility to approaching vehicles

***Island***

An area between traffic lanes used for control of traffic movements; differentiated from medians by being generally not linear or continuous throughout the block

***Infiltration***

The process by which water penetrates into soil from the ground surface

***In-roadway flashing lights***

A series of flashing lights embedded in the roadway on either side of a crosswalk and facing approaching vehicles that alert approaching drivers to an upcoming crosswalk

***Low Impact Design (LID)***

An innovative stormwater management approach with a basic principle that is modeled after nature: manage rainfall at the source using decentralized micro-scale facilities

***Major storm event***

A rainfall event that is larger than the design storm.

***Marked crosswalk***

White or yellow retro-reflective thermoplastic striping in the roadway to delineate the presence of a crosswalk

***Median***

The portion of the roadway separating opposing directions of the traveled way, or local lanes from through travel lanes. Medians are generally linear and continuous through a block, and may be depressed, raised, or flush with the road surface.

***Mid-block crosswalk***

Marked crosswalk at a mid-block (non-intersection) location

***Modern roundabout***

Yield-controlled circular intersection design used to control traffic on moderate to high volume streets.

***Multi-use path***

Pathway that may be used by a variety of non-motorized users, including walkers, runners, cyclists, and the like

***Multi-way boulevard***

Street type that separates through traffic from local access through the use of landscaped medians

***Peak flow***

The point during a rainstorm where there is the highest volume of runoff in the city's drainage system. Peak flow can be considered as the runoff 'peak' on a hydrograph.

***Pedestrian refuge***

Area protected by a raised median or island where people may safely pause or wait while crossing a street

***Pedestrian countdown signal***

Traffic signal located at crosswalks that, in addition to a standard pedestrian crossing signal, provides flashing numbers that count down the remaining seconds remaining before cross traffic is given a green light



***Pedestrian signal***

Traffic signal specifically aimed at directing pedestrian movement, such as ‘walk/don’t walk’ or the international pedestrian symbol signal (red hand, walking man)

***Permeability/Impermeability***

The quality of a soil or material that enables water or air to move through it, and thereby determines its suitability for infiltration-based stormwater strategies

***Pork chop***

See corner island

***Raised crosswalk or intersection***

Area where the level of the crosswalk or intersection is raised to the sidewalk grade to provide a continuous grade walking surface along the sidewalk

***Rain screen***

Planter along a building edge planted with vines that climb up the adjacent building

***Retention***

The reduction in total runoff that results when stormwater is diverted and allowed to infiltrate into the ground through existing or engineered soil systems

***Right-turn slip lane***

A vehicle lane that allows larger and faster vehicle turns by increasing the curb radius and adding a corner island or striped area between the right turn lane and adjacent through travel lanes; may be controlled or uncontrolled. A right-turn slip lane is considered a free right turn if vehicles enter into a dedicated travel lane upon exiting the slip lane.

***Runoff***

Water from rainfall that flows over the land surface that is not absorbed into the ground

***Sedimentation***

The deposition and/or settling of particles suspended in water as a result of the slowing of the water

***Shared public way***

Right-of-way that is designed at a single surface with no grade differentiation between street and sidewalk areas, and where roadway space is shared between pedestrians and slow-moving vehicles

***Shy zone***

Area of the sidewalk adjacent to buildings or other fixed objects where pedestrians instinctively maintain a certain distance from the object or building

***Site furnishings***

Facilities and amenities in the sidewalk to serve pedestrians, vehicles, and adjacent uses, that add design and functionality to the streetscape environment

***Standard crosswalk***

Basic marked crosswalk treatment that uses two parallel 12 inch crosswalk stripes, perpendicular to the curb, to delineate the two edges of the crosswalk

***Structural soil***

A designed medium consisting of soil, stone, aerated pockets, and other materials, intended to allow tree root growth without compromising pavement materials above the root area

***Throughway zone***

Portion of the sidewalk, generally located between the frontage zone and the furnishings zone, where pedestrians may move free of obstructions

***Thumbnail***

A small island forming the intersection side of a pedestrian refuge, often curved to roughly form the shape of a thumbnail

***Traffic calming***

Practice of designing streets to encourage drivers to proceed slowly through neighborhoods through the use of visual or actual roadway narrowings, horizontal or vertical shifts in the roadway, or other features

***Traffic calming circle***

Generally circular raised areas in the center of a standard intersection that provide space for landscaping, and slow traffic by visually shortening the roadway and forcing vehicles to slow to go around them

***Transit boarding island***

Raised area within the roadway that houses a transit stop, allowing transit vehicles to use center lanes without having to pull over to the side of the roadway for passengers to board

***Tree basin***

Open, unpaved area surrounding a street tree that allows space for tree root growth

***Tree grate***

Covering for a tree basin that creates a solid walking surface at sidewalk grade

***Tree guard***

Structure built around the trunk of a street tree to protect the tree during early growth

***Trench drain***

Channel covered with a metal grate used to convey water through sidewalk areas

***Understory landscaping***

Lower-level plantings located in sidewalk planters, such as grasses, shrubs, hedges, and the like

***Wayfinding signage***

Directional signage located on the sidewalk, used to help pedestrians orient themselves and locate nearby destinations

# G. Summary of Physical Elements in the BSP

## Standard Improvements

#	PHYSICAL ELEMENT	PLAN SECTION
01	Curb ramps	5.1
02	Marked crosswalks	5.1
04	Pedestrian-priority signal devices and timings	5.1
05	Curb radius guidelines	5.2
06	Corner curb extensions or bulb-outs	5.3
07	Street trees	6.1
08	Tree basin furnishings	6.1
09	Sidewalk planters	6.1
10	Stormwater management tools	6.2
11	Street and pedestrian lighting	6.3
12	Special paving	6.4
13	Site furnishings	6.5

## Case by Case Additions

#	PHYSICAL ELEMENT	PLAN SECTION
14	High-visibility crosswalks	5.1
15	Special crosswalk treatments	5.1
16	Restrictions on vehicle turning movements at crosswalks	5.1
17	Removal or reduction of permanent crosswalk closures	5.1
18	Mid-block crosswalks	5.1
19	Raised crosswalks	5.1
20	Extended bulb-outs	5.3
21	Mid-block bulb-outs	5.3
22	Center or side medians	5.4
23	Pedestrian refuge islands	5.4
24	Transit bulb-outs	5.5
25	Transit boarding islands	5.5
26	Flexible use of the parking lane	5.6
27	Parking lane planters	5.6
28	Chicanes	5.7
30	Traffic calming circles	5.7
31	Modern roundabouts	5.7
32	Sidewalk or median pocket parks	5.8
33	Reuse of 'pork chops' and excess right-of-way	5.8
34	Multi-way boulevard treatments	5.8
35	Shared public ways	5.8
36	Pedestrian-only streets	5.8
37	Public stairs	5.8
38	Above-ground landscaping	6.1





# Acknowledgements

The Better Streets Plan is a collaborative effort of many City departments and the public

## MAYOR

Gavin Newsom

## BOARD OF SUPERVISORS

David Chiu, *President*  
Michela Alioto-Pier  
John Avalos  
David Campos  
Carmen Chu  
Chris Daly  
Bevan Dufty  
Sean Elsbernd  
Eric Mar  
Sophie Maxwell  
Ross Mirkarimi

## DIRECTOR'S WORKING GROUP

Dean L. Macris  
*Chair, Director's Working Group*

Astrid Haryati  
*Director of City Greening, Co-chair Director's Working Group*

Nathaniel P. Ford, Sr.  
*Executive Director/Chief Executive Officer, San Francisco Municipal Transportation Agency*

Edward M. Harrington  
*General Manager, San Francisco Public Utilities Commission*

Edwin Lee  
*City Administrator*

Susan Mizner  
*Director, Mayor's Office on Disability*

Jose Luis Moscovich  
*Executive Director, San Francisco County Transportation Authority*

John Rahaim  
*Director, Planning Department*

Edward D. Reiskin  
*Director, Department of Public Works*

## BETTER STREETS PLAN COMMUNITY ADVISORY COMMITTEE

Jason Patton, *chair*

Pi Ra, *vice chair*

John Bela

Rene Bihan

Manish Champsee

Emily Drennen

Timothy Dunn

Alexandra Hernandez

Marcie Keever

Jessie Lorenz

Jane Martin

Roger Rose

Nancy Strahan

Amy Tanner

Amy Tran

## BETTER STREETS PLAN TEAM

### PLANNING DEPARTMENT

David Alumbaugh, *Manager, City Design Group*

Amit K. Ghosh, *Chief Planner*

Adam Varat, *Project Manager, Better Streets Plan*

Lisa Bender

Neil Hrushowy

Nicholas Perry

Andres Power

Gary Chen, *Graphic Designer*

### SAN FRANCISCO MUNICIPAL TRANSPORTATION AGENCY

Carter Rohan, *Senior Director, Transportation Planning & Development*

Bond Yee, *Director of Parking & Traffic*

Jack Fleck, *City Traffic Engineer*

Peter Albert, *Deputy Director of Planning*

Bridget Smith, *Manager, Livable Streets Program*

Cristina Olea, *past Pedestrian Program Manager*

Heath Maddox

Oliver Gajda, *Pedestrian Program Manager*

Sam Fielding

Frank Markowitz

Jon Swac

Britt Tanner

### DEPARTMENT OF PUBLIC WORKS

Edgar Lopez, *Manager, Project Management Division*

Kris Opbroek, *Project Manager, Great Streets Program*

### PUBLIC UTILITIES COMMISSION

Rosey Jencks

Sarah Minick

### MAYOR'S OFFICE ON DISABILITY

Joanna Fraguli

John Paul Scott

### DEPARTMENT OF PUBLIC HEALTH

Ana Validzic

Michael Radetsky

### SAN FRANCISCO COUNTY TRANSPORTATION AUTHORITY

Amber Crabbe

## BETTER STREETS PLAN TECHNICAL ADVISORY COMMITTEE

The Better Streets Plan Technical Advisory Committee consists of staff of the following agencies and departments:

Arts Commission  
Department of Public Health  
Department of Public Works  
Department of the Environment  
Fire Department  
Mayor's Office on Disability  
Office of Economic and Workforce Development  
Planning Department  
Police Department  
Port of San Francisco  
San Francisco County Transportation Authority  
San Francisco Municipal Transportation Agency  
San Francisco Public Utilities Commission  
San Francisco Redevelopment Agency

## BETTER STREETS PLAN TECHNICAL CONSULTANT TEAMS

### *Streetscape Master Plan technical consultants*

Community Design + Architecture  
Nelson\Nygaard Consulting Associates  
Sherwood Design Engineers  
Jacobs Macdonald Cityworks  
Eisen | Letunic  
Hydroconsult Engineers  
Parisi Associates  
Auerbach Glasow  
Nevue Ngan Associates  
Joe R. McBride  
MmM Design  
Urban Advantage

### *Pedestrian Master Plan technical consultants*

Fehr and Peers  
Nelson\Nygaard Consulting Associates  
Eisen | Letunic  
Expert panel: Dan Burden, Reid Ewing, Nazir Lalani, David Parisi, Jennifer Toole

### *Better Streets Plan Community Involvement Consultants*

Nelson\Nygaard Consulting Associates  
CirclePoint  
Independent Living Resource Center  
Lighthouse for the Blind and Visually Impaired  
Re/Bar  
Senior Action Network





THE BETTER STREETS PLAN WAS MADE POSSIBLE IN PART BY THE SAN FRANCISCO COUNTY TRANSPORTATION AUTHORITY THROUGH A GRANT OF PROPOSITION K LOCAL TRANSPORTATION SALES TAX FUNDS.

*Contact*

For more information on the Better Streets Plan, contact:

Adam Varat, Project Manager  
San Francisco Planning Department  
415.558.6405  
[adam.varat@sfgov.org](mailto:adam.varat@sfgov.org)

Visit our website at:

[www.sfbetterstreets.org](http://www.sfbetterstreets.org)

