

C:\Project.dwg\Van Ness BET 95% STIP & final base updated 6-10-15.dwg, CPT16401, T-1 str-6222 14 MARKERS&T-LINES Calltrans Typ Details.dwg, awong,3 Fri Jul 31, 2015 - 2:16 pm

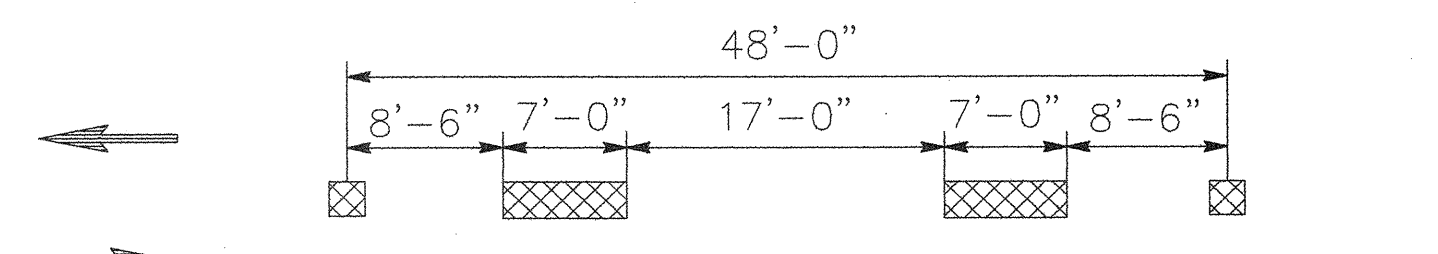

DETAIL 2: CENTERLINE ON TWO LANE CONVENTIONAL HIGHWAYS
(4" BY)

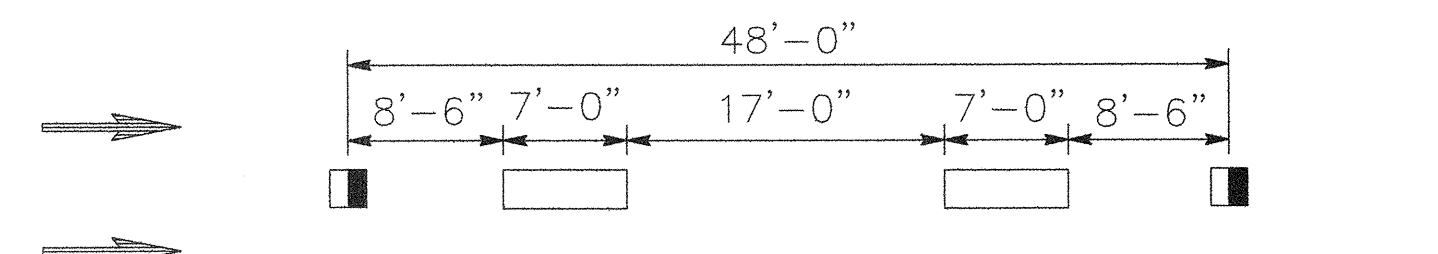

DETAIL 9: LANE LINE ON MULTILANE HIGHWAYS
(4" BW)

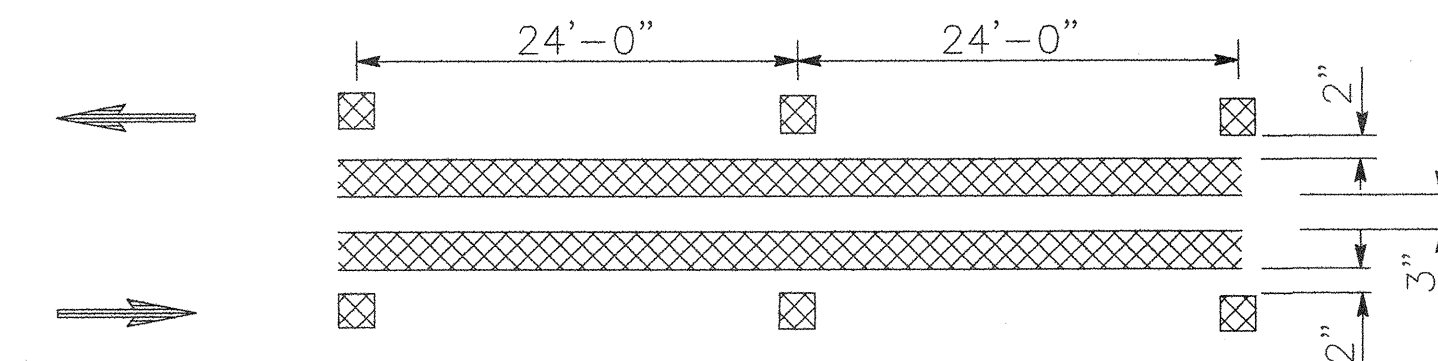

DETAIL 22: TWO-WAY NO PASSING ZONE WITH PAINTED STRIPE
(DY)

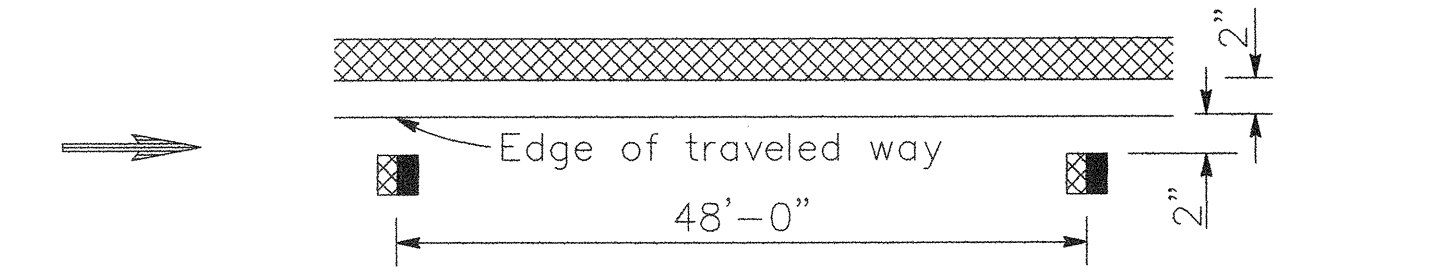

DETAIL 25: LEFT EDGE LINE (DIVIDED HIGHWAYS)
(4" SY)

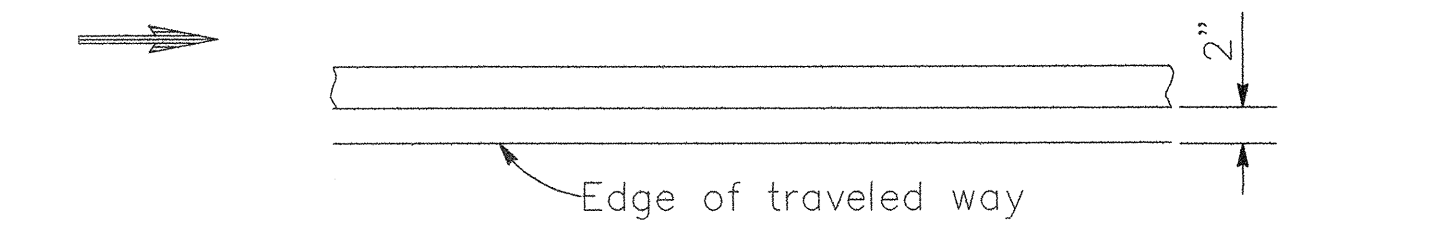

DETAIL 27B: RIGHT EDGE LINE
(4" SW)

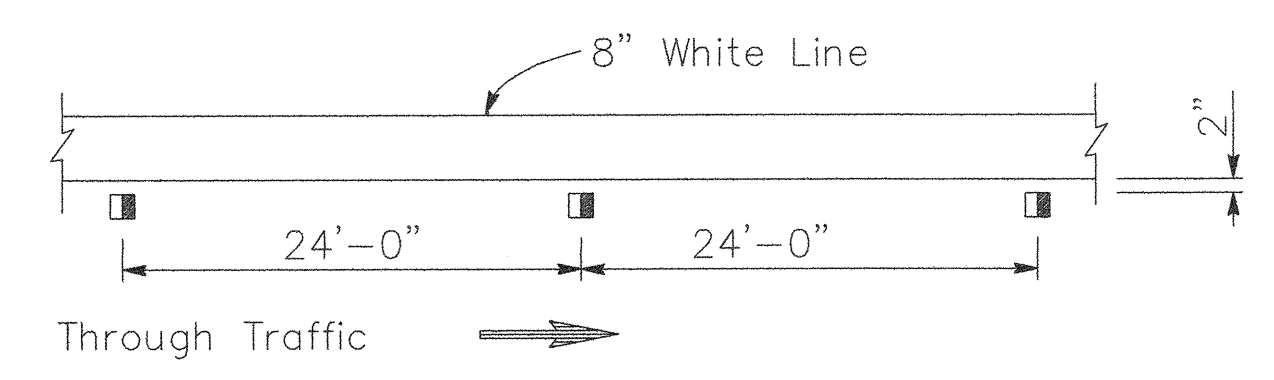

DETAIL 38: 8" WHITE CHANNELIZATION STRIPE
(8" SW FOR TURN POCKETS)

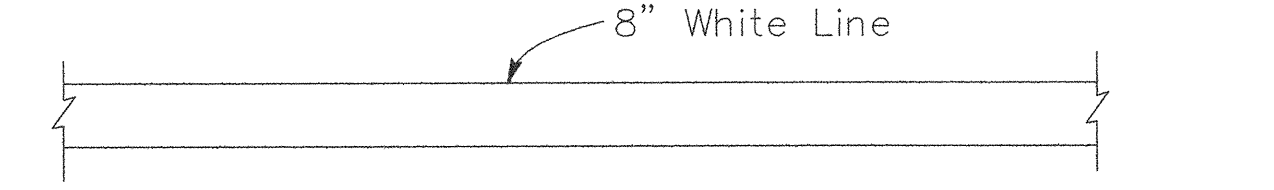

DETAIL 38: 8" SW

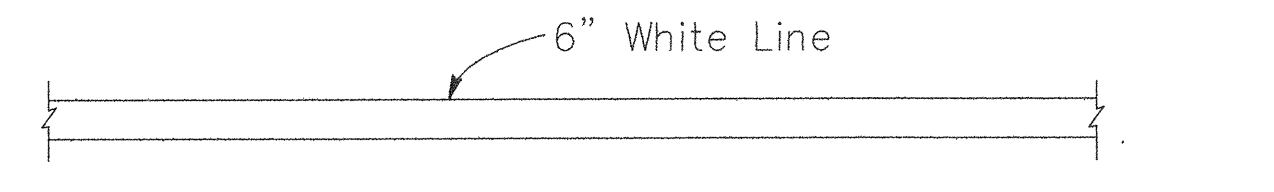

DETAIL 39: BIKE LANE LINE
(6" SW)

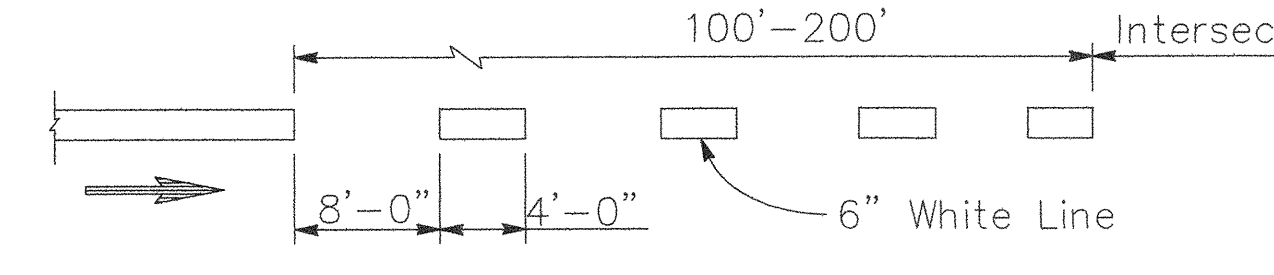

DETAIL 39A: BIKE LANE - INTERSECTION LINE
(6" BW)

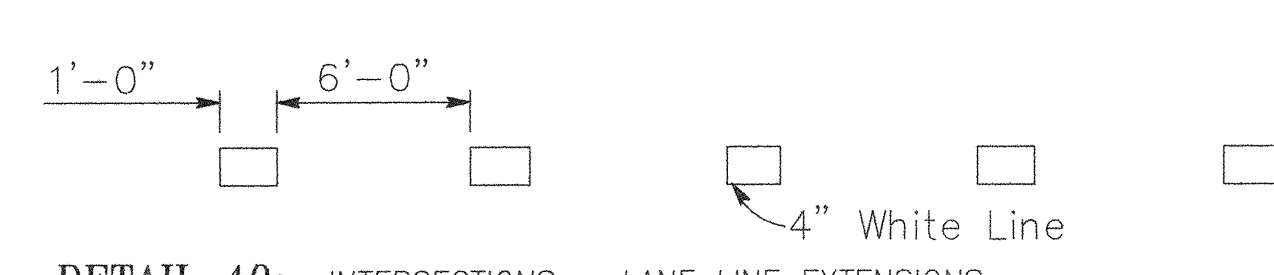

DETAIL 40: INTERSECTIONS - LANE LINE EXTENSIONS

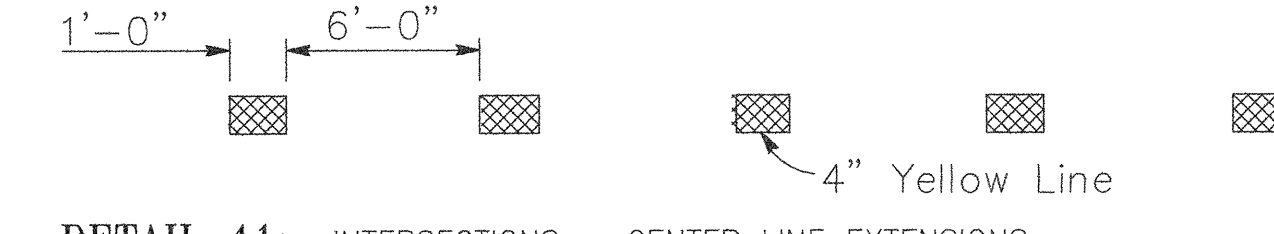

DETAIL 41: INTERSECTIONS - CENTER LINE EXTENSIONS

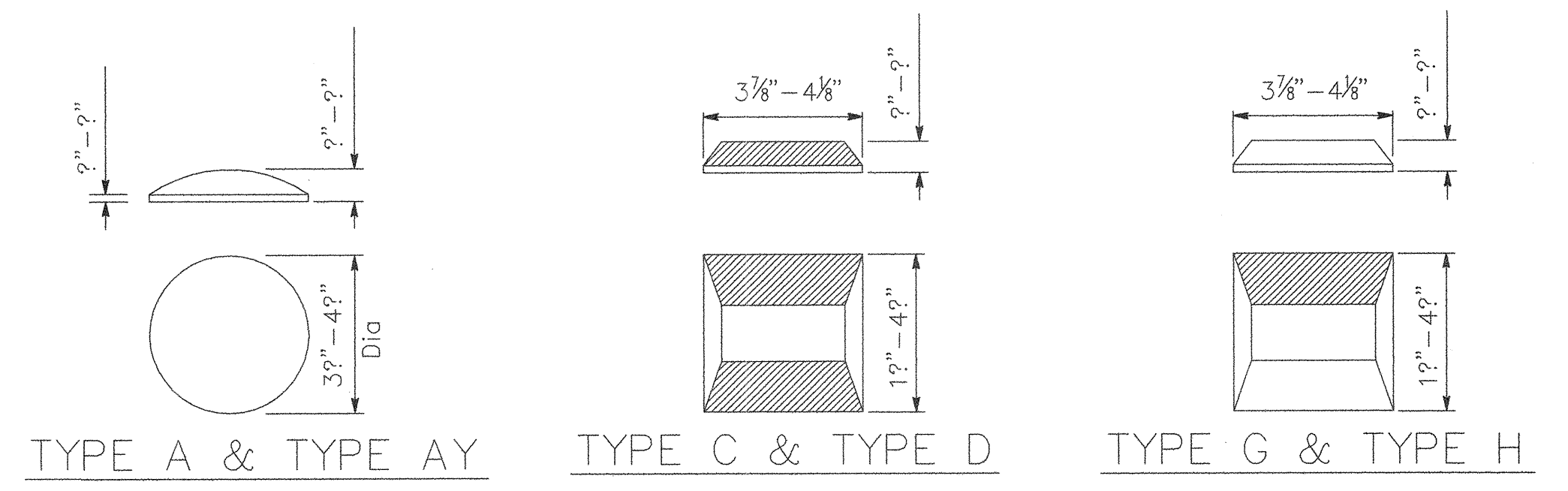

TYPE A & TYPE AY TYPE C & TYPE D TYPE G & TYPE H

Retroreflective Face **MARKER DETAILS**

LEGEND

- MARKERS**
- TYPE A White Non-reflective
 - ⊗ TYPE AY Yellow Non-reflective
 - ▣ TYPE C Red-clear Retroreflective
 - ⊠ TYPE D Two-way Yellow Retroreflective
 - ▢ TYPE G One-way Clear Retroreflective
 - ▣ TYPE H One-way Yellow Retroreflective
- LINES**
- ▬ 4" White
 - ▨ 4" Yellow
- ← Direction of Travel

NOTES:

1. PLACE REFLECTIVE MARKERS AT 48' INTERVALS ON TANGENTS AND ON CURVES OF 1000' RADIUS OR GREATER, AND AT 24' INTERVALS ON CURVES WITH LESS THAN 1000' RADIUS, UNLESS OTHERWISE SHOWN.
2. WHEN TYPE 'A' MARKERS ARE PLACED ON HIGHWAYS WITH EXISTING TRAFFIC STRIPE, LONGITUDINAL SPACINGS SHALL BE ADJUSTED SO THAT NON-REFLECTIVE MARKERS FALL ON THE STRIPE.

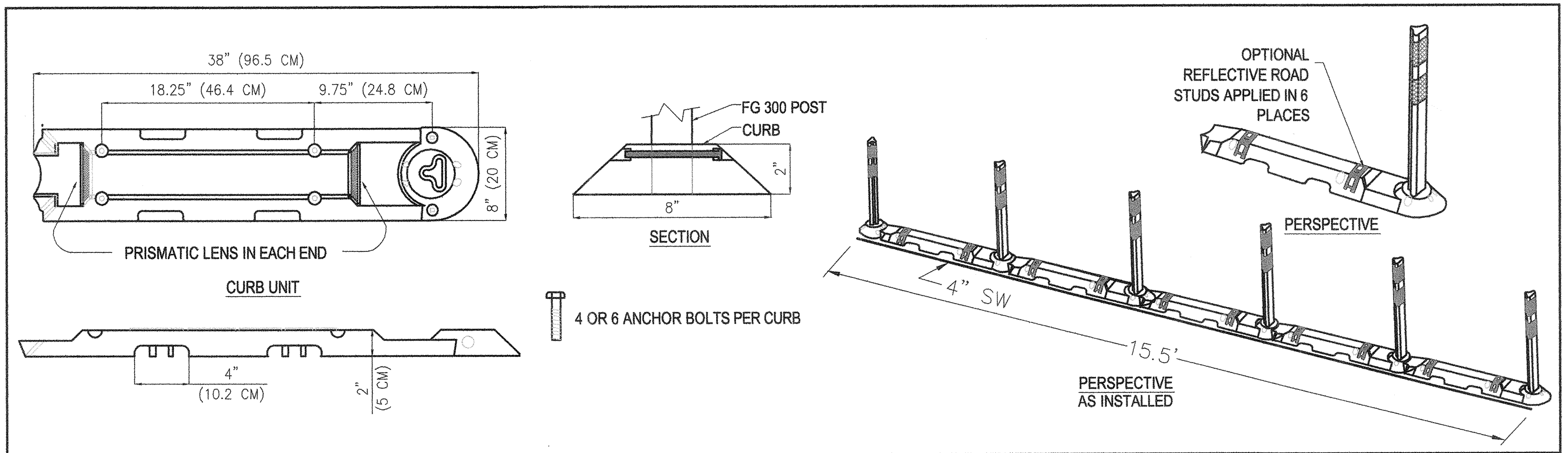

DETAIL A: 15.5' RAISED MOUNTABLE WHITE CURB DETAILS
(NTS)

NO.	DATE	DESCRIPTION	REVISED	CHECKED	APPROVED
REVISIONS					

DESIGNED: Komery 07-31-15
 DRAWN: Alamo 7-31-15
 CHECKED: [Signature] 7/31/15
 REVIEWED: [Signature] 7/31/2015
 RECOMMENDED: [Signature]
 APPROVED: [Signature] 11/24/2015
 DATE: MAY 19 2016

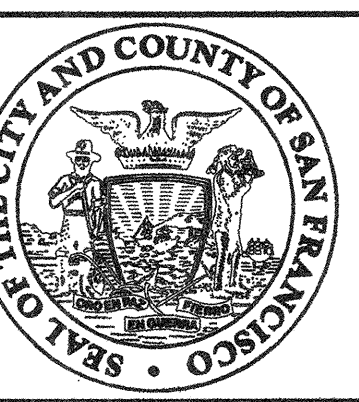
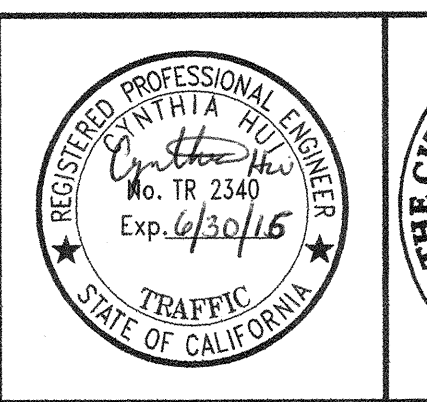

CITY AND COUNTY OF SAN FRANCISCO
MUNICIPAL TRANSPORTATION AGENCY

APPROVED: [Signature]
 for the DIRECTOR OF TRANSPORTATION

MUNI BUS RAPID TRANSIT SYSTEM
VAN NESS CORRIDOR TRANSIT IMPROVEMENT PROJECT

PAVEMENT MARKERS AND TRAFFIC LINES
 TYPICAL DETAILS

1289	
T-1	REVISION
T-13	0

T:\T_E_FILES\Construction\Section_PERSONNEL\VPY temp\VAN_NESS_BRT\95X STRIP & final base updated 6-10-15 aw_CPT6401_T2-T7.dwg ppyuen Fri Jul 31 2015 10:34 am

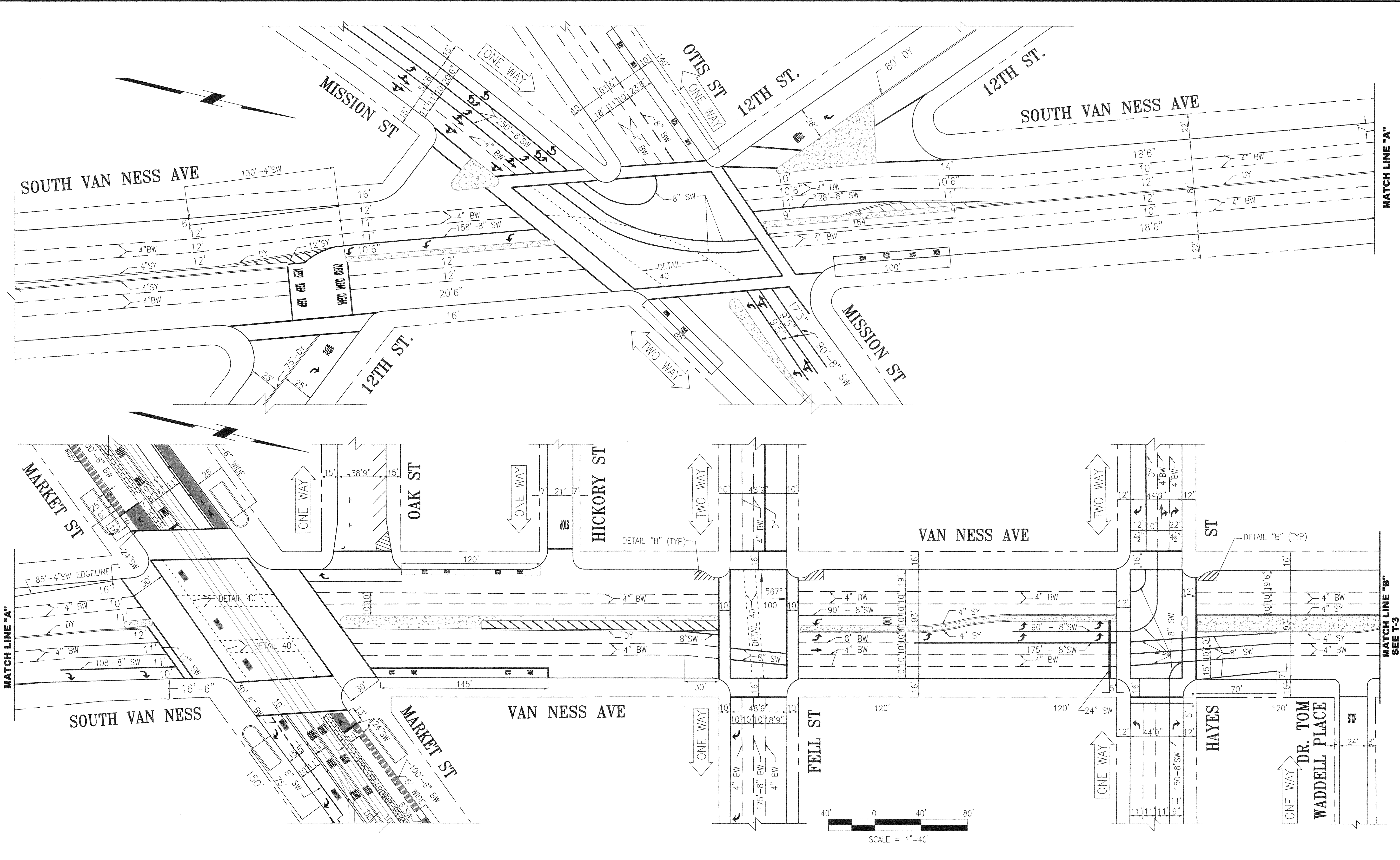

NO.	DATE	DESCRIPTION	REVISED	CHECKED	APPROVED
REVISIONS					

DESIGNED: *Kimberly* 073145
 DRAWN: *R. S. R.* 7-31-15
 CHECKED: *Cynthia* 7/31/15
 REVIEWED: *[Signature]* 7/31/2015
 RECOMMENDED: *[Signature]*
 APPROVED: *R. O.* 11/24/2015
 DATE: **MAY 19 2016**

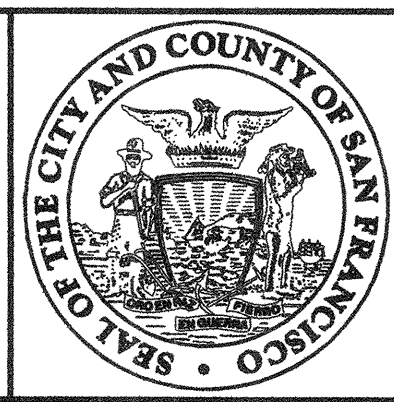

CITY AND COUNTY OF SAN FRANCISCO
MUNICIPAL TRANSPORTATION AGENCY
 APPROVED: *[Signature]*
 for the DIRECTOR OF TRANSPORTATION

MUNI BUS RAPID TRANSIT SYSTEM
VAN NESS CORRIDOR TRANSIT IMPROVEMENT PROJECT
 EXISTING TRAFFIC STRIPING PLAN
 S. VAN NESS AVE FROM 12TH ST TO VAN NESS LECH WALESA ST

1289	REVISION
T-2	0
T-13	

T:\E_FILES\Construction Section\PERSONNEL\VPY temp\VAN NESS BRITV85Z STRP & final base updated 6-10-15 am\CPTE601 T2-T7.dwg ppyten Fri Jul 31 2015 10:37 am

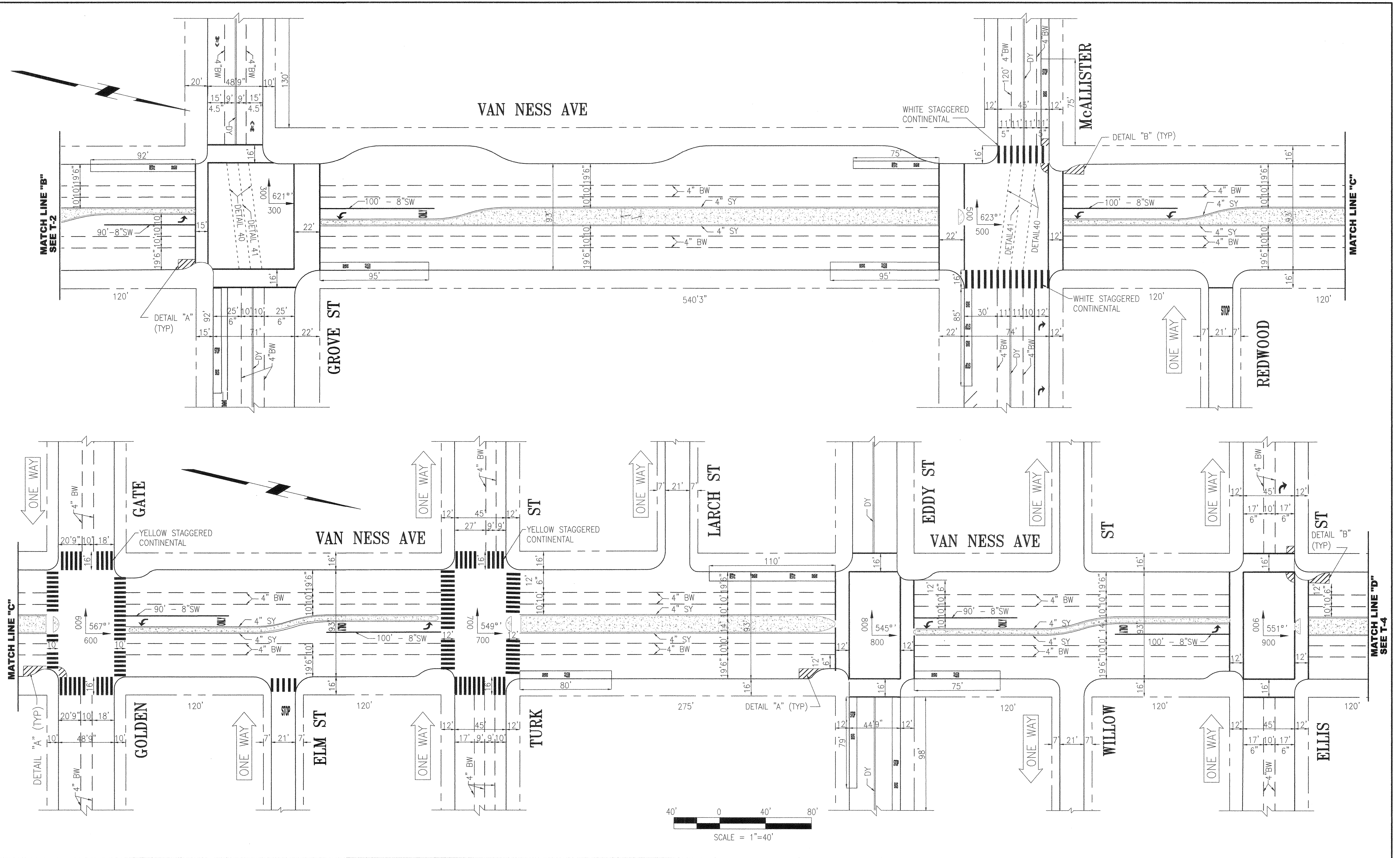

NO.	DATE	DESCRIPTION	REVISED	CHECKED	APPROVED
REVISIONS					

DESIGNED: <i>Km...</i> 07/31/15
DRAWN: <i>R.P.S.</i> 7-31-15
CHECKED: <i>C.H.H.</i> 7/31/15
REVIEWED: <i>[Signature]</i> 7/31/15
RECOMMENDED: <i>[Signature]</i>
APPROVED: <i>[Signature]</i> 4/24/2015
DATE: MAY 13 2016

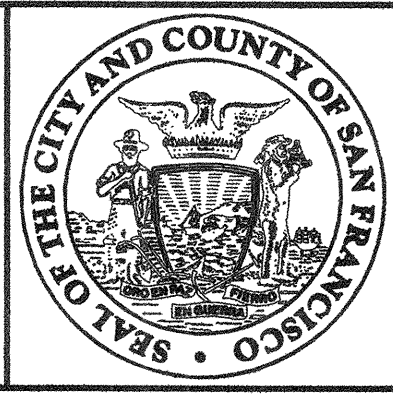
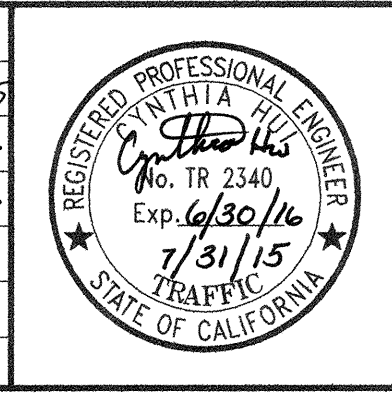

CITY AND COUNTY OF SAN FRANCISCO
MUNICIPAL TRANSPORTATION AGENCY

APPROVED
[Signature]
 for the DIRECTOR OF TRANSPORTATION

MUNI BUS RAPID TRANSIT SYSTEM
VAN NESS CORRIDOR TRANSIT IMPROVEMENT PROJECT

EXISTING TRAFFIC STRIPING PLAN
 VAN NESS AVE FROM GROVE ST TO ELLIS ST

1289	REVISION
T-3	0
T-13	

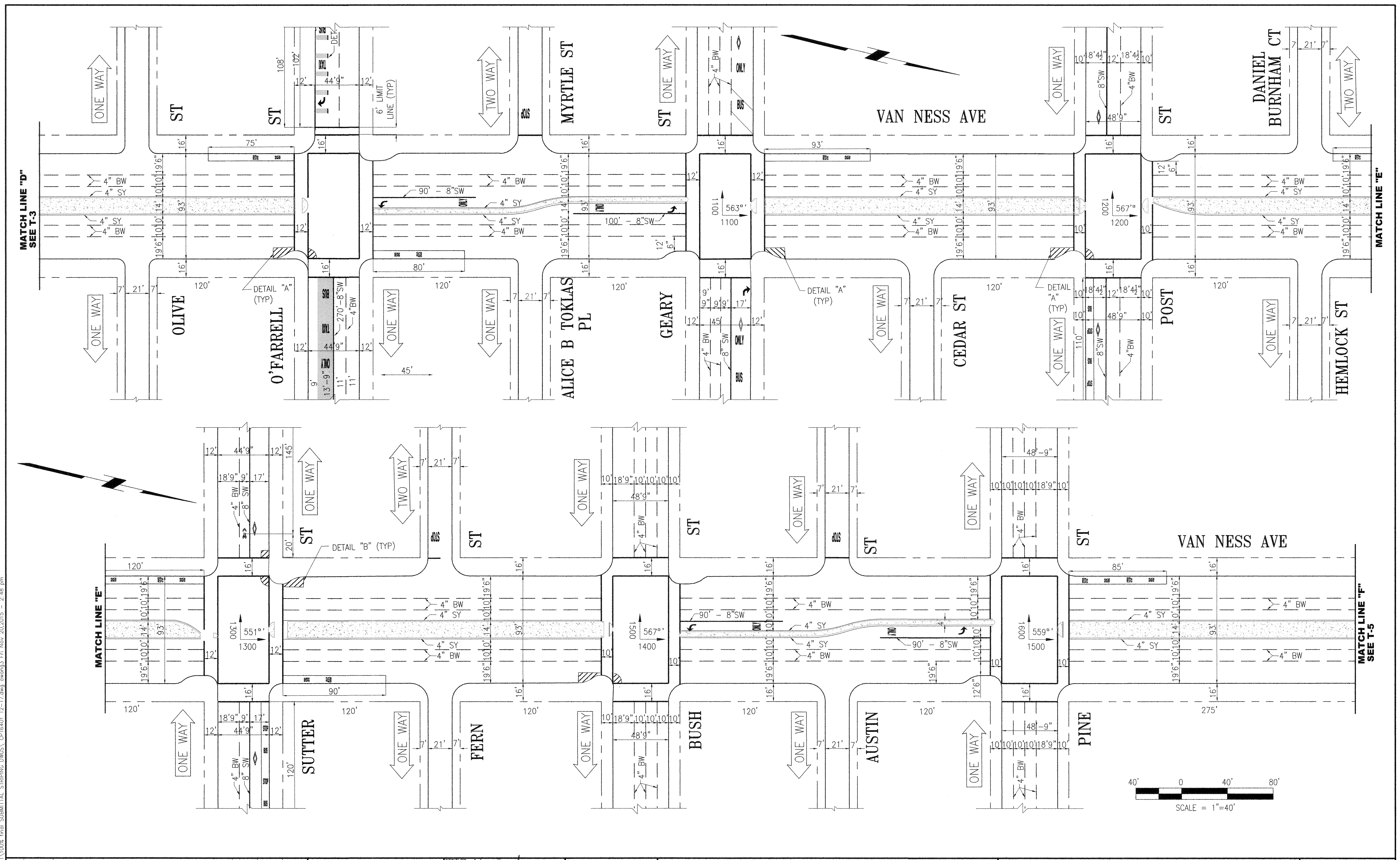

C:\project\dwgs\Van Ness BR\100% final SUBMITTAL STRIPING DWGS\ CPT6401 12-17.dwg awwg3 Fri Nov 20 2015 - 2:48 pm
 BORDER REVISED 11/17/05

NO.	DATE	DESCRIPTION	REVISED	CHECKED	APPROVED
REVISIONS					

DESIGNED	<i>[Signature]</i>	11-23-15
DRAWN	<i>[Signature]</i>	11-23-15
CHECKED	<i>[Signature]</i>	11/23/15
REVIEWED	<i>[Signature]</i>	11/23/2015
RECOMMENDED	<i>[Signature]</i>	11/23/2015
APPROVED	<i>[Signature]</i>	11/23/15
DATE	MAY 13 2016	

REGISTERED PROFESSIONAL ENGINEER
 No. TR 2340
 Exp. 6/30/16
 STATE OF CALIFORNIA

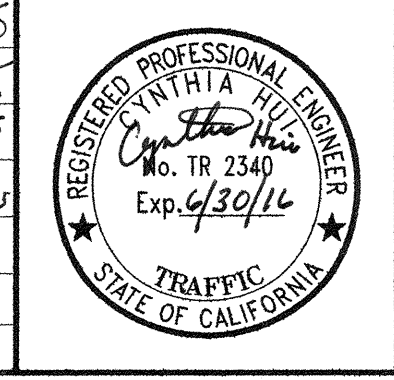

CITY AND COUNTY OF SAN FRANCISCO
MUNICIPAL TRANSPORTATION AGENCY

APPROVED
[Signature]
 for the DIRECTOR OF TRANSPORTATION

MUNI BUS RAPID TRANSIT SYSTEM
VAN NESS CORRIDOR TRANSIT IMPROVEMENT PROJECT
 EXISTING TRAFFIC STRIPING PLAN
 VAN NESS AVE FROM OLIVE ST TO PINE ST

1289	
T-4	REVISION
T-13	0

T:\T-E_FILES\Construction Section\PERSONNEL\VPY Temp\VAN_NESS_BRT_95%_STRIP_&_final_base_updated_6-10-15.dwg, CPT6401_T2-T7.dwg, ppvuen Fri Jul 31, 2015 - 10:39 am

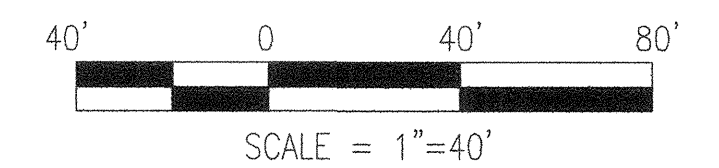
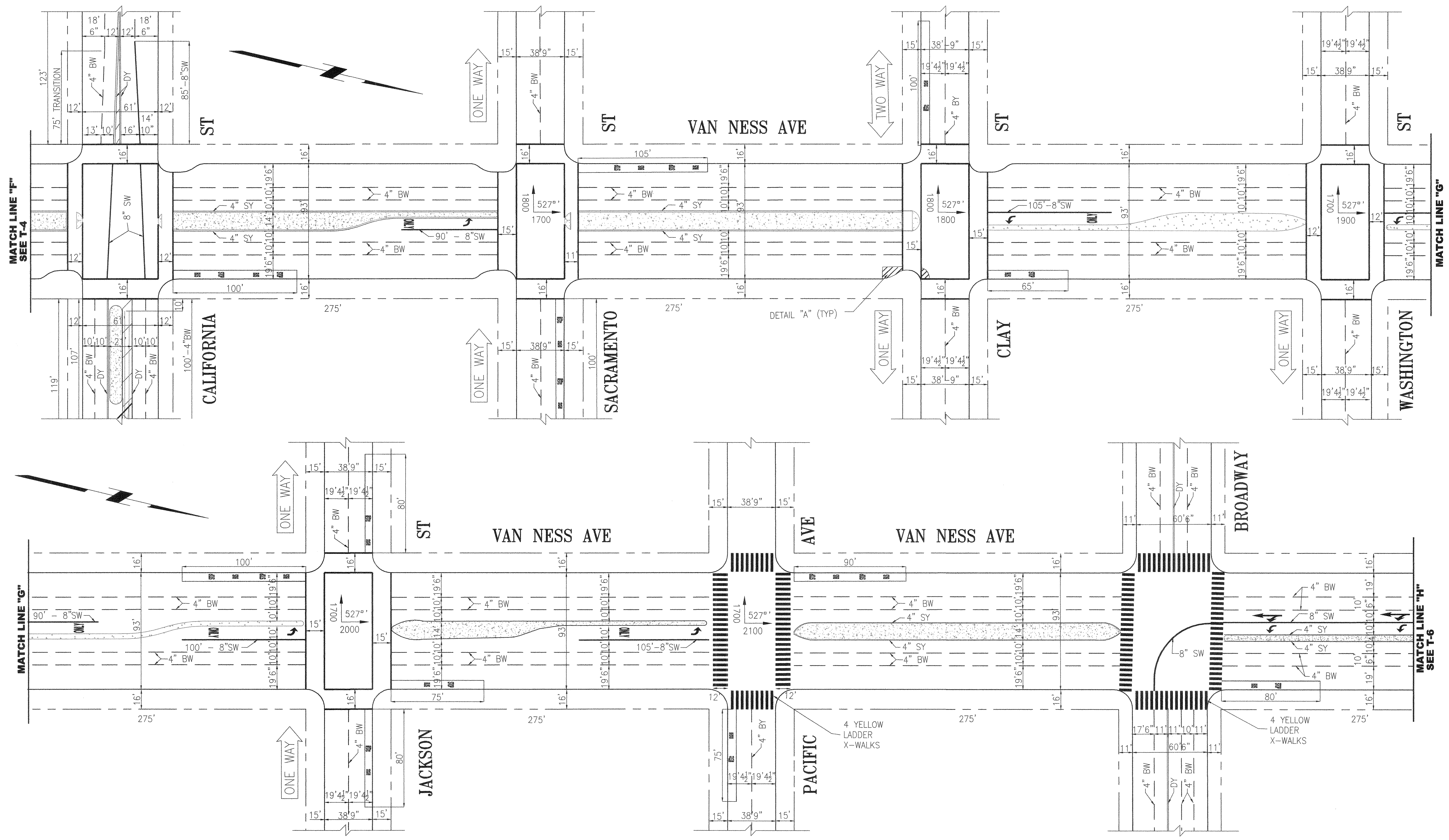

NO.	DATE	DESCRIPTION	REVISED	CHECKED	APPROVED
REVISIONS					

DESIGNED: *Kimberly* 0731-15
 DRAWN: *R3 Roy* 7-31-15
 CHECKED: *Quinn Ho* 7/31/15
 REVIEWED: *[Signature]* 7/31/2015
 RECOMMENDED: *[Signature]*
 APPROVED: *ROLO* 11/24/2015
 DATE: **MAY 13 2016**

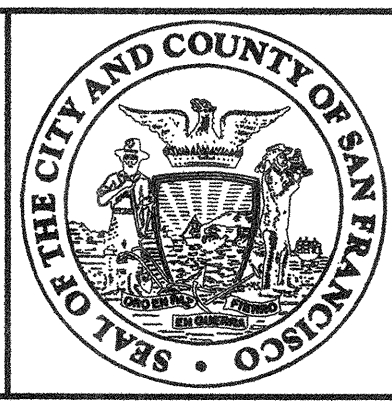
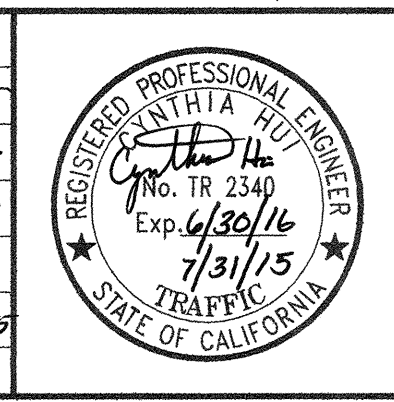

CITY AND COUNTY OF SAN FRANCISCO
MUNICIPAL TRANSPORTATION AGENCY

APPROVED
[Signature]
 for the DIRECTOR OF TRANSPORTATION

MUNI BUS RAPID TRANSIT SYSTEM
VAN NESS CORRIDOR TRANSIT IMPROVEMENT PROJECT

EXISTING TRAFFIC STRIPING PLAN
 VAN NESS AVE FROM CALIFORNIA ST TO BROADWAY

1289	REVISION
T-5	0
T-13	

T:\V.E. FILES\Construction Section\PERSONNEL\PPY temp\VAN_NESS BRT 95% STRIP & final base updated 6-10-15 av\CP76401 T2-17.dwg ppytem Fri Jul 31 2015 - 10:40 am
 BORDER REVISED 11/17/05

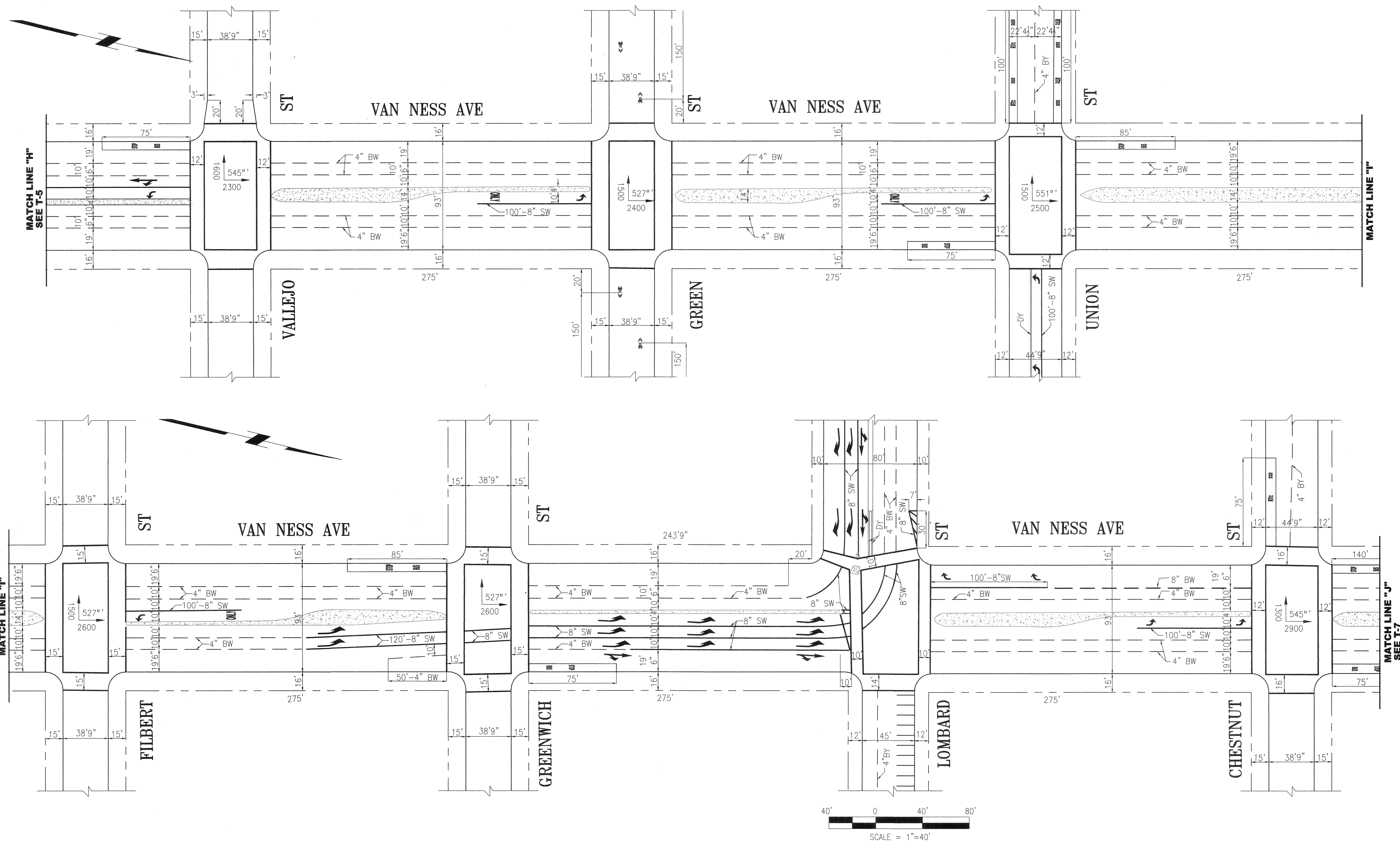

NO.	DATE	DESCRIPTION	REVISED	CHECKED	APPROVED

DESIGNED: *Kimberly J. 073115*
 DRAWN: *Rob P. 7-31-15*
 CHECKED: *Antonia H. 7/31/15*
 REVIEWED: *[Signature] 7/31/2015*
 RECOMMENDED: *[Signature]*
 APPROVED: *Robea 11/24/2015*
 DATE: **MAY 13 2016**

REGISTERED PROFESSIONAL ENGINEER
 ANTONIA H. TRIPIA
 No. TR 2340
 Exp. 4/30/16
 7/31/15
 TRAFFIC ENGINEER
 STATE OF CALIFORNIA

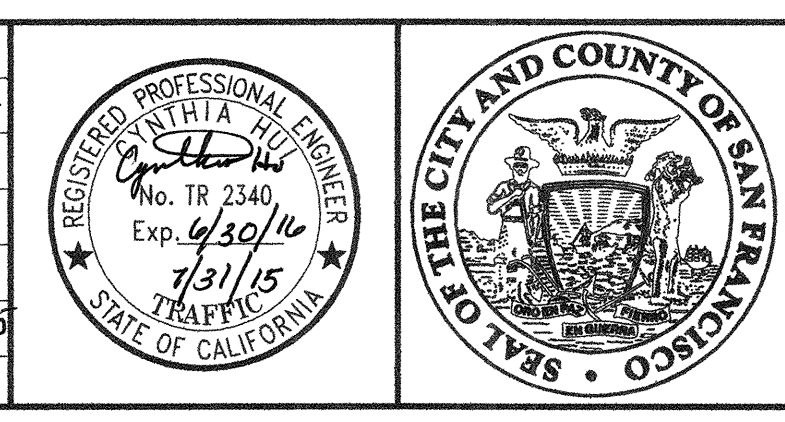

CITY AND COUNTY OF SAN FRANCISCO
MUNICIPAL TRANSPORTATION AGENCY
 APPROVED
[Signature]
 for the DIRECTOR OF TRANSPORTATION

MUNI BUS RAPID TRANSIT SYSTEM
VAN NESS CORRIDOR TRANSIT IMPROVEMENT PROJECT
 EXISTING TRAFFIC STRIPING PLAN
 VAN NESS AVE FROM VALLEJO ST TO CHESTNUT ST

1289	REVISION
T-6	0
T-13	0

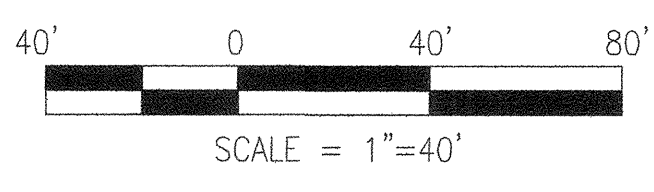
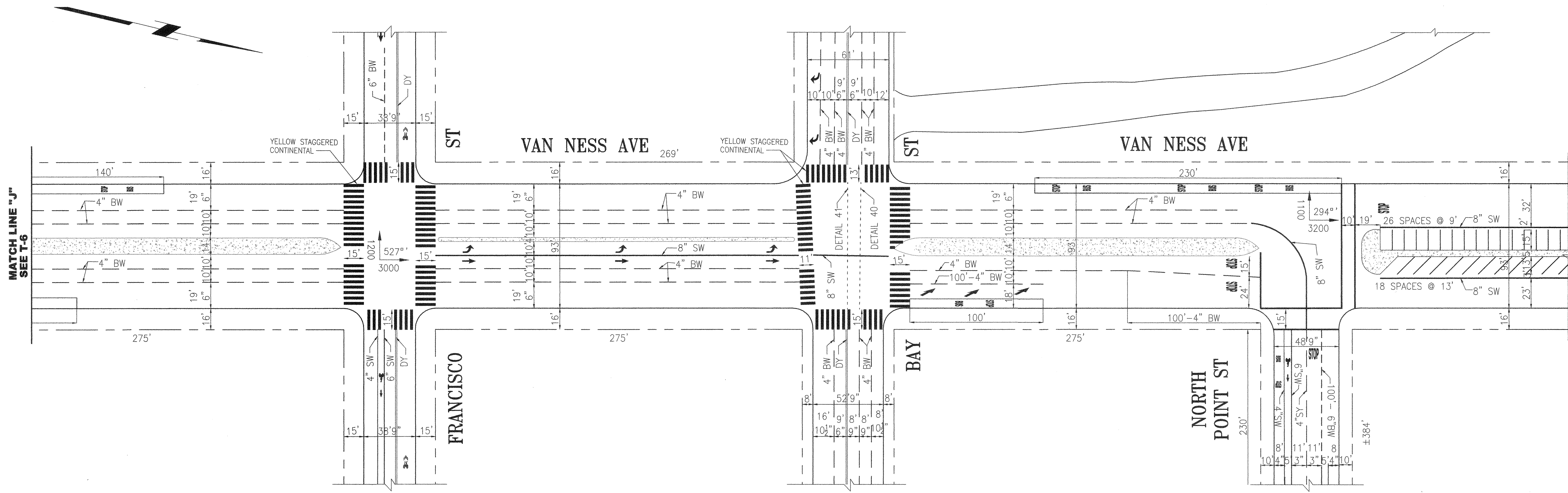

I:\T_E_FILES\Construction Section\PERSONNEL\PPY temp\VAN NESS BRT\95% STRIP & final base updated 6-10-15 ow\DP16401_T2-17.dwg ppwuen Fri Jul 31 2015 10:40 am

NO.	DATE	DESCRIPTION	REVISED	CHECKED	APPROVED

DESIGNED	DRAWN	CHECKED	REVIEWED	RECOMMENDED	APPROVED	DATE
<i>Km...</i>	<i>...</i>	<i>...</i>	<i>...</i>	<i>...</i>	<i>Rdea</i>	MAY 13 2016

DESIGNED: *Km...* 07/31/15
 DRAWN: *...* 7-31-15
 CHECKED: *...* 7/31/15
 REVIEWED: *...* 7/31/2015
 RECOMMENDED: *...*
 APPROVED: *Rdea* 4/24/2015
 DATE: MAY 13 2016



CITY AND COUNTY OF SAN FRANCISCO
MUNICIPAL TRANSPORTATION AGENCY
 APPROVED
 for the DIRECTOR OF TRANSPORTATION

MUNI BUS RAPID TRANSIT SYSTEM
VAN NESS CORRIDOR TRANSIT IMPROVEMENT PROJECT
 EXISTING TRAFFIC STRIPING PLAN
 VAN NESS AVE FROM FRANCISCO ST TO NORTH POINT ST

1289	REVISION
T-7	0
T-13	0

T:_FILES\Construction Section\PERSONNEL\PPY temp\VAN NESS BRT\100% STRP & final base updated 6-10-15 caw\CP18401 TR-T13.dwg overng3 Mon Aug 03 2015 - 4.06 pm

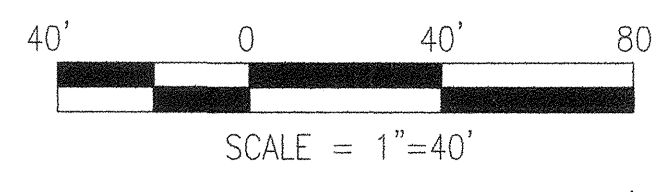
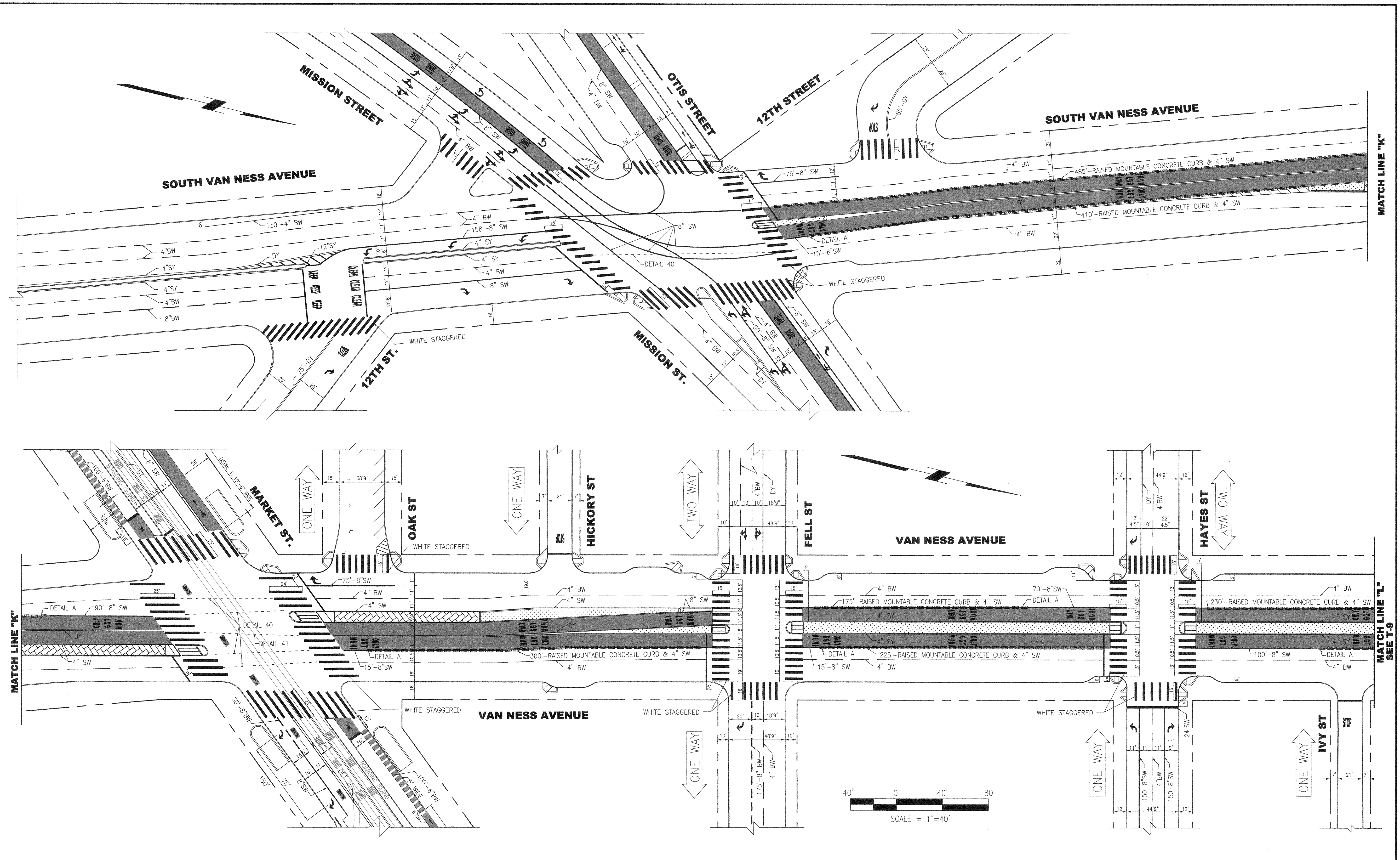

NO.	DATE	DESCRIPTION	REVISED	CHECKED	APPROVED
REVISIONS					

DESIGNED	<i>Kmiero</i> 07/31/15
DRAWN	<i>Wiley</i> 7/31/15
CHECKED	<i>Wiley</i> 7/31/15
RECOMMENDED	<i>Wiley</i> 7/31/15
APPROVED	<i>Rosen</i> 4/24/2015
DATE	MAY 13 2016

REGISTERED PROFESSIONAL ENGINEER
 ANTHONIA HILL
 No. TR 2340
 Exp. 6/30/16
 STATE OF CALIFORNIA
 TRAFFIC

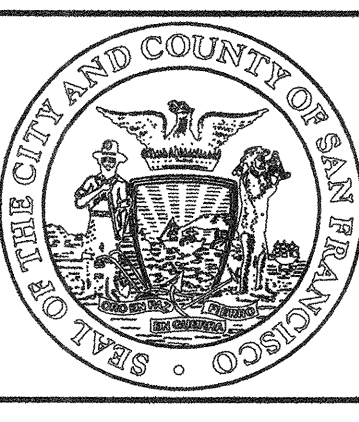
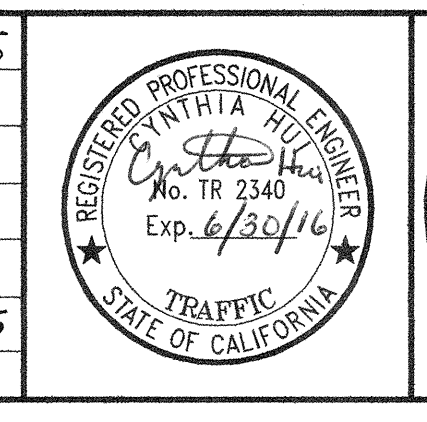

CITY AND COUNTY OF SAN FRANCISCO
MUNICIPAL TRANSPORTATION AGENCY
 APPROVED
 [Signature]
 for the DIRECTOR OF TRANSPORTATION

MUNI BUS RAPID TRANSIT SYSTEM
VAN NESS CORRIDOR TRANSIT IMPROVEMENT PROJECT
 FINAL TRAFFIC STRIPING PLAN
 S. VAN NESS AVE FROM 12TH ST TO VAN NESS LECH WALESA ST

1289	REVISION
T-8	0
T-13	0

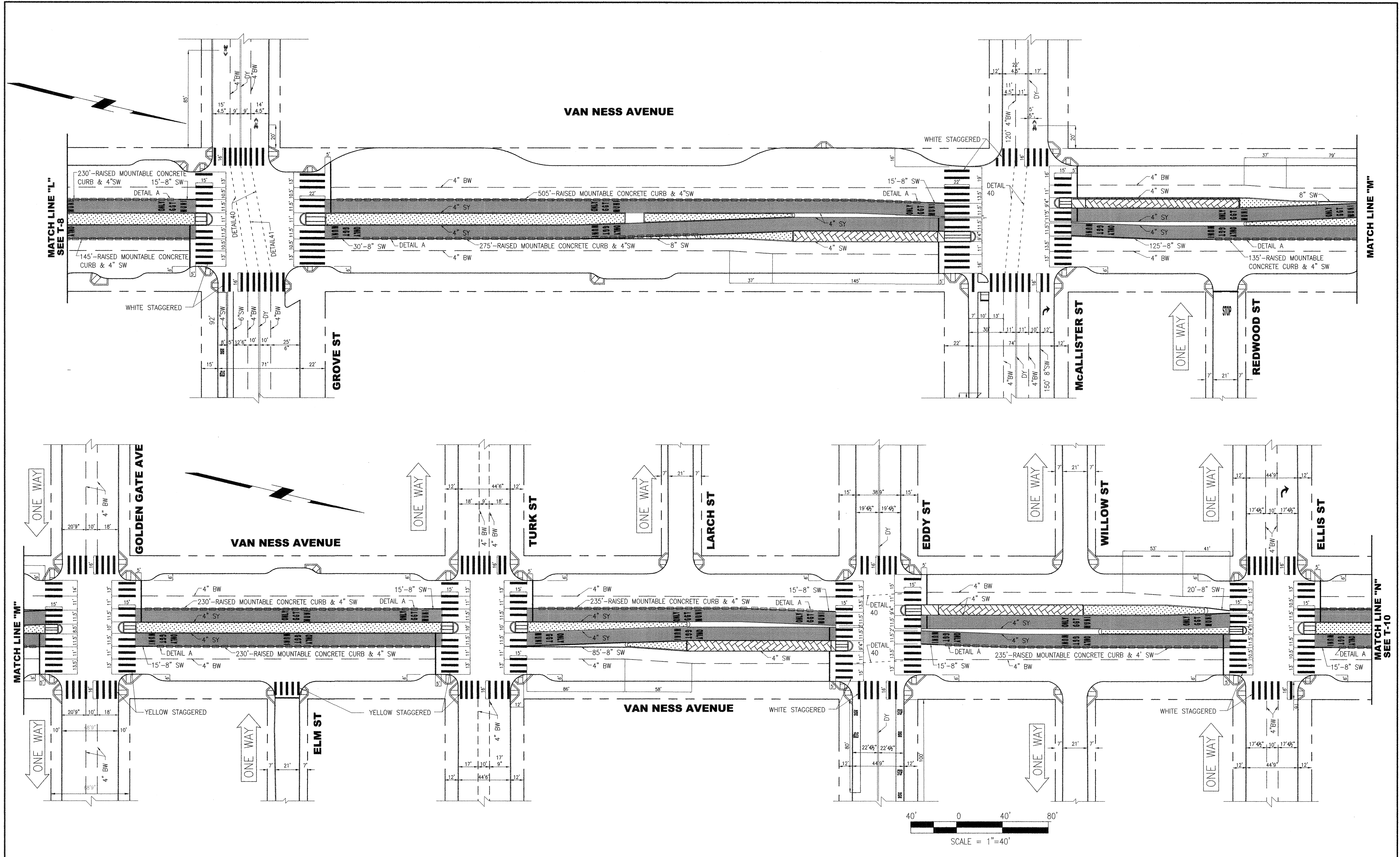

C:\project\drags\Van Ness BR\100% final SUBMITTAL STRIPING DWGS\ CPT6401 TB-T13.dwg anong3 Fri Nov 20,2015 - 2:53 pm
 BORDER REVISED 11/17/05

NO.	DATE	DESCRIPTION	REVISED	CHECKED	APPROVED
REVISIONS					

DESIGNED	<i>[Signature]</i> 11-23-15
DRAWN	<i>[Signature]</i> 11-23-15
CHECKED	<i>[Signature]</i> 11/23/15
REVIEWED	<i>[Signature]</i> 11/20/2015
RECOMMENDED	<i>[Signature]</i>
APPROVED	<i>[Signature]</i> 11/24/2015
DATE	MAY 13 2016

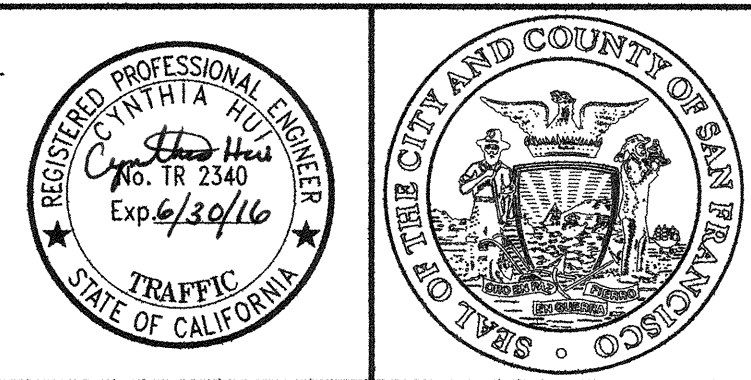
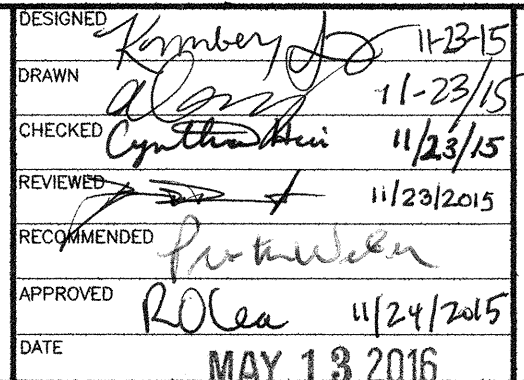

CITY AND COUNTY OF SAN FRANCISCO
MUNICIPAL TRANSPORTATION AGENCY

APPROVED
[Signature]
 for the DIRECTOR OF TRANSPORTATION

MUNI BUS RAPID TRANSIT SYSTEM
VAN NESS CORRIDOR TRANSIT IMPROVEMENT PROJECT

FINAL TRAFFIC STRIPING PLAN
 VAN NESS AVE FROM GROVE ST TO ELLIS ST

1289	REVISION
T-9	0
T-13	

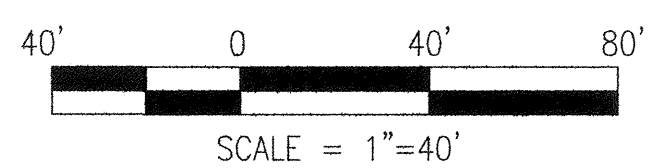
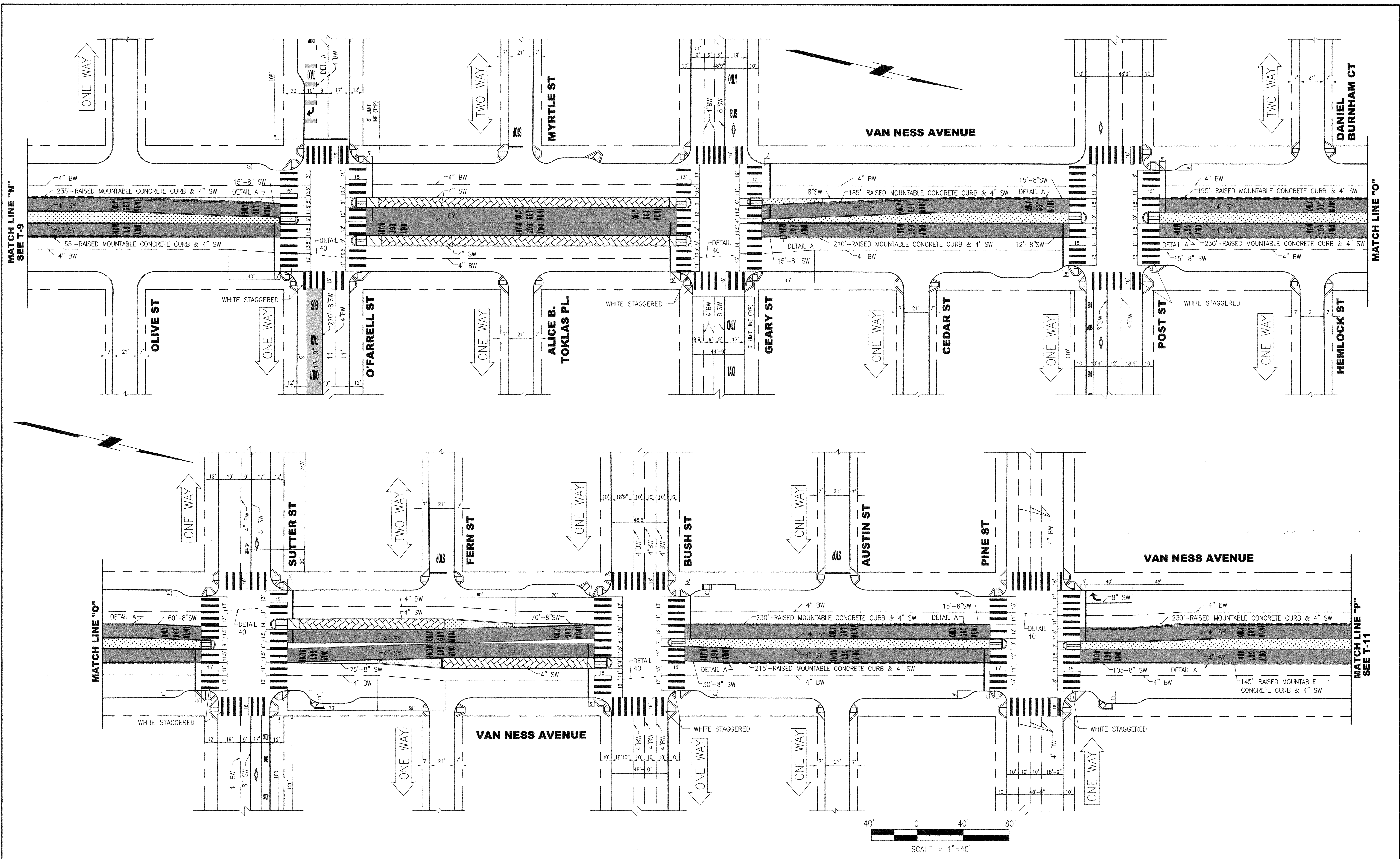

NO.	DATE	DESCRIPTION	REVISED	CHECKED	APPROVED
REVISIONS					

DESIGNED	<i>[Signature]</i>	11/23/15
DRAWN	<i>[Signature]</i>	11/23/15
CHECKED	<i>[Signature]</i>	11/23/15
REVIEWED	<i>[Signature]</i>	11/23/2015
RECOMMENDED	<i>[Signature]</i>	
APPROVED	<i>[Signature]</i>	11/24/2015
DATE		MAY 13 2016

DESIGNED *[Signature]* 11/23/15
 DRAWN *[Signature]* 11/23/15
 CHECKED *[Signature]* 11/23/15
 REVIEWED *[Signature]* 11/23/2015
 RECOMMENDED *[Signature]*
 APPROVED *[Signature]* 11/24/2015
 DATE MAY 13 2016

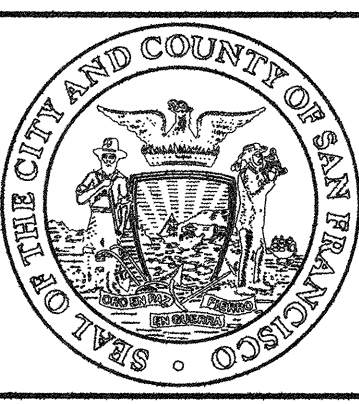
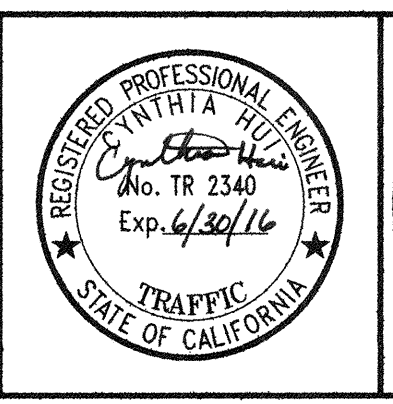

CITY AND COUNTY OF SAN FRANCISCO
MUNICIPAL TRANSPORTATION AGENCY
 APPROVED
[Signature]
 for the DIRECTOR OF TRANSPORTATION

MUNI BUS RAPID TRANSIT SYSTEM
VAN NESS CORRIDOR TRANSIT IMPROVEMENT PROJECT
 FINAL TRAFFIC STRIPING PLAN
 VAN NESS AVE FROM OLIVE ST TO PINE ST

1289	REVISION
T-10	0
T-13	

C:\project\dwgs\Van Ness BRT\100% final SUBMITTAL STRIPING DWGS\CPT6401 TB-T13.dwg awong3 Fri Nov 20, 2015 - 2:51 pm
 BORDER REVISED 11/17/05

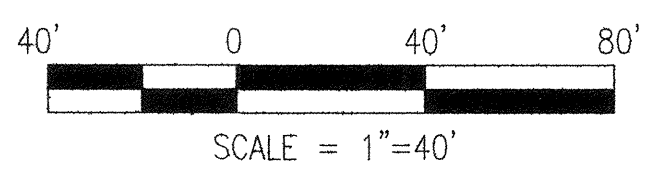
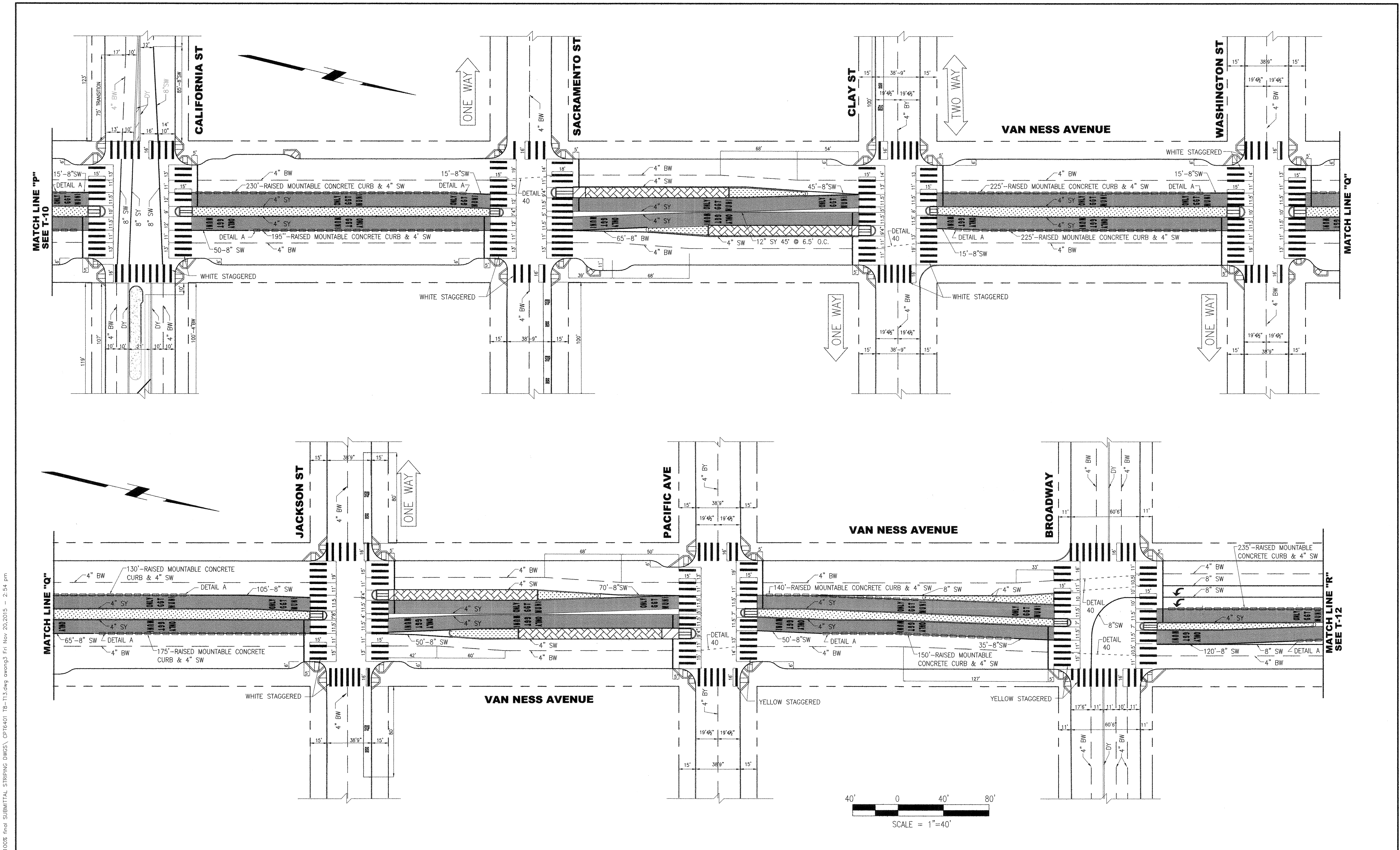

NO.	DATE	DESCRIPTION	REVISED	CHECKED	APPROVED
REVISIONS					

DESIGNED	<i>Km...</i>	11/23/15
DRAWN	<i>...</i>	11/23/15
CHECKED	<i>...</i>	11/23/15
REVIEWED	<i>...</i>	11/23/2015
RECOMMENDED	<i>...</i>	
APPROVED	<i>...</i>	11/24/2015
DATE		MAY 13 2016

REGISTERED PROFESSIONAL ENGINEER
 CIVIL
 No. TR 2340
 Exp. 6/30/16
 STATE OF CALIFORNIA

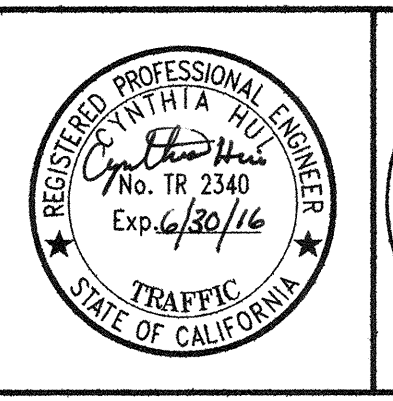

CITY AND COUNTY OF SAN FRANCISCO
MUNICIPAL TRANSPORTATION AGENCY

APPROVED
[Signature]
 for the DIRECTOR OF TRANSPORTATION

MUNI BUS RAPID TRANSIT SYSTEM
VAN NESS CORRIDOR TRANSIT IMPROVEMENT PROJECT

FINAL TRAFFIC STRIPING PLAN
 VAN NESS AVE FROM CALIFORNIA ST TO BROADWAY

1289	
T-11	REVISION
T-13	0

C:\project\dwgs\Van Ness BR\1008 final SUBMITTAL STRIPING DWGS\ CPT16401 TR-113.dwg among3 Fri Nov 20 2015 2:54 pm
 BORDER REVISED 11/17/05

C:_Project_dwg\Van Ness BRT\100% Final SUBMITTAL STRIPING DWGS\ CP16401_TB-T13.dwg, awong3, Mon Nov 23, 2015 - 8:49 am

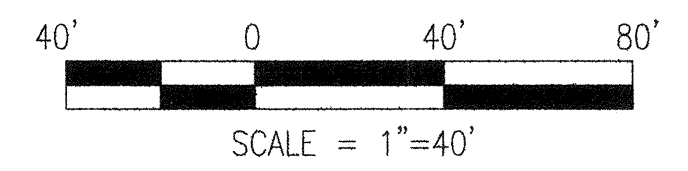
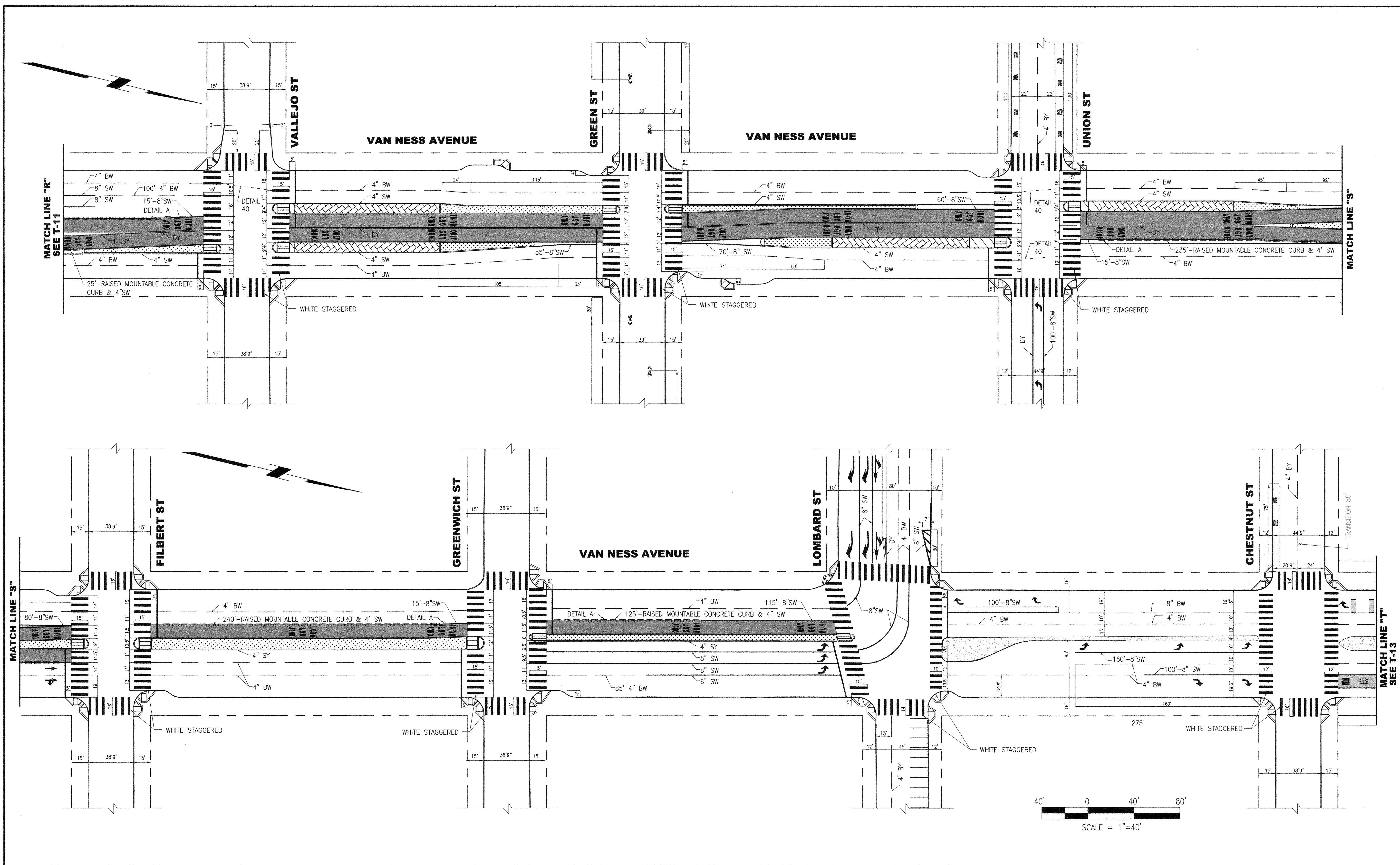

NO.	DATE	DESCRIPTION	REVISED	CHECKED	APPROVED
REVISIONS					

DESIGNED	<i>Kimmy</i> 11/23/15
DRAWN	<i>albert</i> 11/23/15
CHECKED	<i>Christina</i> 11/23/15
REVIEWED	<i>Paul</i> 11/23/15
RECOMMENDED	<i>Paul</i> 11/23/15
APPROVED	<i>Paul</i> 11/24/15
DATE	MAY 13 2016

REGISTERED PROFESSIONAL ENGINEER
 CIVIL
 No. TR 2340
 Exp. 6/30/16
 STATE OF CALIFORNIA

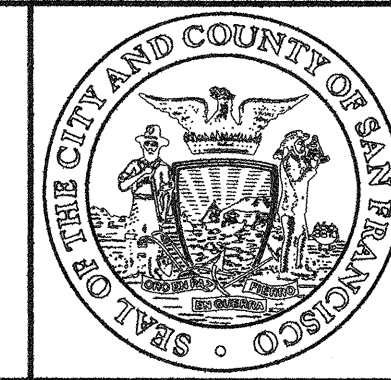

CITY AND COUNTY OF SAN FRANCISCO
MUNICIPAL TRANSPORTATION AGENCY

APPROVED
[Signature]
 for the DIRECTOR OF TRANSPORTATION

MUNI BUS RAPID TRANSIT SYSTEM		1289
VAN NESS CORRIDOR TRANSIT IMPROVEMENT PROJECT		
FINAL TRAFFIC STRIPING PLAN VAN NESS AVE FROM VALLEJO ST TO CHESTNUT ST		T-12
		T-13
		REVISION 0

T:\T_E_FILES\Construction\Section\PERSONNEL\PPY\Temp\VAN_NESS_BRT\100%_STRP & final_base updated 6-10-15 om\CP16401_T8-T13.dwg awong3 Mon Aug 03,2015 - 4:09 pm

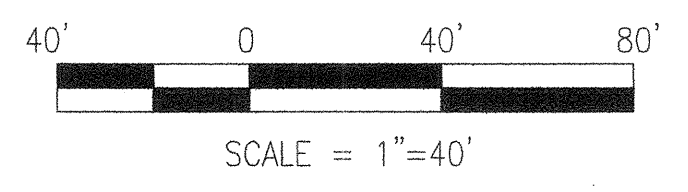
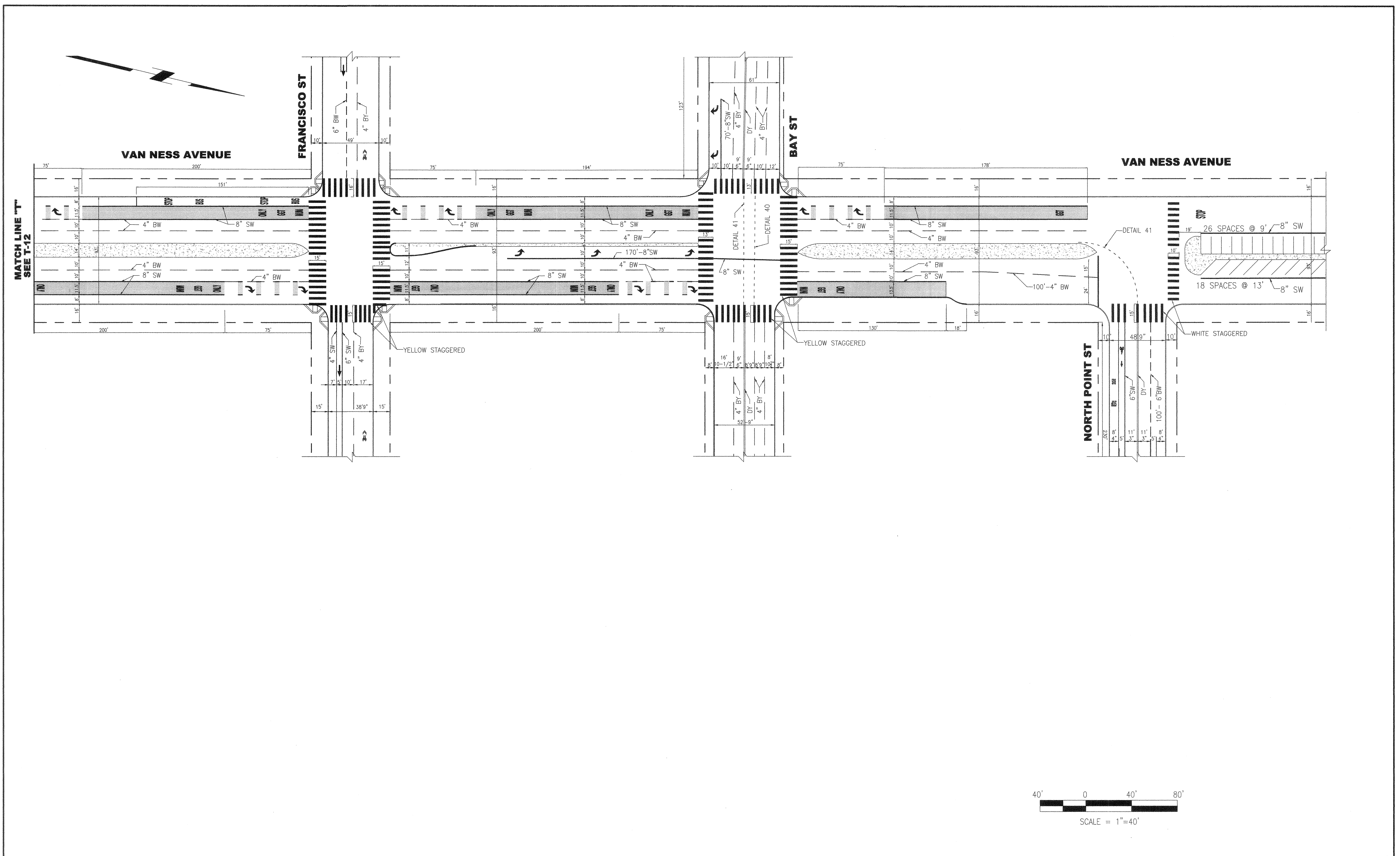

NO.	DATE	DESCRIPTION	REVISED	CHECKED	APPROVED
REVISIONS					

DESIGNED *Romney* 07/31/15
 DRAWN *Romney* 7/31/15
 CHECKED *Cynthia* 7/31/15
 REVIEWED *Romney* 7/31/2015
 RECOMMENDED *Romney*
 APPROVED *Rolaa* 4/24/2015
 DATE **MAY 13 2016**



CITY AND COUNTY OF SAN FRANCISCO
MUNICIPAL TRANSPORTATION AGENCY

APPROVED
[Signature]
 for the DIRECTOR OF TRANSPORTATION

MUNI BUS RAPID TRANSIT SYSTEM		1289
VAN NESS CORRIDOR TRANSIT IMPROVEMENT PROJECT		
FINAL TRAFFIC STRIPING PLAN VAN NESS AVE FROM FRANCISCO TO NORT POINT ST		T-13
		REVISION T-13 0

666