

NO.	DATE	DESCRIPTION	BY	APP.
TABLE OF REVISIONS				

REFERENCE INFORMATION  
& FILE NO. OF SURVEYS



**INFRASTRUCTURE DIVISION**  
DEPARTMENT OF PUBLIC WORKS  
CITY AND COUNTY OF SAN FRANCISCO



DESIGNED: S.YUAN 7/15  
DRAWN: S.YUAN 7/15  
CHECKED: C.YU 7/15

APPROVED: *Mearna McCallen* 7/16  
SECTION MANAGER  
*Paula Davis* 2/3/16  
DEPUTY DIVISION MANAGER  
*Paula Davis* 2/3/16  
DIVISION MANAGER

SCALE: 1" = 5' - 0"  
SHEET OF SHEETS: --- OF ---

MUNI BUS RAPID TRANSIT SYSTEM  
VAN NESS CORRIDOR TRANSIT IMPROVEMENT PROJECT  
ROAD WORK  
BULB & CURB RAMP DETAILS  
TURK ST

CONTRACT NO. 1289  
DRAWING NO. CR-114  
FILE NO. 102,436  
REV. NO. 0

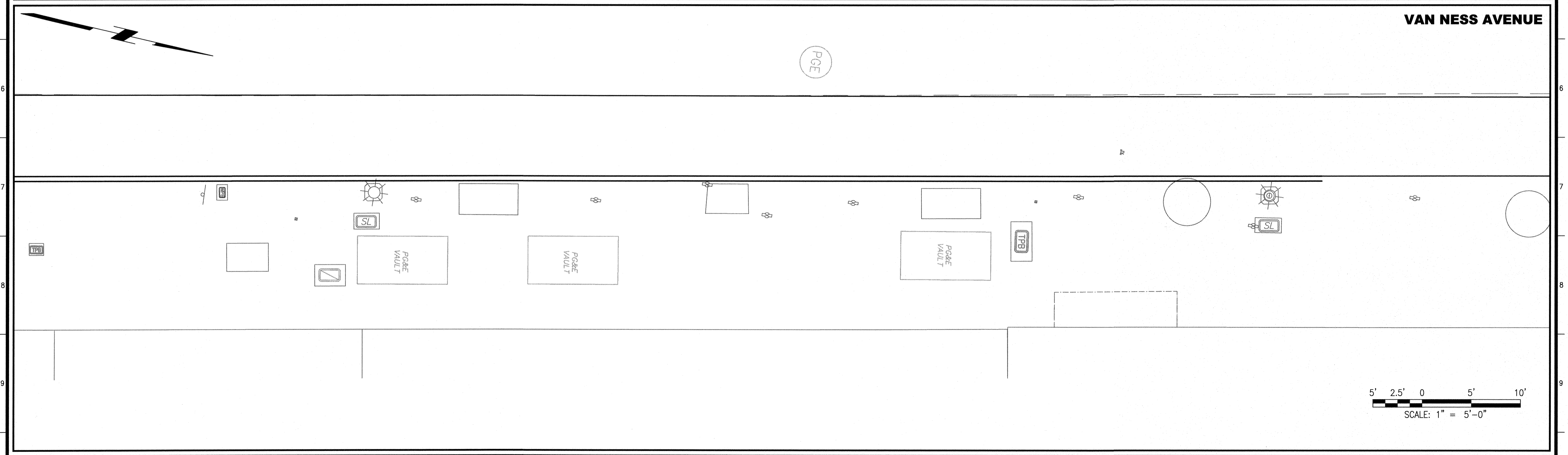
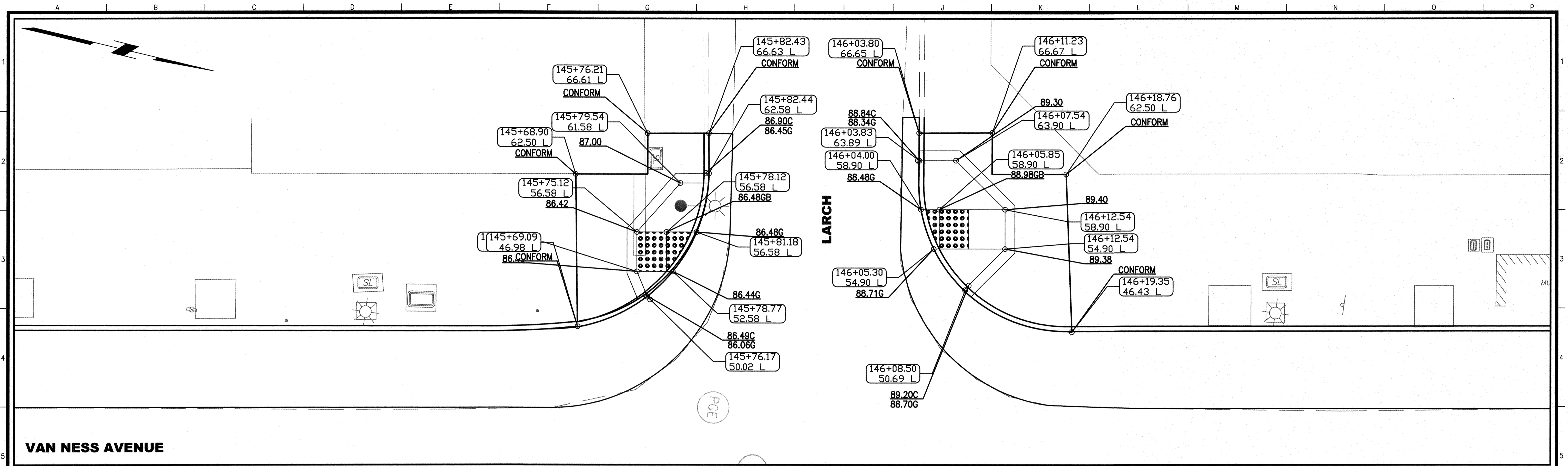

NO.	DATE	DESCRIPTION	BY	APP.
TABLE OF REVISIONS				

REFERENCE INFORMATION  
& FILE NO. OF SURVEYS

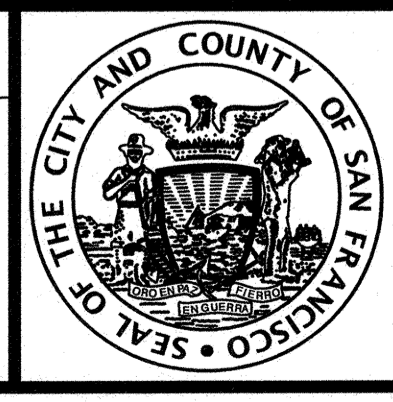

**INFRASTRUCTURE DIVISION**  
DEPARTMENT OF PUBLIC WORKS  
CITY AND COUNTY OF SAN FRANCISCO

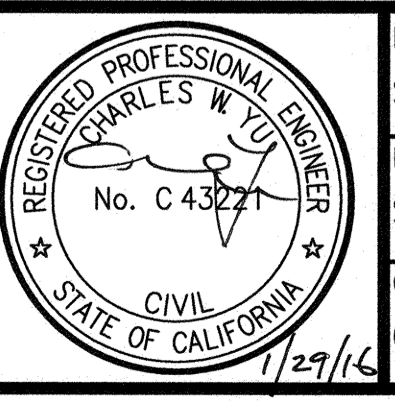

DESIGNED: S.YUAN 7/15  
DRAWN: S.YUAN 7/15  
CHECKED: C.YU 7/15

APPROVED  
SECTION MANAGER: *Meamain Collins* 2/2/16  
DEPUTY DIVISION MANAGER: *Robert Lin* 2/3/16  
DIVISION MANAGER: *Robert Lin* 2/3/16

SCALE: 1" = 5' - 0"  
SHEET OF SHEETS: --- OF ---

MUNI BUS RAPID TRANSIT SYSTEM  
VAN NESS CORRIDOR TRANSIT IMPROVEMENT PROJECT  
ROAD WORK  
BULB & CURB RAMP DETAILS  
LARCH ST

CONTRACT NO. 1289  
DRAWING NO. CR-115  
FILE NO. 102,437  
REV. NO. 0

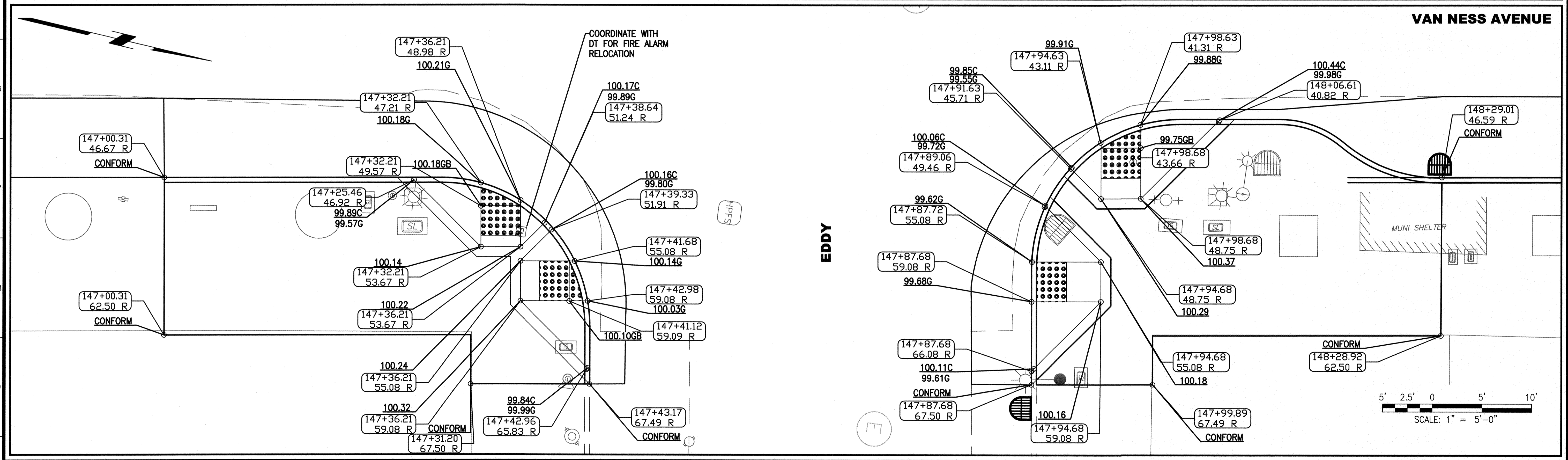
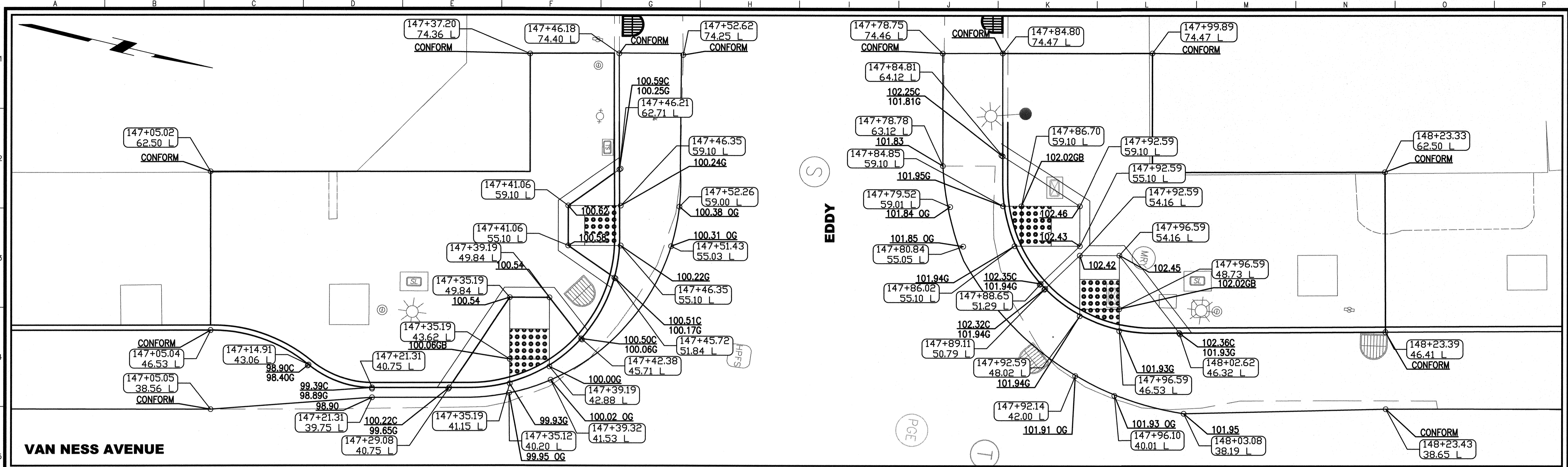

NO.	DATE	DESCRIPTION	BY	APP.
TABLE OF REVISIONS				

REFERENCE INFORMATION  
& FILE NO. OF SURVEYS

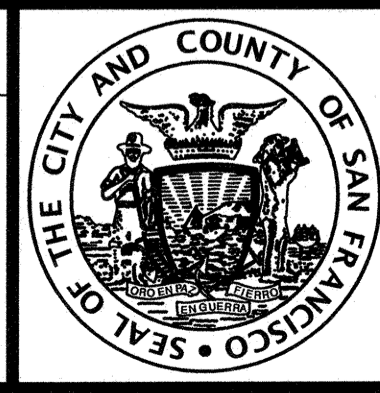

**INFRASTRUCTURE DIVISION**  
DEPARTMENT OF PUBLIC WORKS  
CITY AND COUNTY OF SAN FRANCISCO

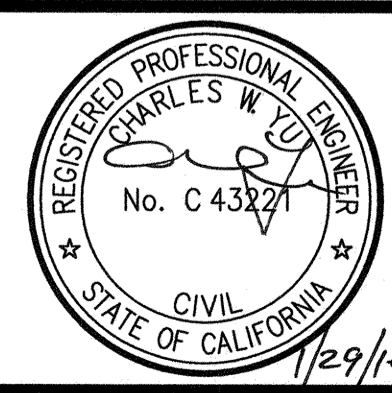

DESIGNED: DATE: 7/15  
DRAWN: DATE: 7/15  
CHECKED: DATE: 7/15

APPROVED: *Charles W. Yuan*  
SECTION MANAGER DATE: 7/15  
*Debra L. Davis*  
DEPUTY DIVISION MANAGER DATE: 7/15  
*Patricia L. Davis*  
DIVISION MANAGER DATE: 7/15

SCALE: 1" = 5'-0"  
SHEET OF SHEETS: --- OF ---

MUNI BUS RAPID TRANSIT SYSTEM  
VAN NESS CORRIDOR TRANSIT IMPROVEMENT PROJECT  
ROAD WORK  
BULB & CURB RAMP DETAILS  
EDDY ST

CONTRACT NO. 1289  
DRAWING NO. CR-116  
FILE NO. 102,438  
REV. NO. 0

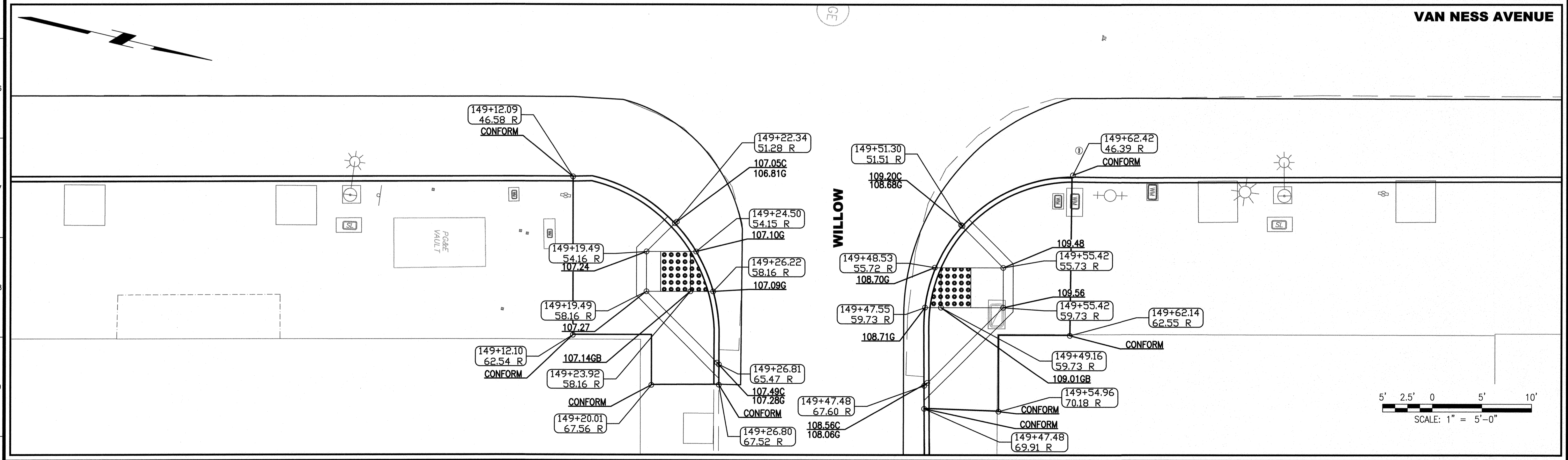
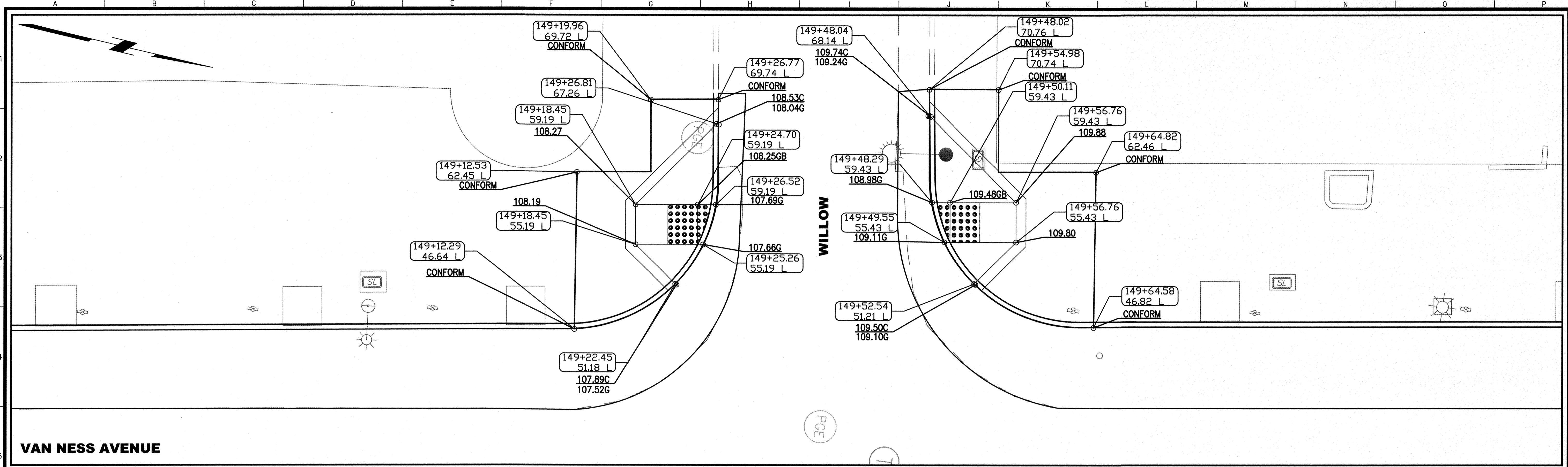

NO.	DATE	DESCRIPTION	BY	APP.
TABLE OF REVISIONS				

REFERENCE INFORMATION  
& FILE NO. OF SURVEYS



**INFRASTRUCTURE DIVISION**  
DEPARTMENT OF PUBLIC WORKS  
CITY AND COUNTY OF SAN FRANCISCO



DESIGNED: S.YUAN 7/15  
DRAWN: S.YUAN 7/15  
CHECKED: C.YU 7/15

APPROVED: *Meama W. Collins* 7/16  
SECTION MANAGER  
*Feb of Liu* 2/16  
DEPUTY DIVISION MANAGER  
*Robert D. Kim* 4/16  
DIVISION MANAGER

SCALE: 1" = 5'-0"  
SHEET OF SHEETS  
--- OF ---

MUNI BUS RAPID TRANSIT SYSTEM  
VAN NESS CORRIDOR TRANSIT IMPROVEMENT PROJECT  
ROAD WORK  
BULB & CURB RAMP DETAILS  
WILLOW ST

CONTRACT NO. 1289  
DRAWING NO. CR-117  
FILE NO. 102,439  
REV. NO. 0

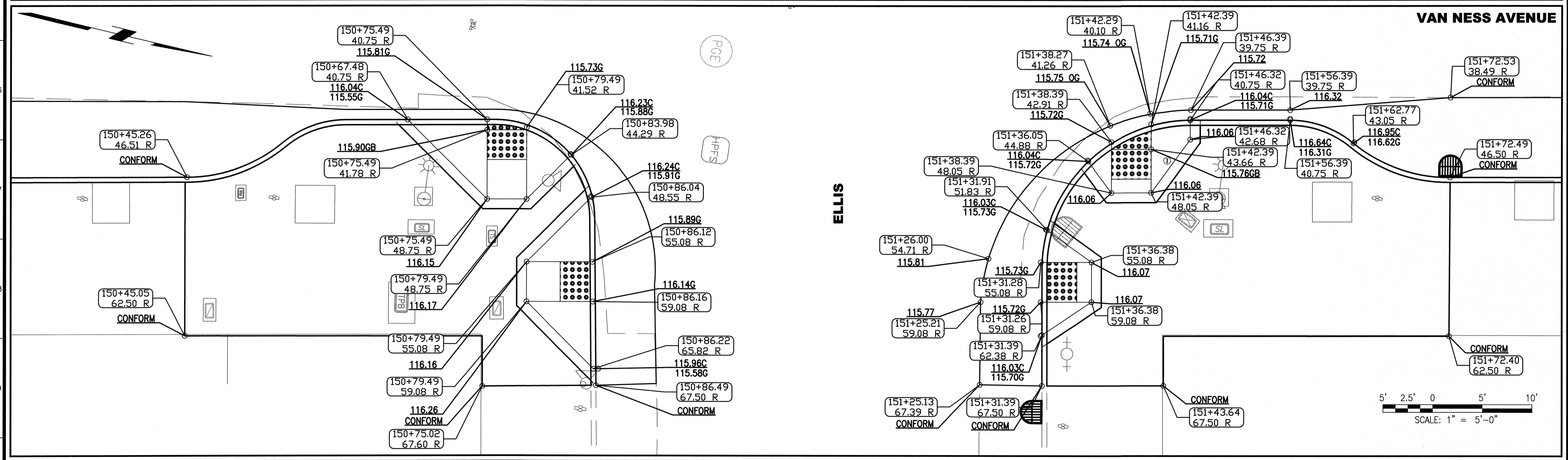
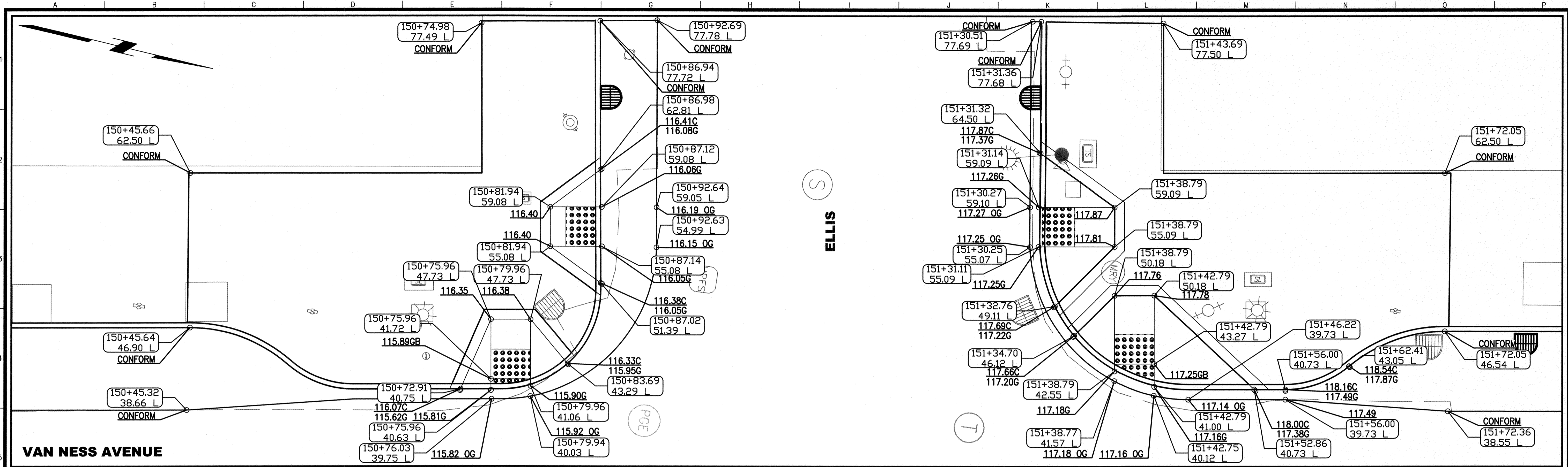

NO.	DATE	DESCRIPTION	BY	APP.
TABLE OF REVISIONS				

REFERENCE INFORMATION  
& FILE NO. OF SURVEYS



**INFRASTRUCTURE DIVISION**  
DEPARTMENT OF PUBLIC WORKS  
CITY AND COUNTY OF SAN FRANCISCO



DESIGNED:	DATE:	APPROVED:	SCALE:
S.YUAN	7/15	<i>Maureen Collins</i> 7/16	1" = 5' - 0"
DRAWN:	DATE:	SECTION MANAGER:	SHEET OF SHEETS
S.YUAN	7/15	<i>Feb &amp; Lisa</i> 2/6/16	--- OF ---
CHECKED:	DATE:	DEPUTY DIVISION MANAGER:	
C.YU	7/15	<i>Paul...</i> 4/16	
		DIVISION MANAGER:	

CONTRACT NO. 1289  
DRAWING NO. CR-118  
FILE NO. 102,440  
REV. NO. 0

MUNI BUS RAPID TRANSIT SYSTEM  
VAN NESS CORRIDOR TRANSIT IMPROVEMENT PROJECT  
BULB & CURB RAMP DETAILS  
ELLIS ST

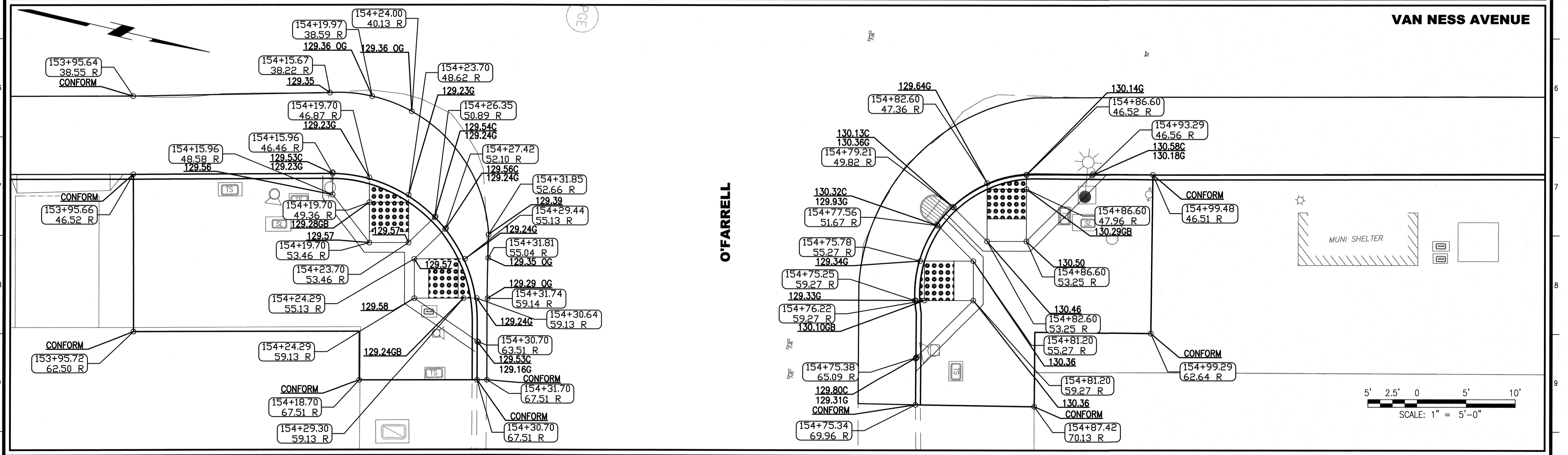
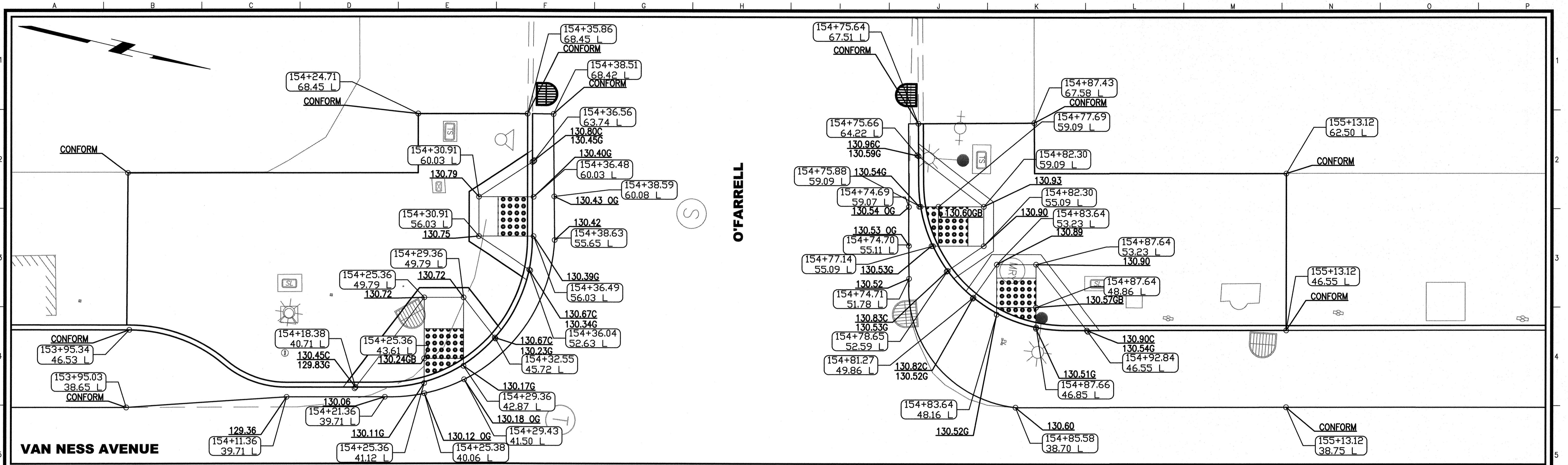

NO.	DATE	DESCRIPTION	BY	APP.
TABLE OF REVISIONS				

REFERENCE INFORMATION & FILE NO. OF SURVEYS	129.24GB
---	----------

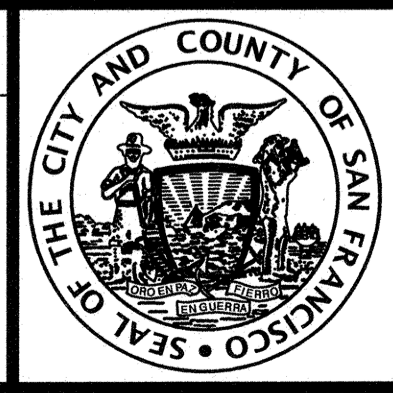

**INFRASTRUCTURE DIVISION**  
 DEPARTMENT OF PUBLIC WORKS  
 CITY AND COUNTY OF SAN FRANCISCO

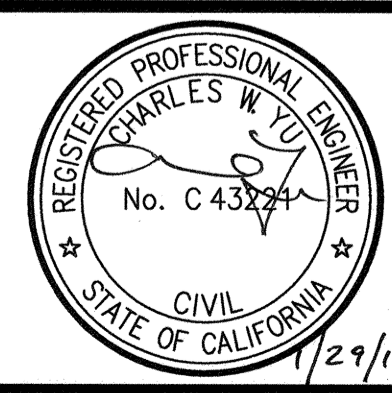

DESIGNED:	S.YUAN	DATE:	7/15
DRAWN:	S.YUAN	DATE:	7/15
CHECKED:	C.YU	DATE:	7/15

APPROVED:	<i>Manman Cullen</i>	DATE:	7/15
SECTION MANAGER:	<i>Feb Lin</i>	DATE:	7/15
DEPUTY DIVISION MANAGER:	<i>Paul Lin</i>	DATE:	7/15
DIVISION MANAGER:		DATE:	

SCALE:	1" = 5' - 0"
SHEET OF SHEETS	--- OF ---

**MUNI BUS RAPID TRANSIT SYSTEM**  
**VAN NESS CORRIDOR TRANSIT IMPROVEMENT PROJECT**  
**ROAD WORK**  
**BULB & CURB RAMP DETAILS**  
**O'FARRELL ST**

CONTRACT NO.	1289
DRAWING NO.	CR-119
FILE NO.	102,441
REV. NO.	0

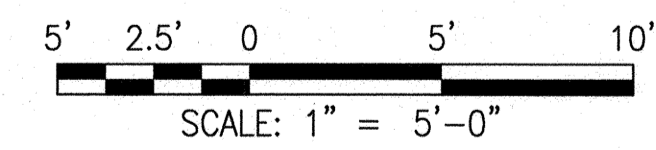
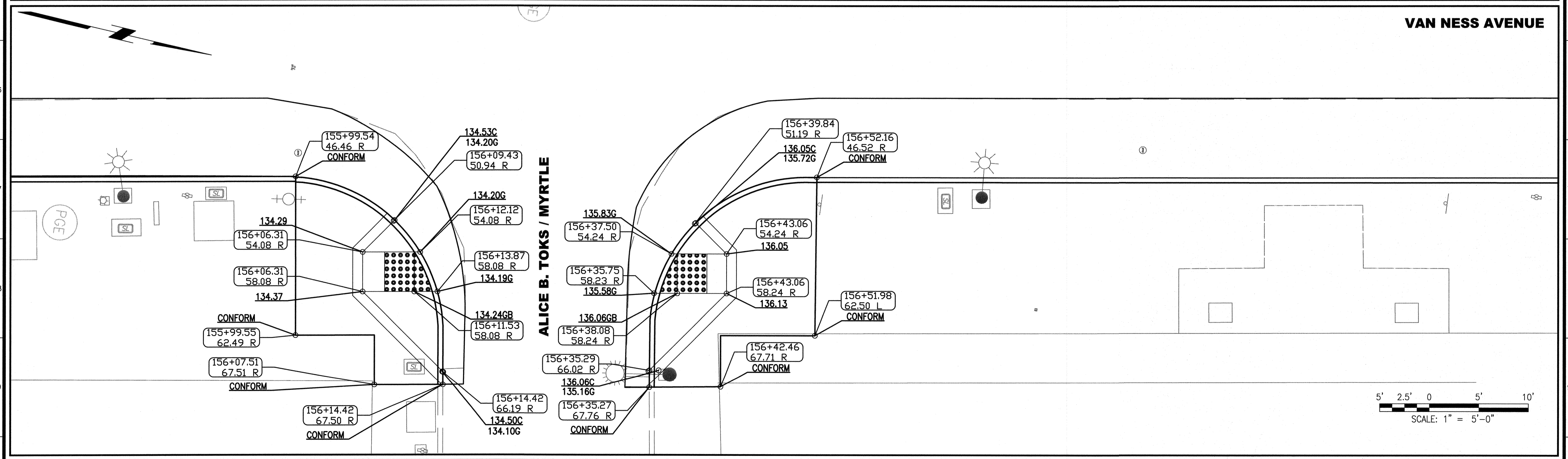
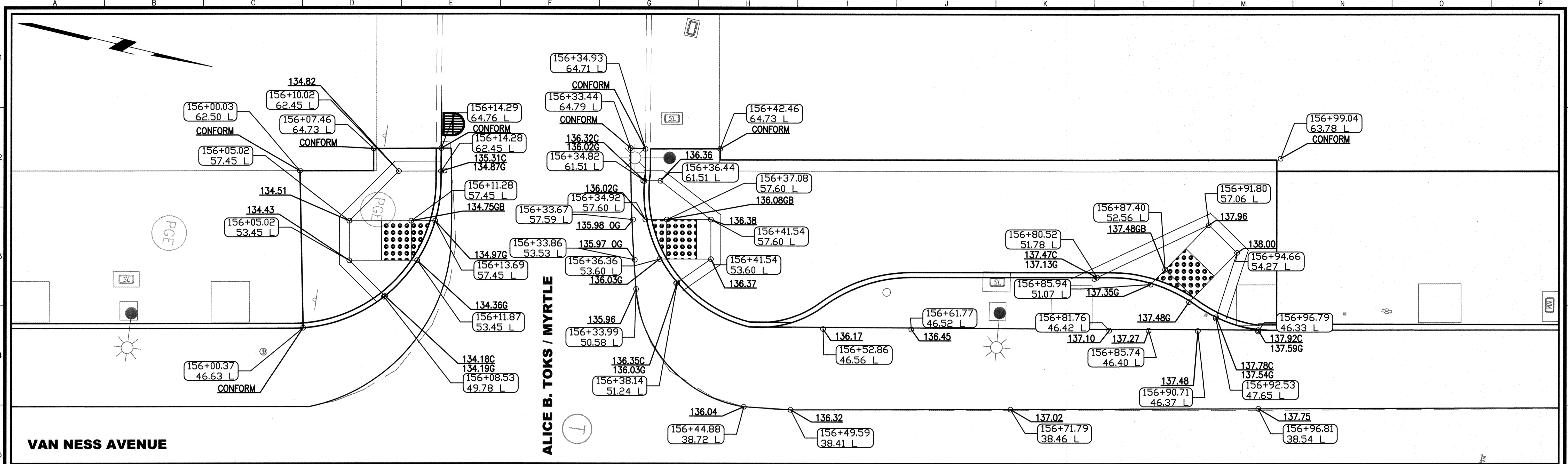

NO.	DATE	DESCRIPTION	BY	APP.
TABLE OF REVISIONS				

REFERENCE INFORMATION & FILE NO. OF SURVEYS

**INFRASTRUCTURE DIVISION**  
 DEPARTMENT OF PUBLIC WORKS  
 CITY AND COUNTY OF SAN FRANCISCO



 REGISTERED PROFESSIONAL ENGINEER  
 CHARLES W. YU  
 No. C43727  
 CIVIL  
 STATE OF CALIFORNIA  
 7/29/16

DESIGNED:	DATE:	APPROVED:
S.YUAN	7/15	<i>Manana Colten</i> 7/16
DRAWN:	DATE:	SECTION MANAGER
S.YUAN	7/15	<i>John Lin</i> 2/3/16
CHECKED:	DATE:	DEPUTY DIVISION MANAGER
C.YU	7/15	<i>Richard Wu</i> 4/3/16
		DIVISION MANAGER

SCALE:	1" = 5' - 0"
SHEET OF SHEETS	--- OF ---

**MUNI BUS RAPID TRANSIT SYSTEM**  
**VAN NESS CORRIDOR TRANSIT IMPROVEMENT PROJECT**  
**ROAD WORK**  
**BULB & CURB RAMP DETAILS**  
**ALICE B TOKLAS AND MYRTLE ST**

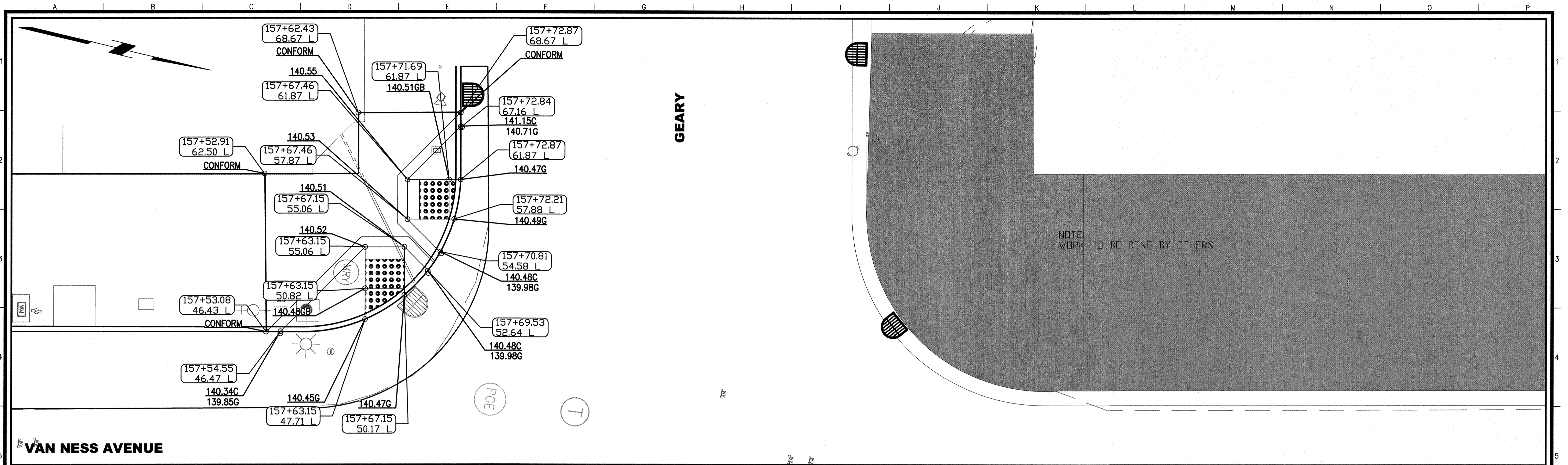
CONTRACT NO.	1289
DRAWING NO.	CR-120
FILE NO.	102,442
REV. NO.	0



REFERENCE INFORMATION & FILE NO. OF SURVEYS

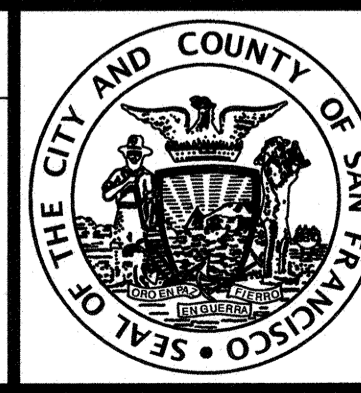

**INFRASTRUCTURE DIVISION**  
 DEPARTMENT OF PUBLIC WORKS  
 CITY AND COUNTY OF SAN FRANCISCO

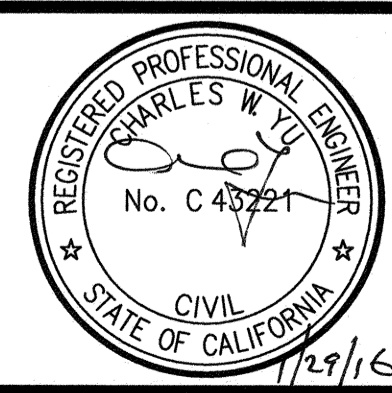

DESIGNED: S.YUAN 7/15  
 DRAWN: S.YUAN 7/15  
 CHECKED: C.YU 7/15

APPROVED: *Meamora Callan* 7/16  
 SECTION MANAGER  
*Paul J. Chin* 2/3/16  
 DEPUTY DIVISION MANAGER  
*Paul J. Chin* 2/3/16  
 DIVISION MANAGER

SCALE: 1" = 5' - 0"

SHEET OF SHEETS  
 --- OF ---

MUNI BUS RAPID TRANSIT SYSTEM  
 VAN NESS CORRIDOR TRANSIT IMPROVEMENT PROJECT

ROAD WORK  
 BULB & CURB RAMP DETAILS  
 GEARY BLVD

CONTRACT NO. 1289  
 DRAWING NO. CR-121  
 FILE NO. 102,443  
 REV. NO. 0



NOTE:  
WORK TO BE DONE BY OTHERS

VAN NESS AVENUE

VAN NESS AVENUE

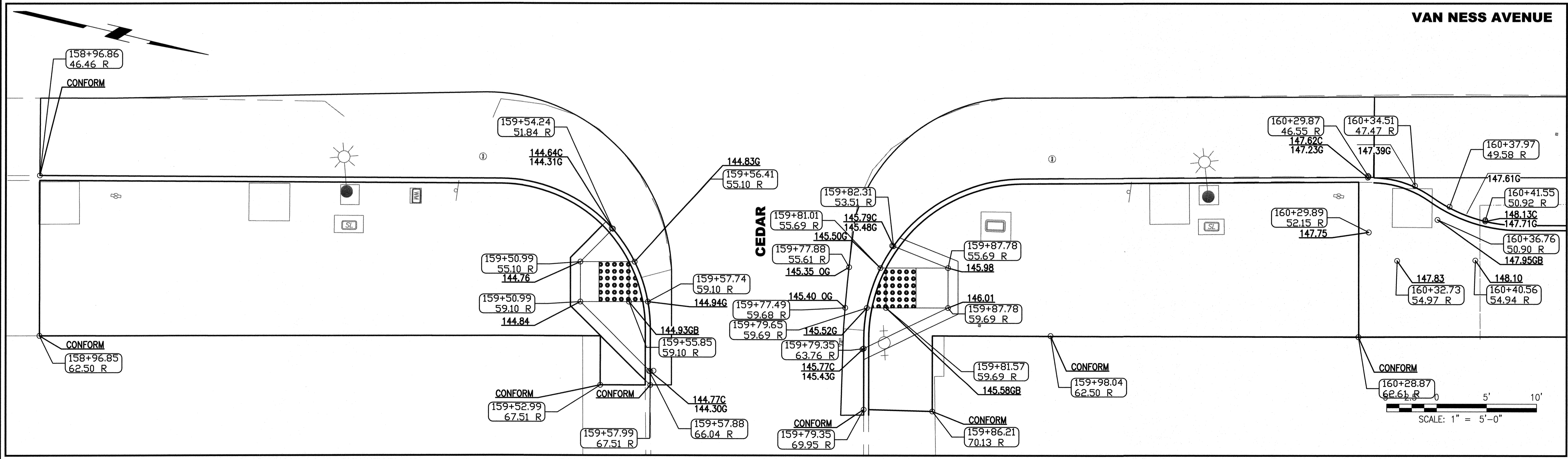

NO.	DATE	DESCRIPTION	BY	APP.
TABLE OF REVISIONS				

REFERENCE INFORMATION  
& FILE NO. OF SURVEYS



**INFRASTRUCTURE DIVISION**  
DEPARTMENT OF PUBLIC WORKS  
CITY AND COUNTY OF SAN FRANCISCO



DESIGNED:	DATE:	APPROVED:	DATE:
S.YUAN	7/15	<i>Charles W. Yu</i>	7/15
DRAWN:	DATE:	SECTION MANAGER:	DATE:
S.YUAN	7/15	<i>Paul L. Davis</i>	7/15
CHECKED:	DATE:	DEPUTY DIVISION MANAGER:	DATE:
C.YU	7/15	<i>Paul L. Davis</i>	7/15
		DIVISION MANAGER:	DATE:

SCALE:  
1" = 5'-0"  
SHEET OF SHEETS  
--- OF ---

MUNI BUS RAPID TRANSIT SYSTEM  
VAN NESS CORRIDOR TRANSIT IMPROVEMENT PROJECT  
**ROAD WORK  
BULB & CURB RAMP DETAILS  
CEDAR ST**

CONTRACT NO.  
1289  
DRAWING NO.  
CR-122  
FILE NO.  
102,444  
REV. NO.  
0



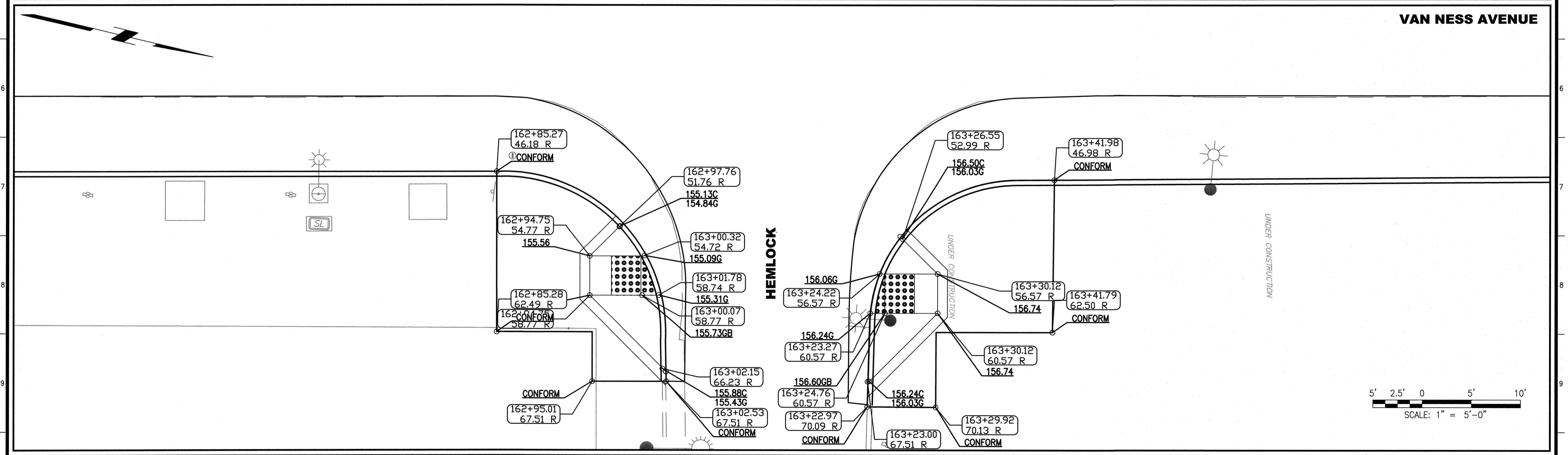
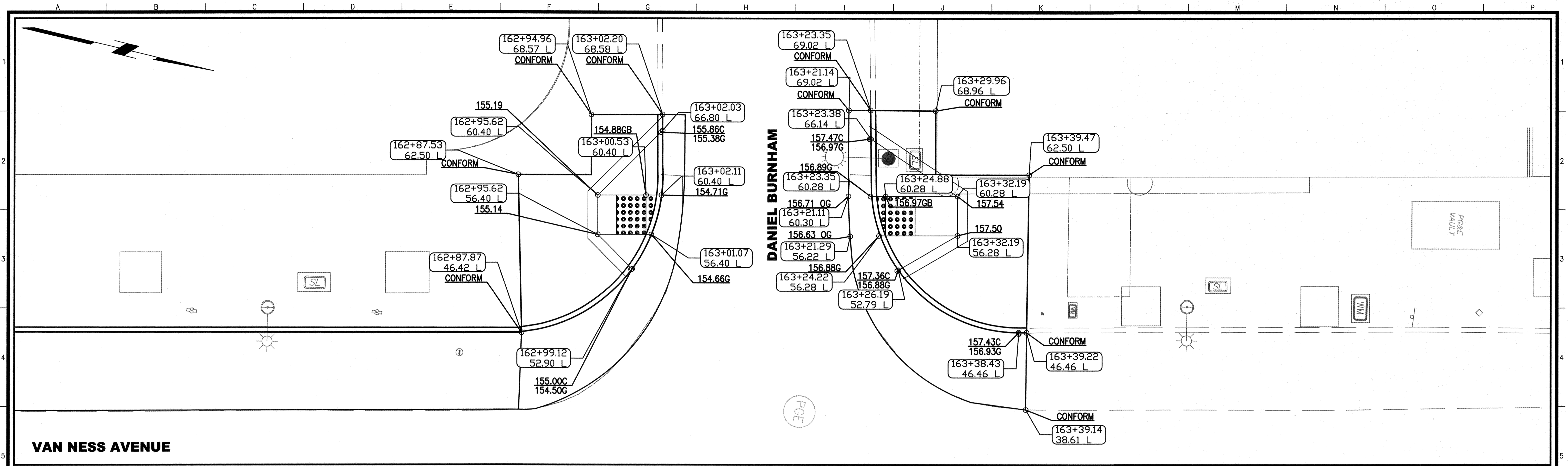

NO.	DATE	DESCRIPTION	BY	APP.
TABLE OF REVISIONS				

REFERENCE INFORMATION  
& FILE NO. OF SURVEYS

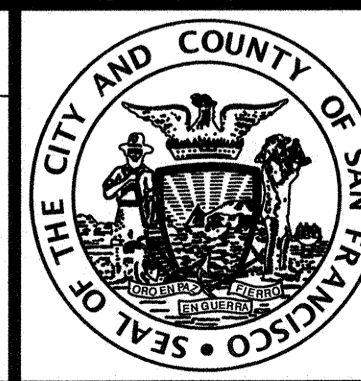

**INFRASTRUCTURE DIVISION**  
DEPARTMENT OF PUBLIC WORKS  
CITY AND COUNTY OF SAN FRANCISCO

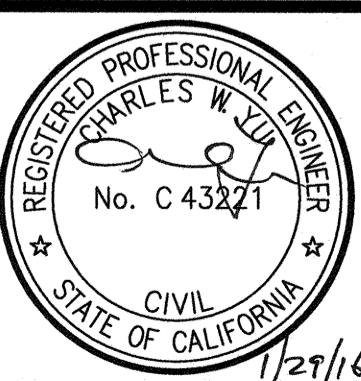

DESIGNED: S.YUAN 7/15  
DRAWN: S.YUAN 7/15  
CHECKED: C.YU 7/15

APPROVED: *Alanna Callen* 7/16  
SECTION MANAGER  
*John Kim* 2/3/16  
DEPUTY DIVISION MANAGER  
*Paul S. Diaz* 2/3/16  
DIVISION MANAGER

SCALE: 1" = 5'-0"  
SHEET OF SHEETS  
--- OF ---

MUNI BUS RAPID TRANSIT SYSTEM  
VAN NESS CORRIDOR TRANSIT IMPROVEMENT PROJECT  
ROAD WORK  
BULB & CURB RAMP DETAILS  
HEMLOCK ST AND DANIEL BURNHAM CT

CONTRACT NO. 1289  
DRAWING NO. CR-124  
FILE NO. 102,446  
REV. NO. 0

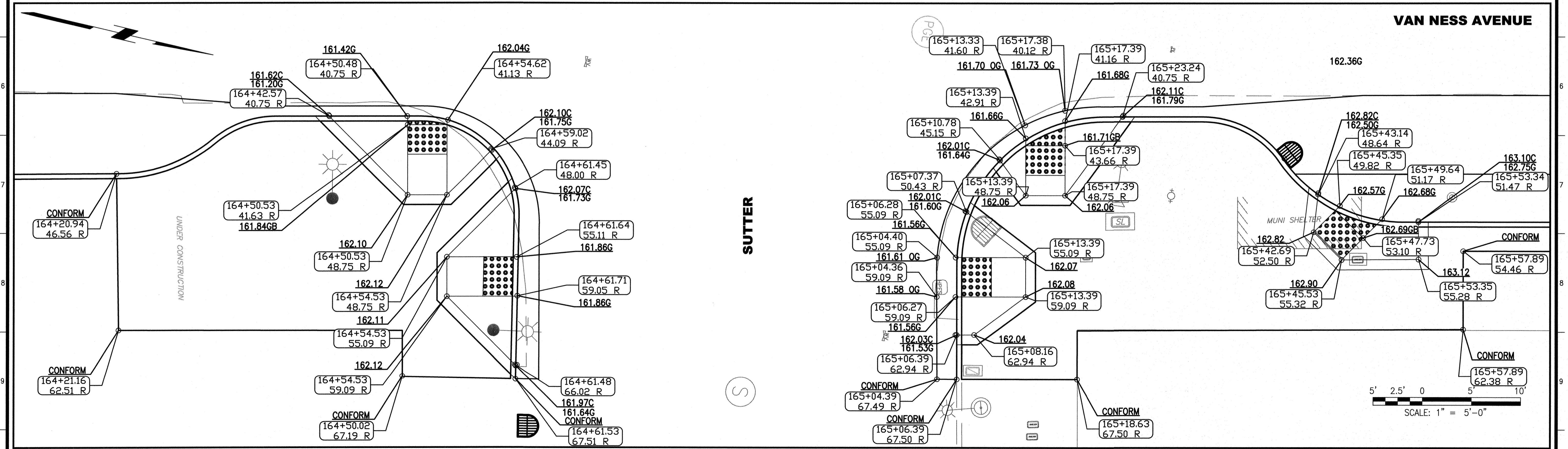
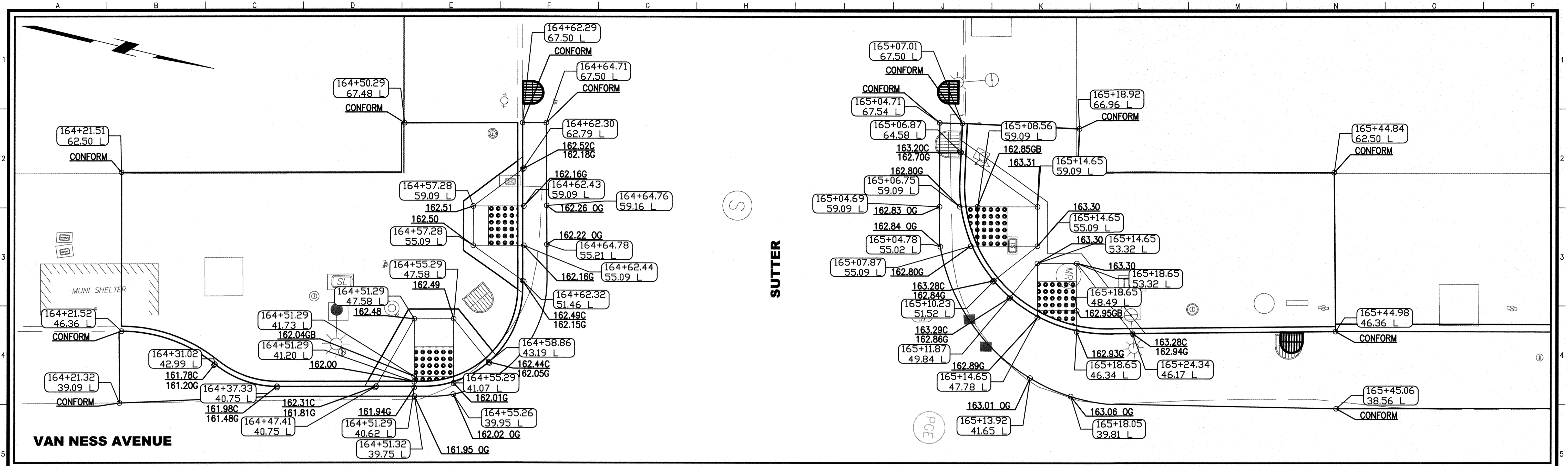

NO.	DATE	DESCRIPTION	BY	APP.
TABLE OF REVISIONS				

REFERENCE INFORMATION & FILE NO. OF SURVEYS

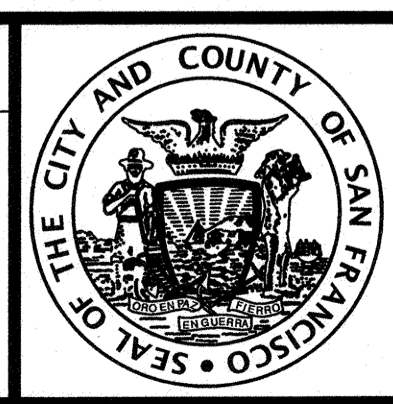

**INFRASTRUCTURE DIVISION**  
 DEPARTMENT OF PUBLIC WORKS  
 CITY AND COUNTY OF SAN FRANCISCO

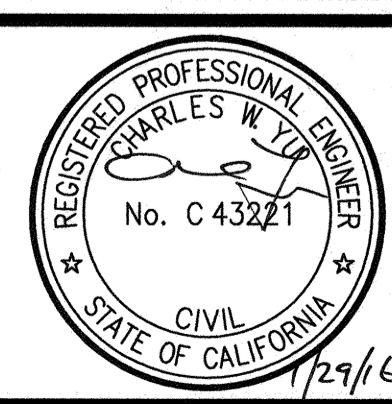

DESIGNED: S.YUAN 7/15  
 DRAWN: S.YUAN 7/15  
 CHECKED: C.YU 7/15

APPROVED: *[Signature]* 7/16  
 SECTION MANAGER  
*[Signature]* 2/16  
 DEPUTY DIVISION MANAGER  
*[Signature]* 2/16  
 DIVISION MANAGER

SCALE: 1" = 5' - 0"

SHEET OF SHEETS  
 --- OF ---

MUNI BUS RAPID TRANSIT SYSTEM  
 VAN NESS CORRIDOR TRANSIT IMPROVEMENT PROJECT

ROAD WORK  
 BULB & CURB RAMP DETAILS  
 SUTTER ST

CONTRACT NO. 1289  
 DRAWING NO. CR-125  
 FILE NO. 102.447  
 REV. NO. 0

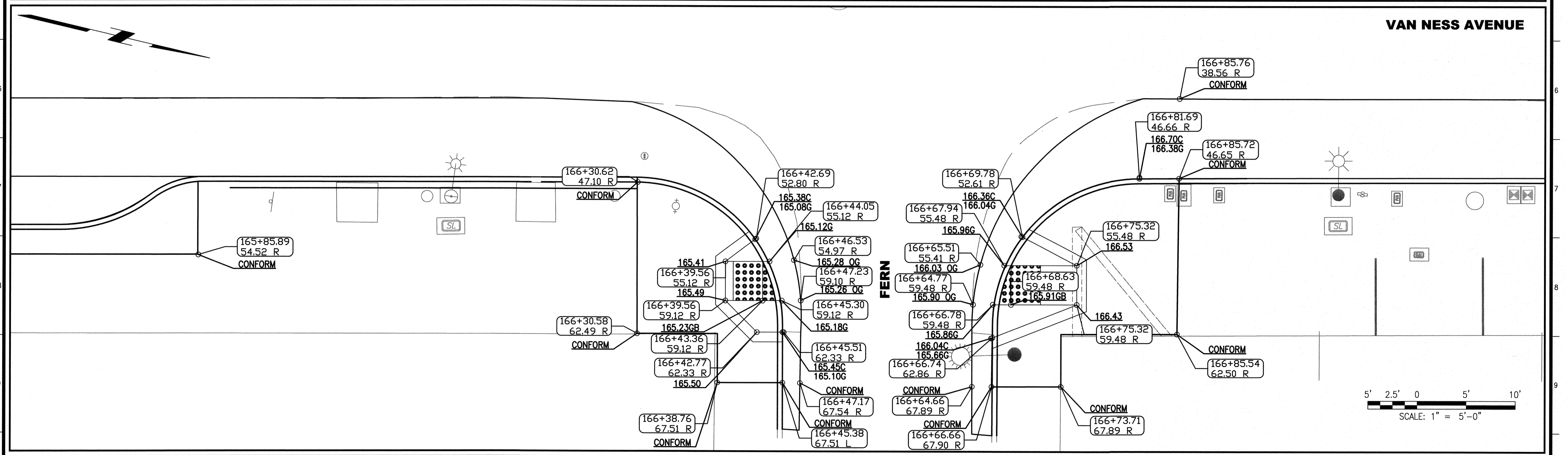
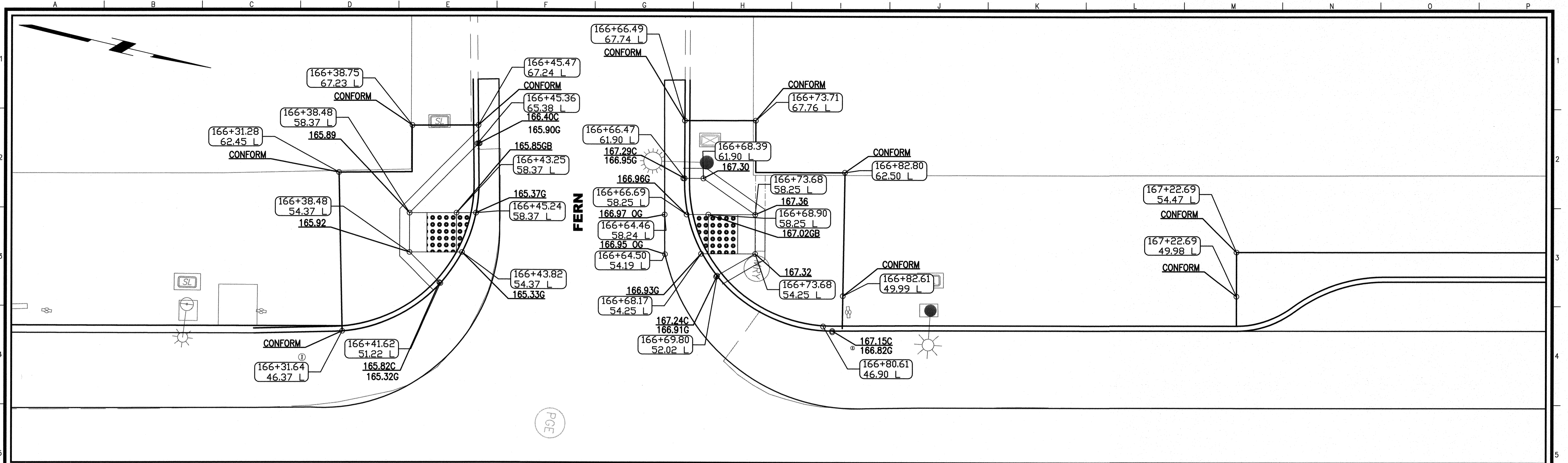

NO.	DATE	DESCRIPTION	BY	APP.
TABLE OF REVISIONS				

REFERENCE INFORMATION  
& FILE NO. OF SURVEYS

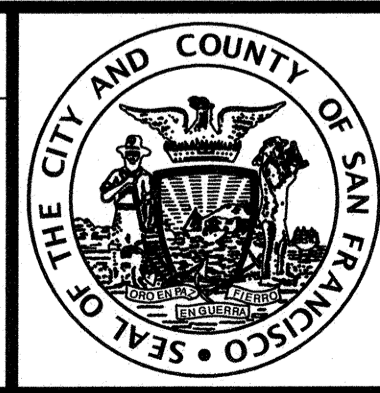

**INFRASTRUCTURE DIVISION**  
DEPARTMENT OF PUBLIC WORKS  
CITY AND COUNTY OF SAN FRANCISCO



DESIGNED:	DATE:	APPROVED:	SCALE:
S.YUAN	7/15	<i>Maryann Callan</i> 7/16	1" = 5' - 0"
DRAWN:	DATE:	SECTION MANAGER:	DATE:
S.YUAN	7/15	<i>Frank L. Lewis</i> 2/1/16	
CHECKED:	DATE:	DEPUTY DIVISION MANAGER:	DATE:
C.YU	7/15	<i>Colin D. Wier</i> 2/1/16	
		DIVISION MANAGER:	DATE:

SHEET OF SHEETS  
--- OF ---

MUNI BUS RAPID TRANSIT SYSTEM  
VAN NESS CORRIDOR TRANSIT IMPROVEMENT PROJECT  
ROAD WORK  
BULB & CURB RAMP DETAILS  
FERN ST

CONTRACT NO. 1289  
DRAWING NO. CR-126  
FILE NO. 102,448  
REV. NO. 0

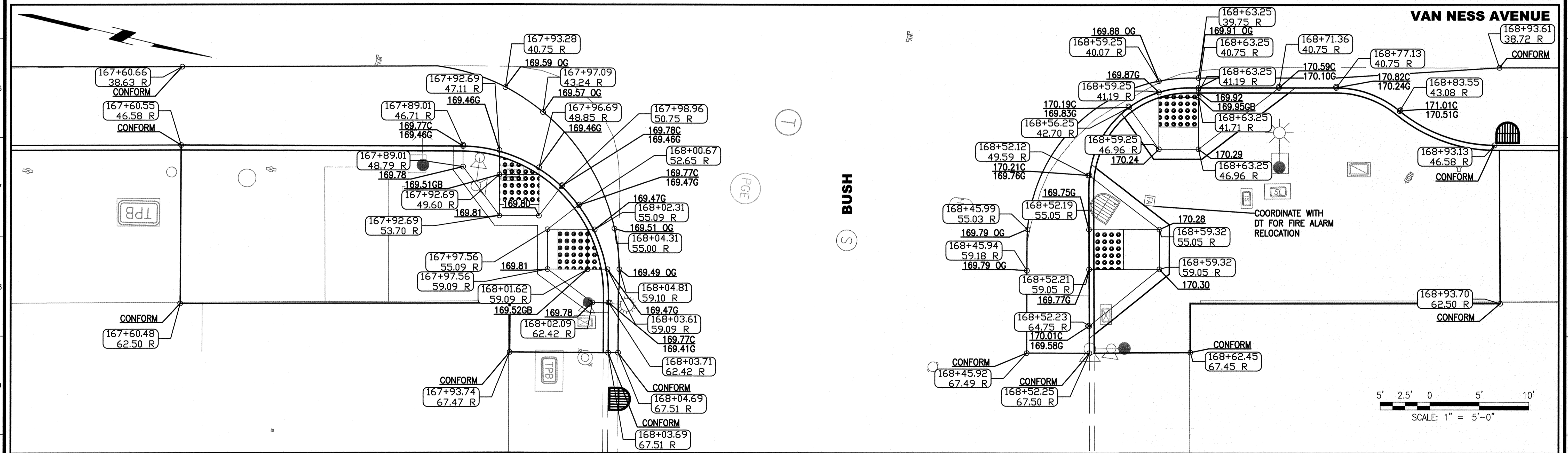
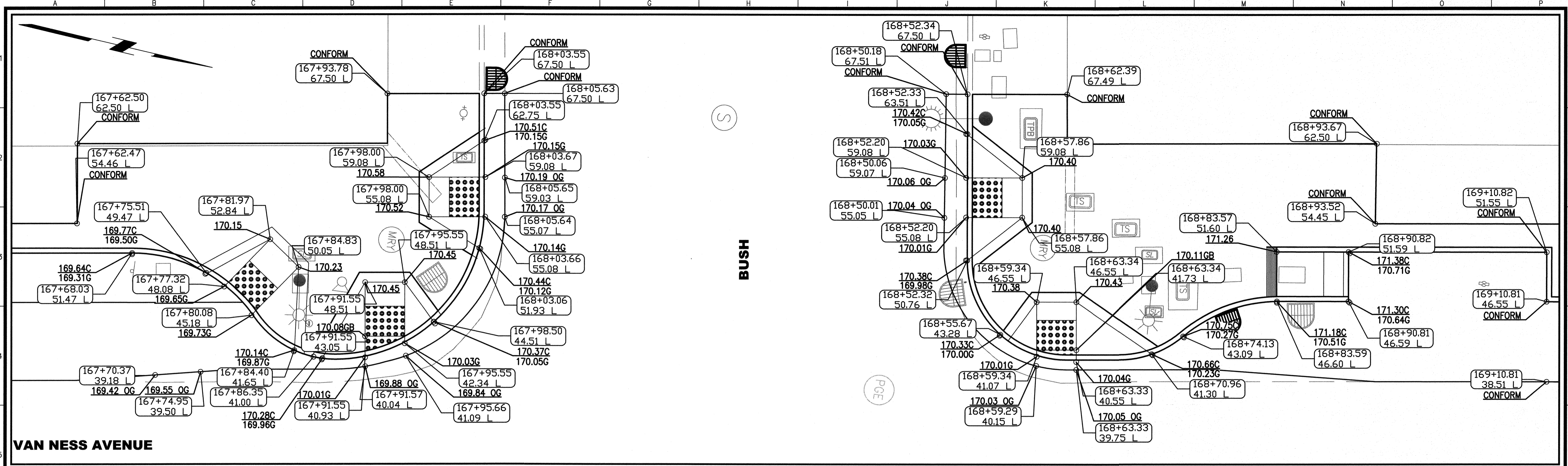

NO.	DATE	DESCRIPTION	BY	APP.
TABLE OF REVISIONS				

REFERENCE INFORMATION  
& FILE NO. OF SURVEYS



**INFRASTRUCTURE DIVISION**  
DEPARTMENT OF PUBLIC WORKS  
CITY AND COUNTY OF SAN FRANCISCO



DESIGNED:	DATE:	APPROVED:	DATE:
S.YUAN	7/15	<i>Charles W. Yu</i>	7/16
DRAWN:	DATE:	SECTION MANAGER:	DATE:
S.YUAN	7/15	<i>Charles W. Yu</i>	7/16
CHECKED:	DATE:	DEPUTY DIVISION MANAGER:	DATE:
C.YU	7/15	<i>Charles W. Yu</i>	7/16
		DIVISION MANAGER:	DATE:

SCALE:	1" = 5' - 0"
SHEET OF SHEETS	--- OF ---

MUNI BUS RAPID TRANSIT SYSTEM  
VAN NESS CORRIDOR TRANSIT IMPROVEMENT PROJECT  
ROAD WORK  
BULB & CURB RAMP DETAILS  
BUSH ST

CONTRACT NO.	1289
DRAWING NO.	CR-127
FILE NO.	102,449
REV. NO.	0







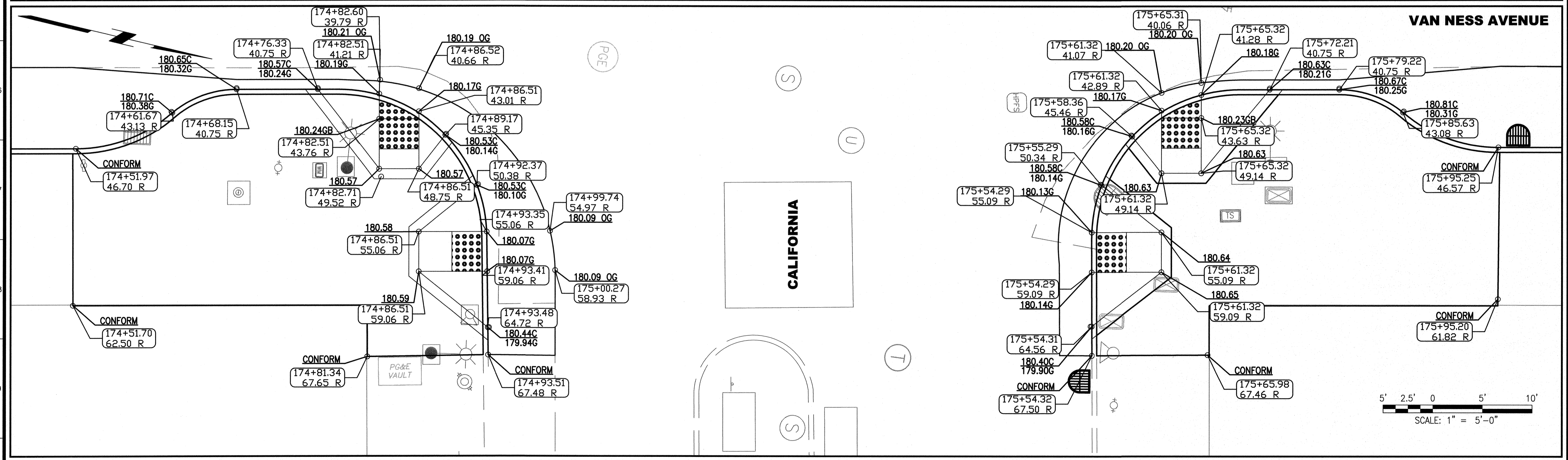
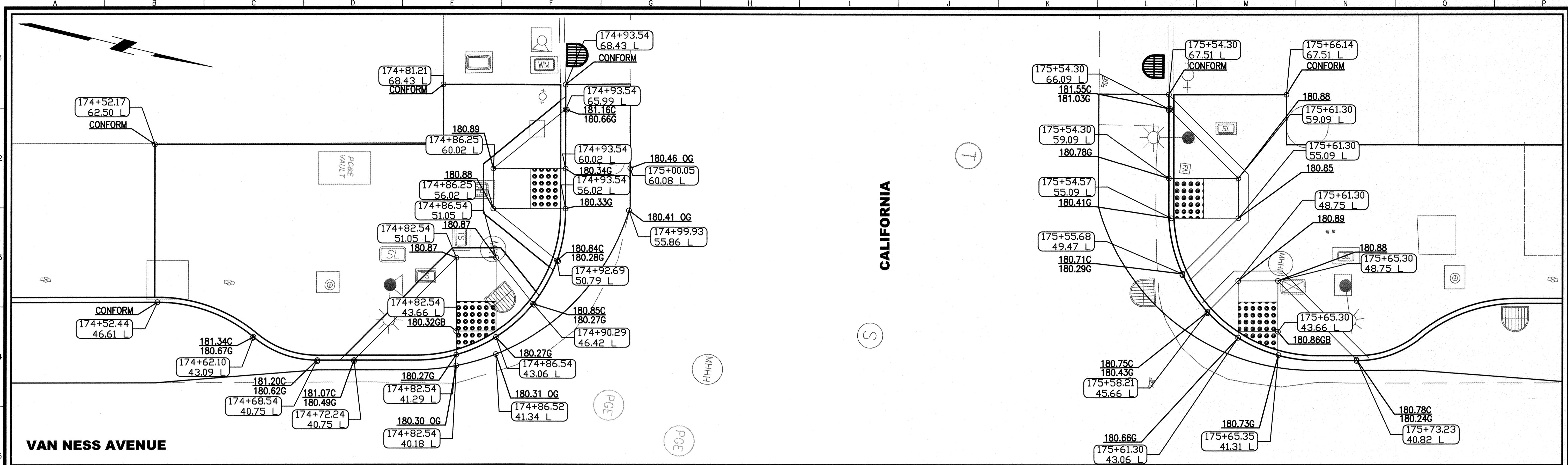

NO.	DATE	DESCRIPTION	BY	APP.
TABLE OF REVISIONS				

REFERENCE INFORMATION & FILE NO. OF SURVEYS



**INFRASTRUCTURE DIVISION**  
 DEPARTMENT OF PUBLIC WORKS  
 CITY AND COUNTY OF SAN FRANCISCO



 REGISTERED PROFESSIONAL ENGINEER  
 CHARLES W. YU  
 No. C 43227  
 CIVIL  
 STATE OF CALIFORNIA

DESIGNED:	DATE:	APPROVED:	SCALE:
S.YUAN	7/15	<i>Meannor Collins</i> 7/16 SECTION MANAGER	1" = 5' - 0"
DRAWN:	DATE:	<i>John Davis</i> 2/16 DEPUTY DIVISION MANAGER	SHEET OF SHEETS
S.YUAN	7/15	<i>Paul M. Kim</i> 4/16 DIVISION MANAGER	--- OF ---
CHECKED:	DATE:		
C.YU	7/15		

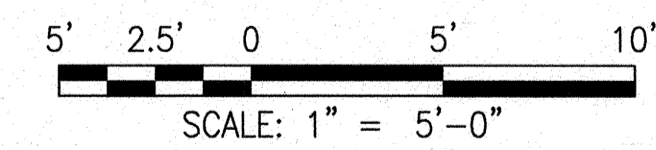
**MUNI BUS RAPID TRANSIT SYSTEM**  
**VAN NESS CORRIDOR TRANSIT IMPROVEMENT PROJECT**  
**ROAD WORK**  
**BULB & CURB RAMP DETAILS**  
**CALIFORNIA ST**

CONTRACT NO.	DRAWING NO.	FILE NO.	REV. NO.
1289	CR-130	102,452	0

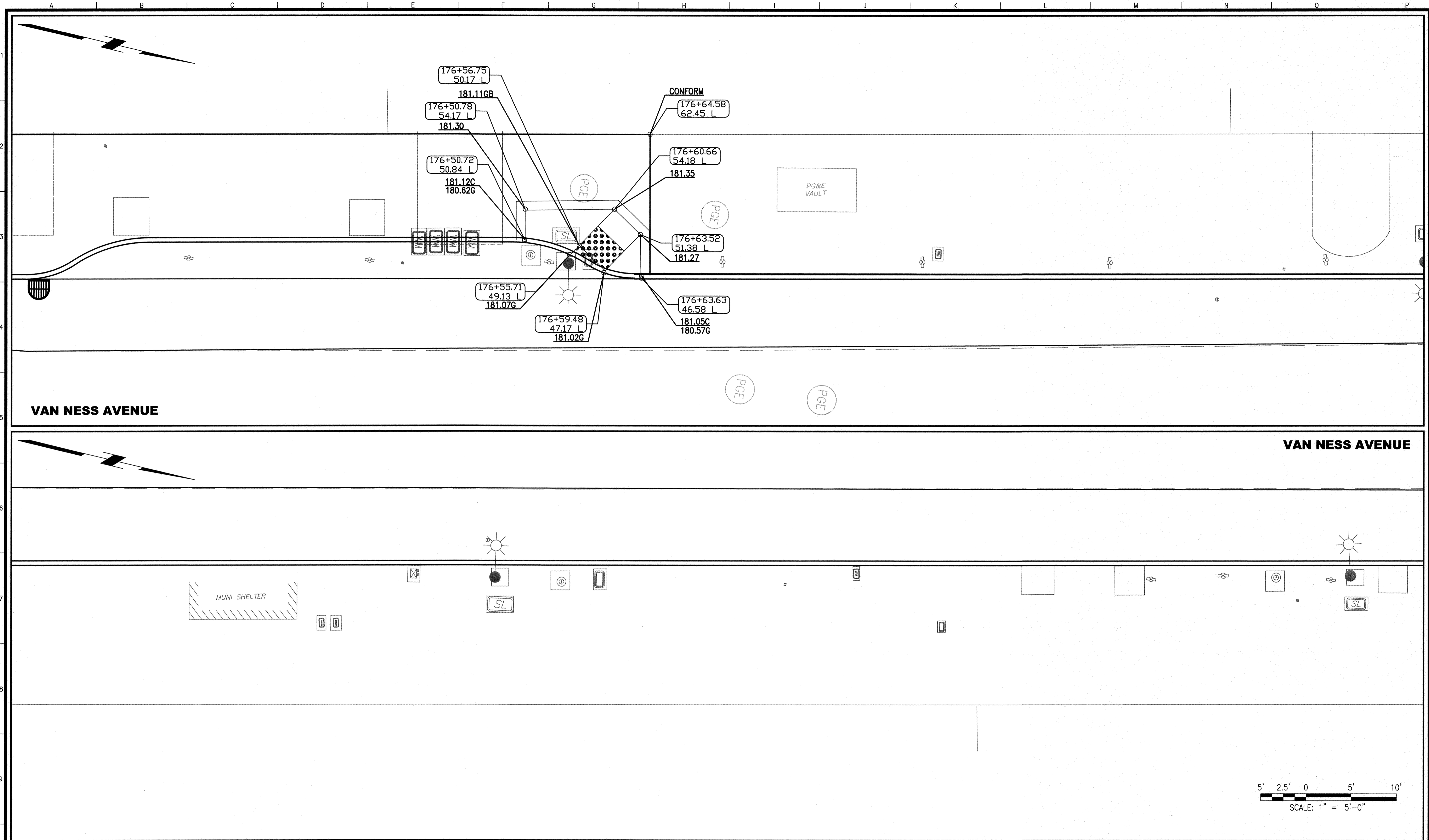



NO.	DATE	DESCRIPTION	BY	APP.
TABLE OF REVISIONS				

REFERENCE INFORMATION  
& FILE NO. OF SURVEYS

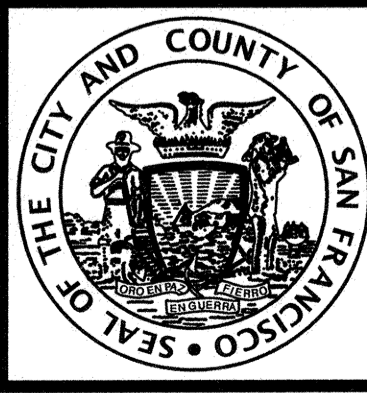

**INFRASTRUCTURE DIVISION**  
DEPARTMENT OF PUBLIC WORKS  
CITY AND COUNTY OF SAN FRANCISCO



DESIGNED: S.YUAN 7/15  
DRAWN: S.YUAN 7/15  
CHECKED: C.YU 7/15

APPROVED  
SECTION MANAGER: *Meannan Collier* 7/16  
DEPUTY DIVISION MANAGER: *John P. Davis* 2/3/16  
DIVISION MANAGER: *Paul D. Davis* 2/3/16

SCALE: 1" = 5'-0"  
SHEET OF SHEETS: --- OF ---

MUNI BUS RAPID TRANSIT SYSTEM  
VAN NESS CORRIDOR TRANSIT IMPROVEMENT PROJECT  
ROAD WORK  
BULB & CURB RAMP DETAILS  
BETWEEN CALIFORNIA ST AND SACRAMENTO ST

CONTRACT NO. 1289  
DRAWING NO. CR-131  
FILE NO. 102,453  
REV. NO. 0

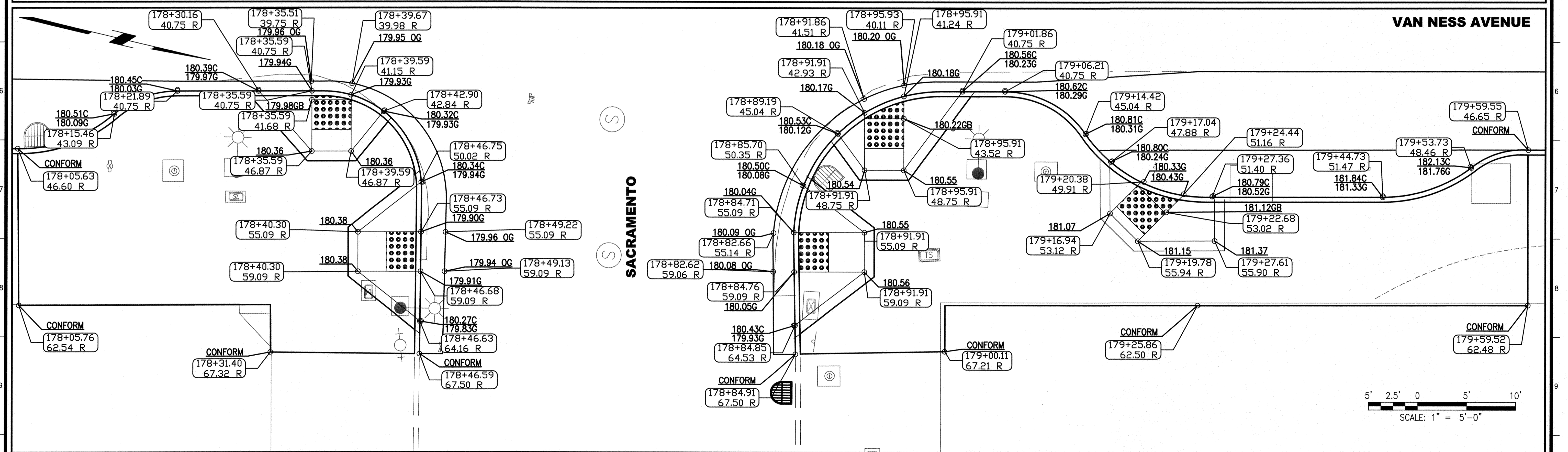
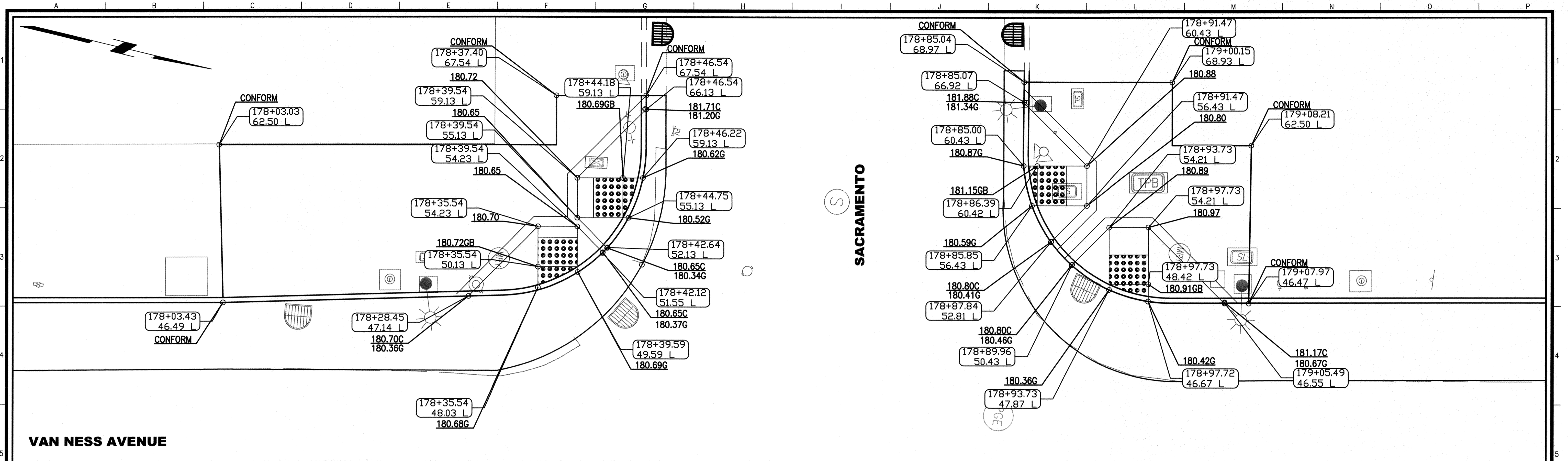

NO.	DATE	DESCRIPTION	BY	APP.
TABLE OF REVISIONS				

REFERENCE INFORMATION  
& FILE NO. OF SURVEYS

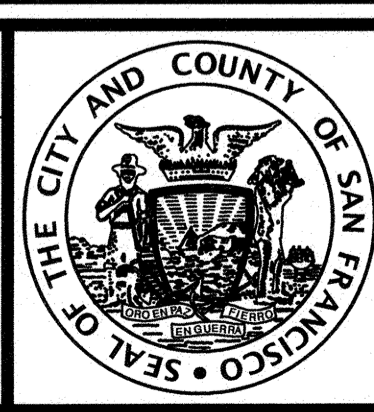

**INFRASTRUCTURE DIVISION**  
DEPARTMENT OF PUBLIC WORKS  
CITY AND COUNTY OF SAN FRANCISCO

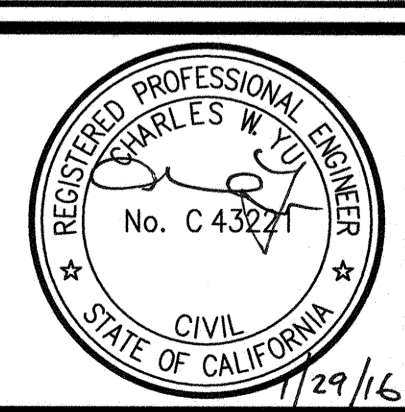

DESIGNED:	DATE:	APPROVED:	SCALE:
S.YUAN	7/15	<i>Charles W. Yu</i>	1" = 5' - 0"
DRAWN:	DATE:	SECTION MANAGER:	SHEET OF SHEETS
S.YUAN	7/15	<i>Charles W. Yu</i>	--- OF ---
CHECKED:	DATE:	DEPUTY DIVISION MANAGER:	
C.YU	7/15	<i>Charles W. Yu</i>	
		DIVISION MANAGER:	

CONTRACT NO. 1289  
DRAWING NO. CR-132  
FILE NO. 102,452  
REV. NO. 0

MUNI BUS RAPID TRANSIT SYSTEM  
VAN NESS CORRIDOR TRANSIT IMPROVEMENT PROJECT  
ROAD WORK  
BULB & CURB RAMP DETAILS  
SACRAMENTO ST

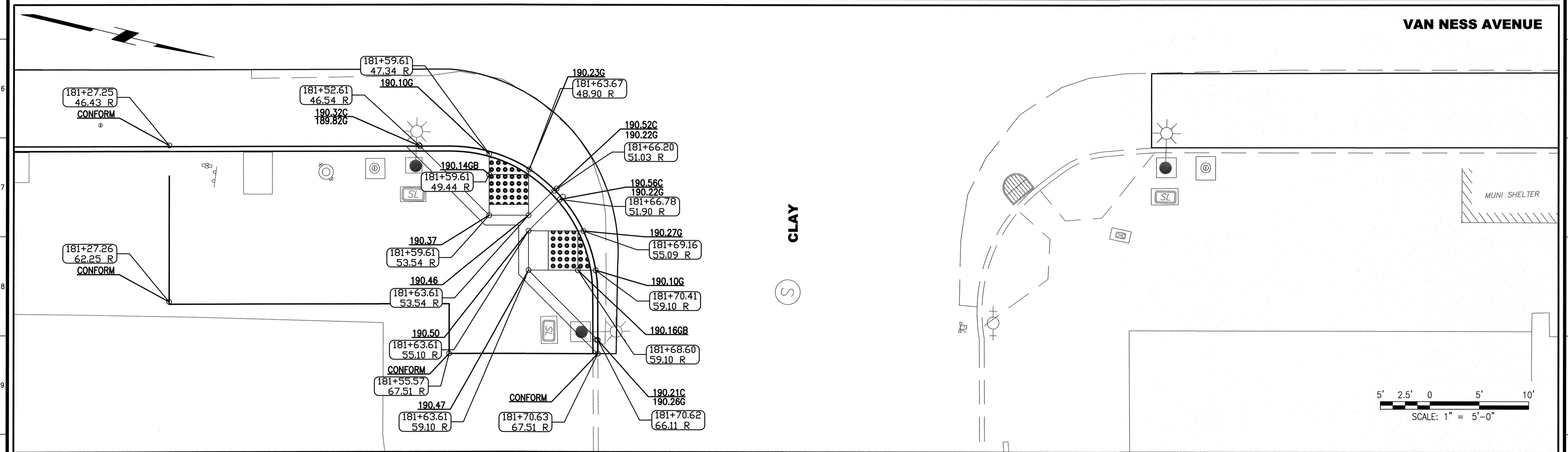
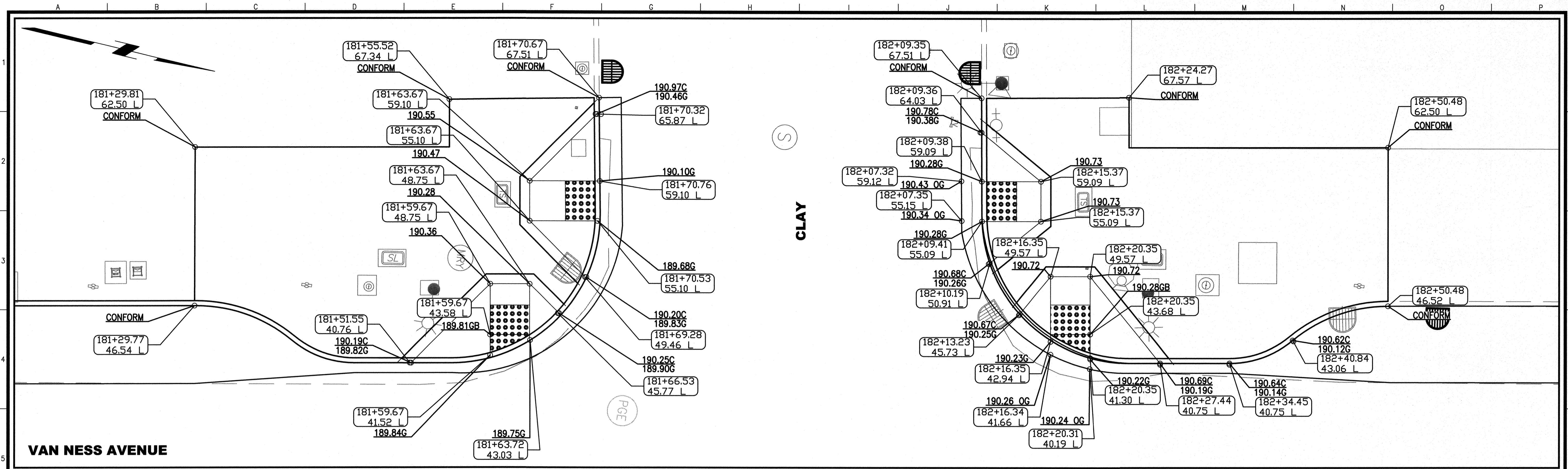

NO.	DATE	DESCRIPTION	BY	APP.
TABLE OF REVISIONS				

REFERENCE INFORMATION  
& FILE NO. OF SURVEYS

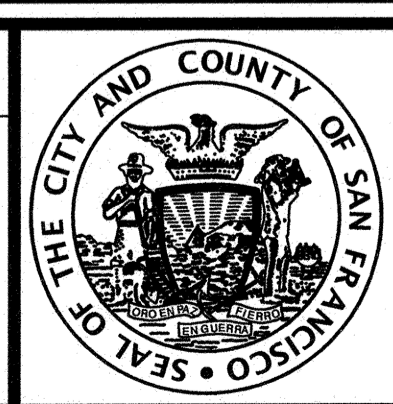

**INFRASTRUCTURE DIVISION**  
DEPARTMENT OF PUBLIC WORKS  
CITY AND COUNTY OF SAN FRANCISCO

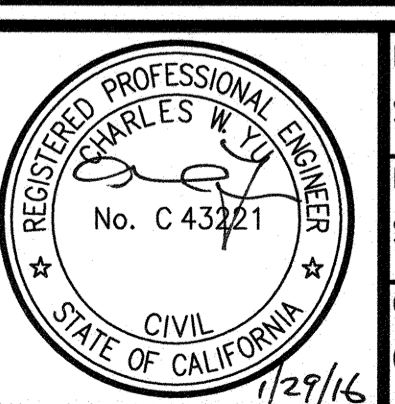

DESIGNED:	DATE:	APPROVED:	DATE:
S.YUAN	7/15	<i>Meammar Collin</i>	2/16
DRAWN:	DATE:	SECTION MANAGER:	DATE:
S.YUAN	7/15	<i>Paul &amp; Lin</i>	2/16
CHECKED:	DATE:	DEPUTY DIVISION MANAGER:	DATE:
C.YU	7/15	<i>Paul S. Dunn</i>	2/16
		DIVISION MANAGER:	DATE:

SCALE:  
1" = 5' - 0"

SHEET OF SHEETS  
---- OF ----

MUNI BUS RAPID TRANSIT SYSTEM  
VAN NESS CORRIDOR TRANSIT IMPROVEMENT PROJECT

ROAD WORK  
BULB & CURB RAMP DETAILS  
CLAY ST

CONTRACT NO.	1289
DRAWING NO.	CR-133
FILE NO.	101,455
REV. NO.	0



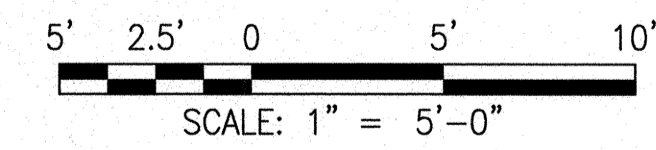
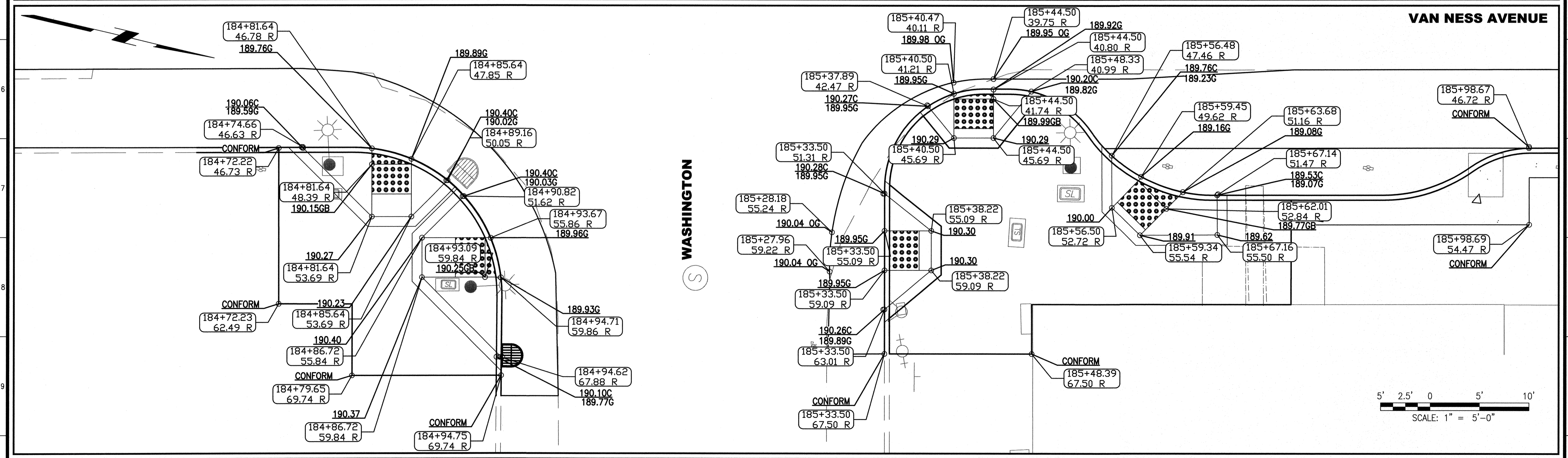
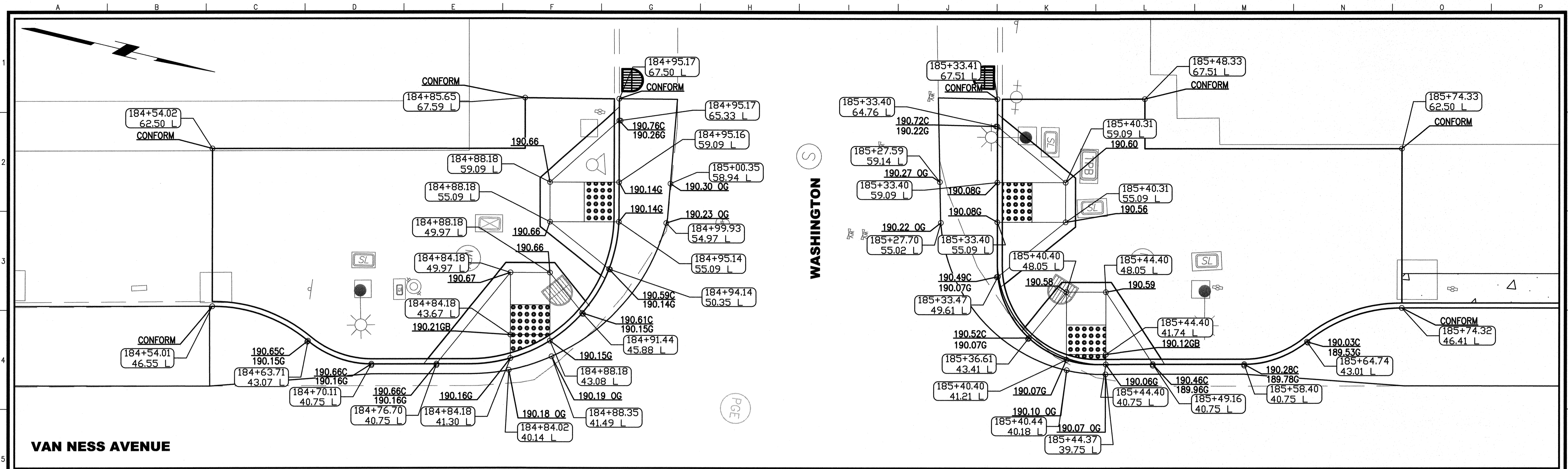

NO.	DATE	DESCRIPTION	BY	APP.
TABLE OF REVISIONS				

REFERENCE INFORMATION  
& FILE NO. OF SURVEYS

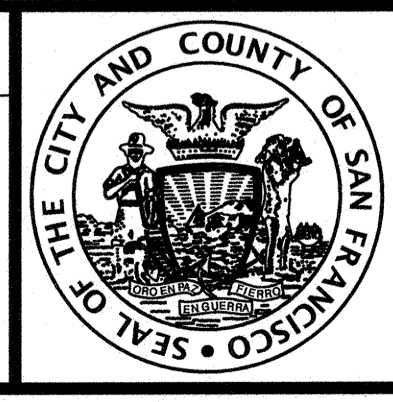

**INFRASTRUCTURE DIVISION**  
DEPARTMENT OF PUBLIC WORKS  
CITY AND COUNTY OF SAN FRANCISCO

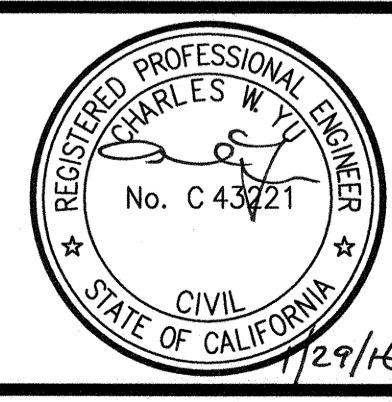

DESIGNED: S.YUAN 7/15  
DRAWN: S.YUAN 7/15  
CHECKED: C.YU 7/15

APPROVED: *Alfonso Colon* 7/16  
SECTION MANAGER  
*Paul Davis* 2/3/16  
DEPUTY DIVISION MANAGER  
*Paul Davis* 2/3/16  
DIVISION MANAGER

SCALE: 1" = 5'-0"  
SHEET OF SHEETS  
--- OF ---

MUNI BUS RAPID TRANSIT SYSTEM  
VAN NESS CORRIDOR TRANSIT IMPROVEMENT PROJECT  
ROAD WORK  
BULB & CURB RAMP DETAILS  
WASHINGTON ST

CONTRACT NO. 1289  
DRAWING NO. CR-134  
FILE NO. 101,456  
REV. NO. 0

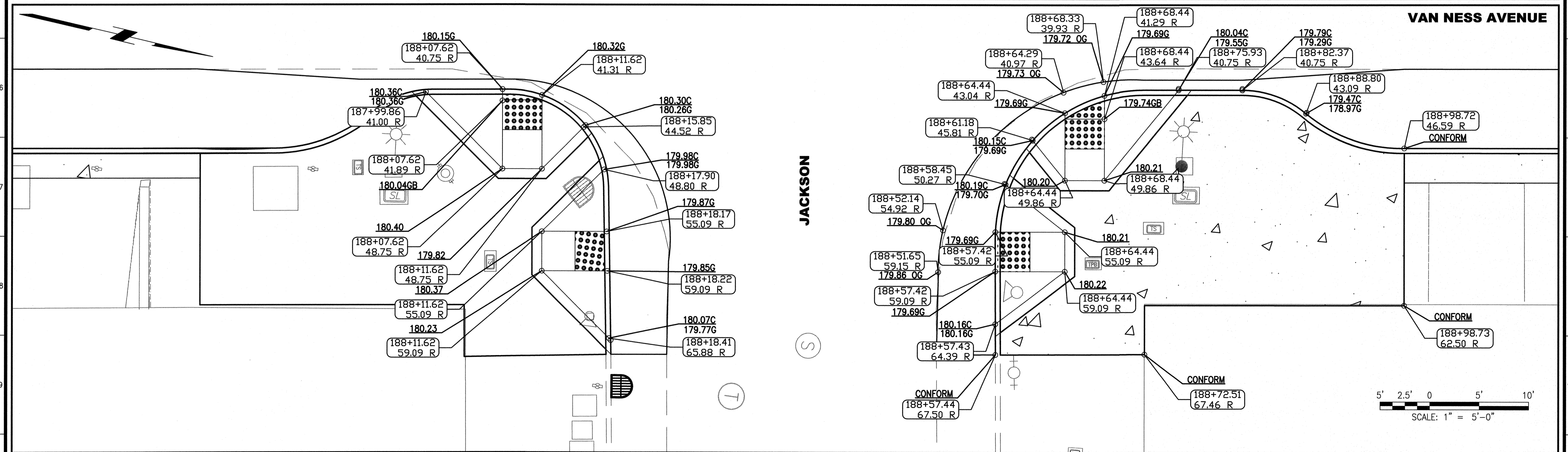
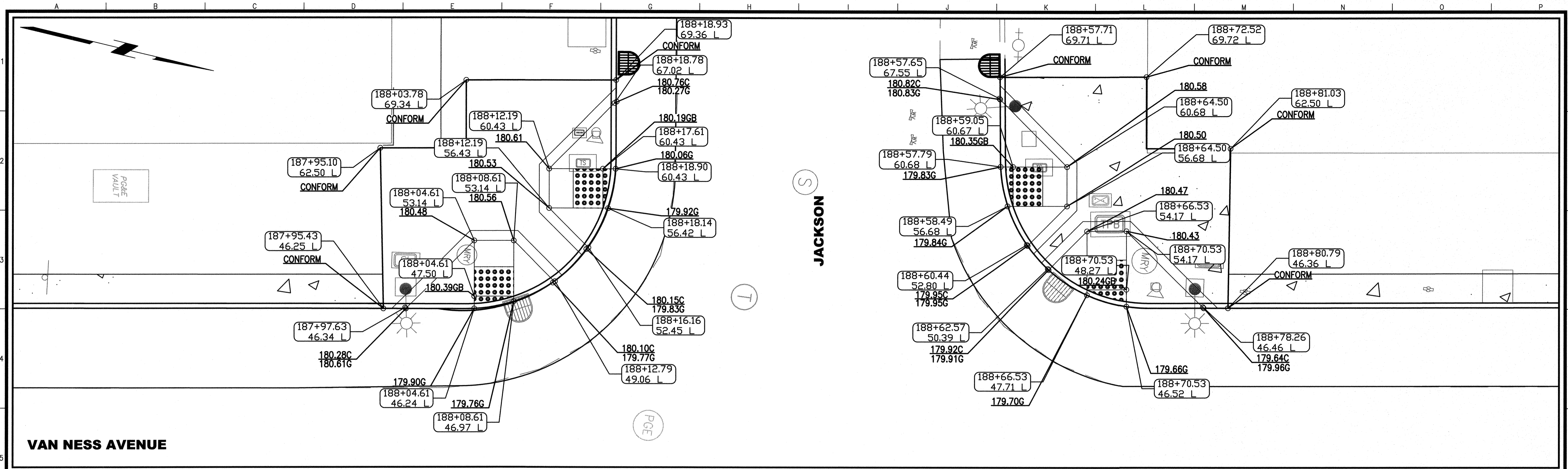

NO.	DATE	DESCRIPTION	BY	APP.
TABLE OF REVISIONS				

REFERENCE INFORMATION  
& FILE NO. OF SURVEYS



**INFRASTRUCTURE DIVISION**  
DEPARTMENT OF PUBLIC WORKS  
CITY AND COUNTY OF SAN FRANCISCO

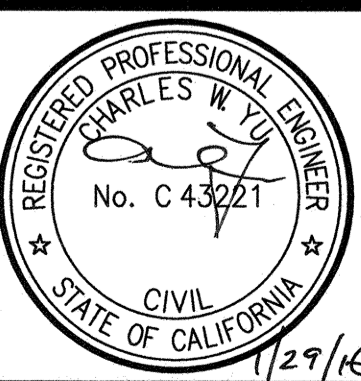

DESIGNED: S.YUAN 7/15  
DRAWN: S.YUAN 7/15  
CHECKED: C.YU 7/15

APPROVED: *Manasseh Calles* 7/16  
SECTION MANAGER  
*Felix Lim* 2/3/16  
DEPUTY DIVISION MANAGER  
*John Martin* 4/3/16  
DIVISION MANAGER

SCALE: 1" = 5'-0"  
SHEET OF SHEETS  
--- OF ---

MUNI BUS RAPID TRANSIT SYSTEM  
VAN NESS CORRIDOR TRANSIT IMPROVEMENT PROJECT  
ROAD WORK  
BULB & CURB RAMP DETAILS  
JACKSON ST

CONTRACT NO. 1289  
DRAWING NO. CR-135  
FILE NO. 102,457  
REV. NO. 0

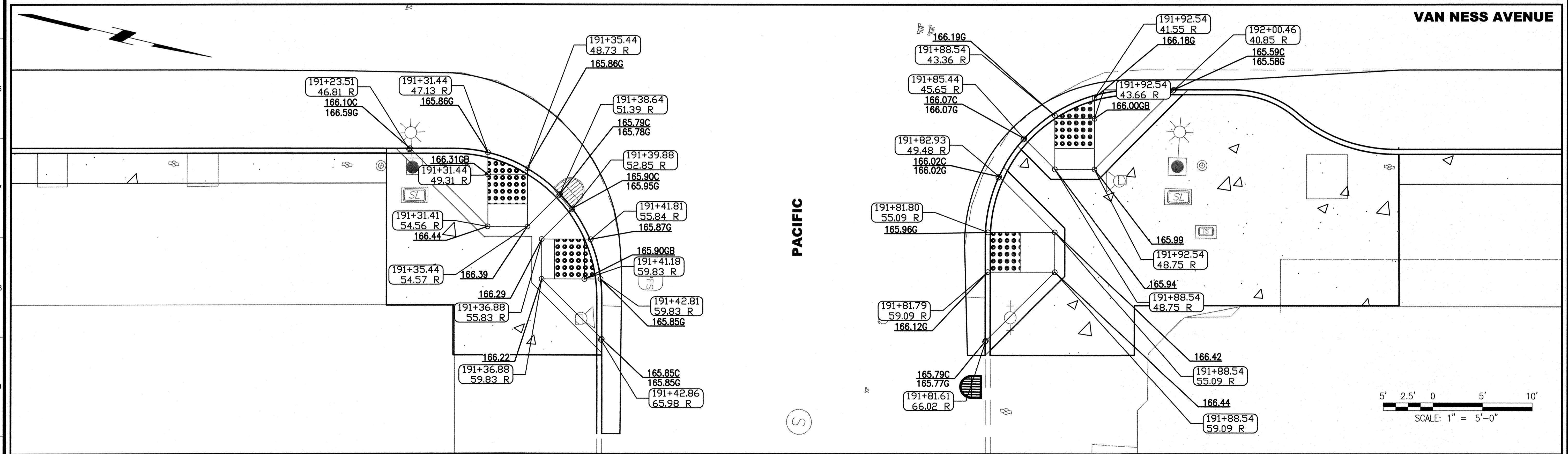
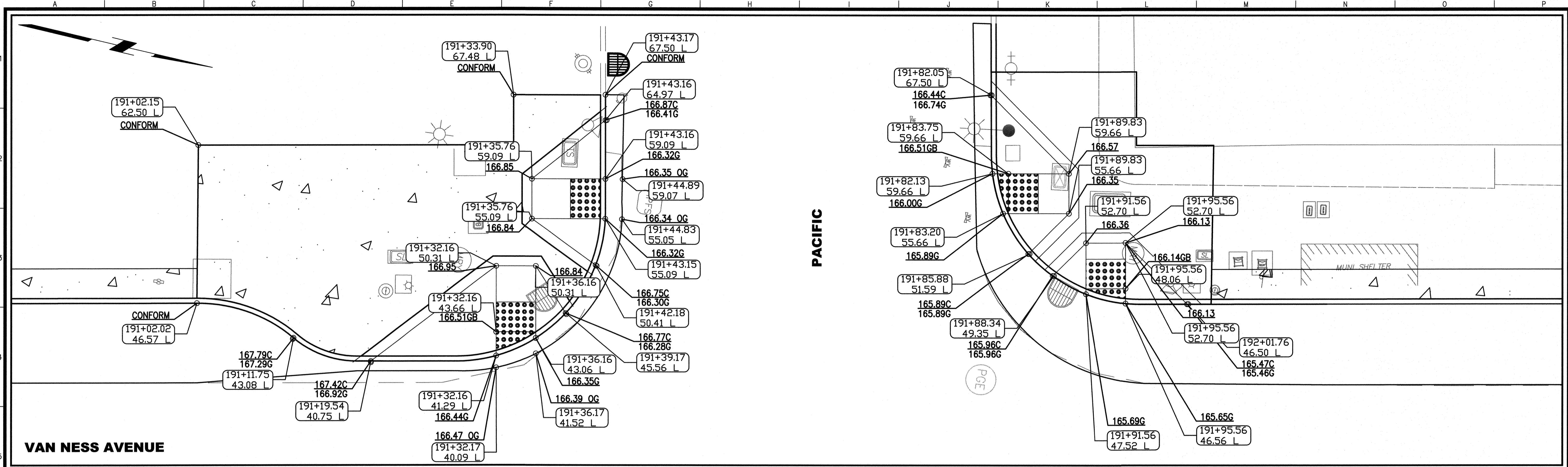

NO.	DATE	DESCRIPTION	BY	APP.
TABLE OF REVISIONS				

REFERENCE INFORMATION  
& FILE NO. OF SURVEYS

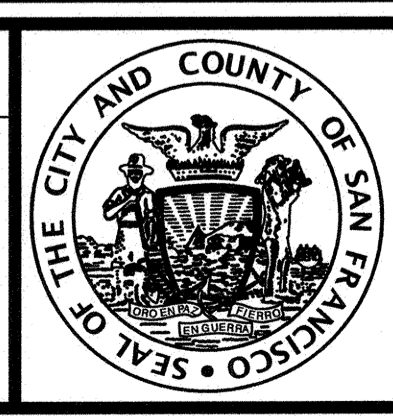

**INFRASTRUCTURE DIVISION**  
DEPARTMENT OF PUBLIC WORKS  
CITY AND COUNTY OF SAN FRANCISCO

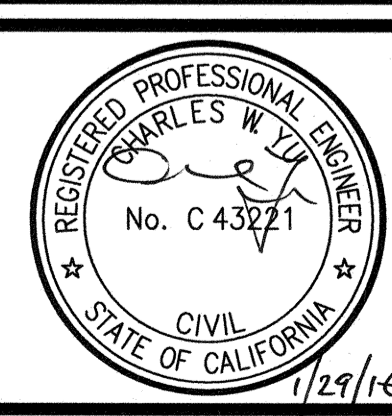

DESIGNED: S.YUAN 7/15  
DRAWN: S.YUAN 7/15  
CHECKED: C.YU 7/15

APPROVED: *Alanna M. Collier* 7/21/16  
SECTION MANAGER  
*Paul J. Davis* 2/3/16  
DEPUTY DIVISION MANAGER  
*Paul J. Davis* 2/3/16  
DIVISION MANAGER

SCALE: 1" = 5' - 0"

SHEET OF SHEETS  
--- OF ---

MUNI BUS RAPID TRANSIT SYSTEM  
VAN NESS CORRIDOR TRANSIT IMPROVEMENT PROJECT

ROAD WORK  
BULB & CURB RAMP DETAILS  
PACIFIC ST

CONTRACT NO. 1289  
DRAWING NO. CR-136  
FILE NO. 101,458  
REV. NO. 0



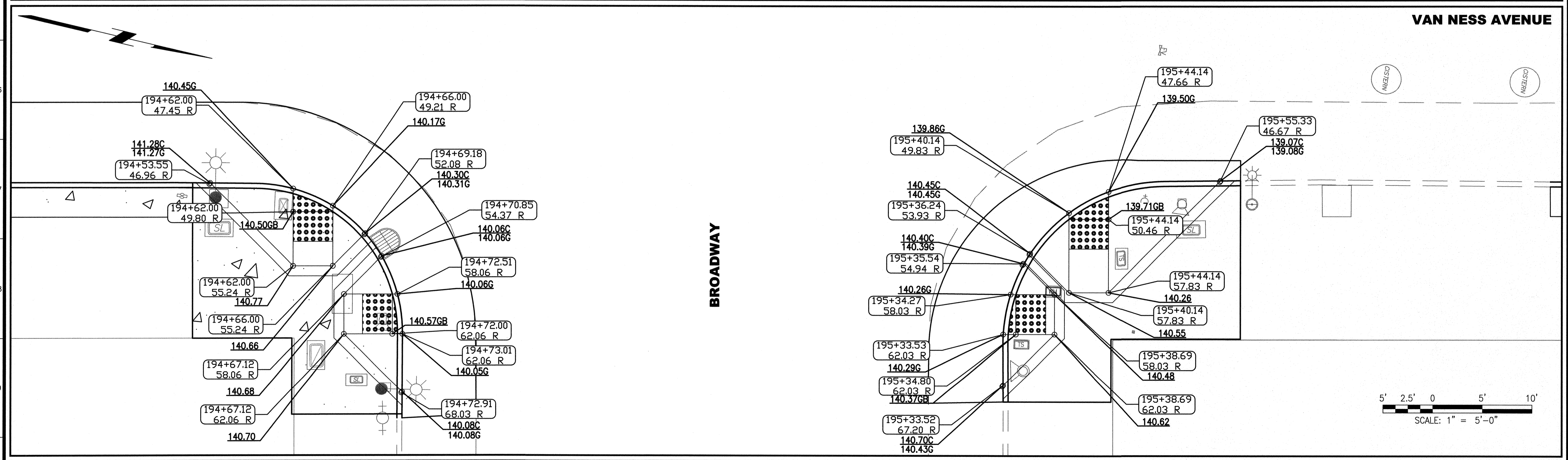
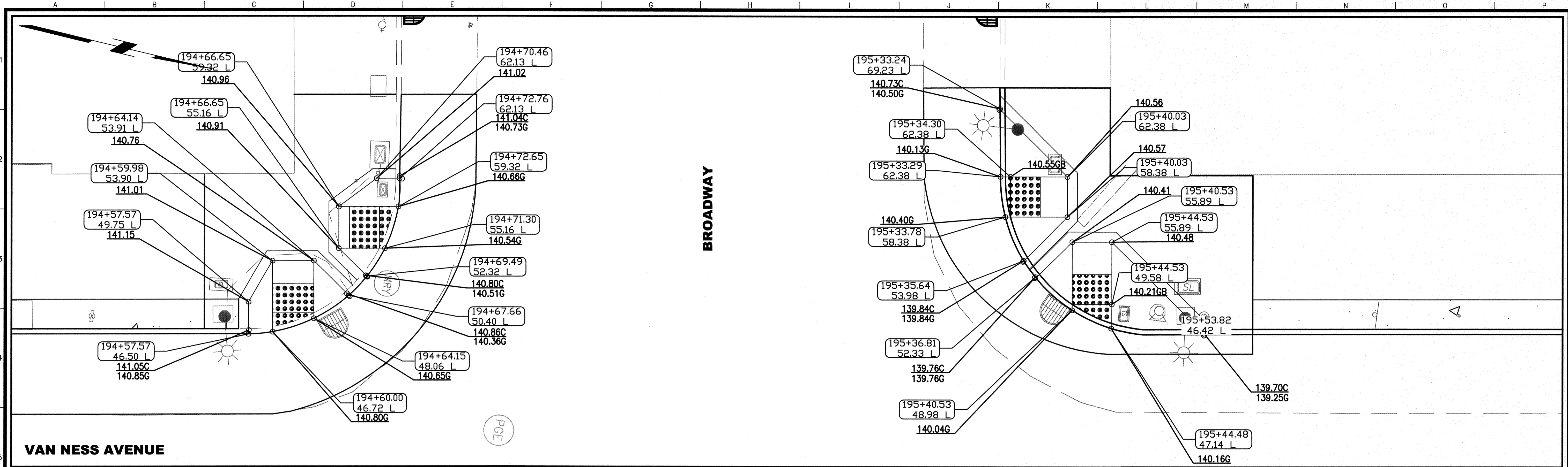

NO.	DATE	DESCRIPTION	BY	APP.
TABLE OF REVISIONS				

REFERENCE INFORMATION  
& FILE NO. OF SURVEYS



**INFRASTRUCTURE DIVISION**  
DEPARTMENT OF PUBLIC WORKS  
CITY AND COUNTY OF SAN FRANCISCO



DESIGNED:	DATE:	APPROVED:	SCALE:
S.YUAN	7/15	<i>Charles W. Yu</i>	1" = 5' - 0"
DRAWN:	DATE:	SECTION MANAGER:	SHEET OF SHEETS
S.YUAN	7/15	<i>Charles W. Yu</i>	--- OF ---
CHECKED:	DATE:	DEPUTY DIVISION MANAGER:	
C.YU	7/15	<i>Charles W. Yu</i>	
		DIVISION MANAGER:	

MUNI BUS RAPID TRANSIT SYSTEM  
VAN NESS CORRIDOR TRANSIT IMPROVEMENT PROJECT  
ROAD WORK  
BULB & CURB RAMP DETAILS  
BROADWAY ST

CONTRACT NO.	1289
DRAWING NO.	CR-137
FILE NO.	102,459
REV. NO.	0

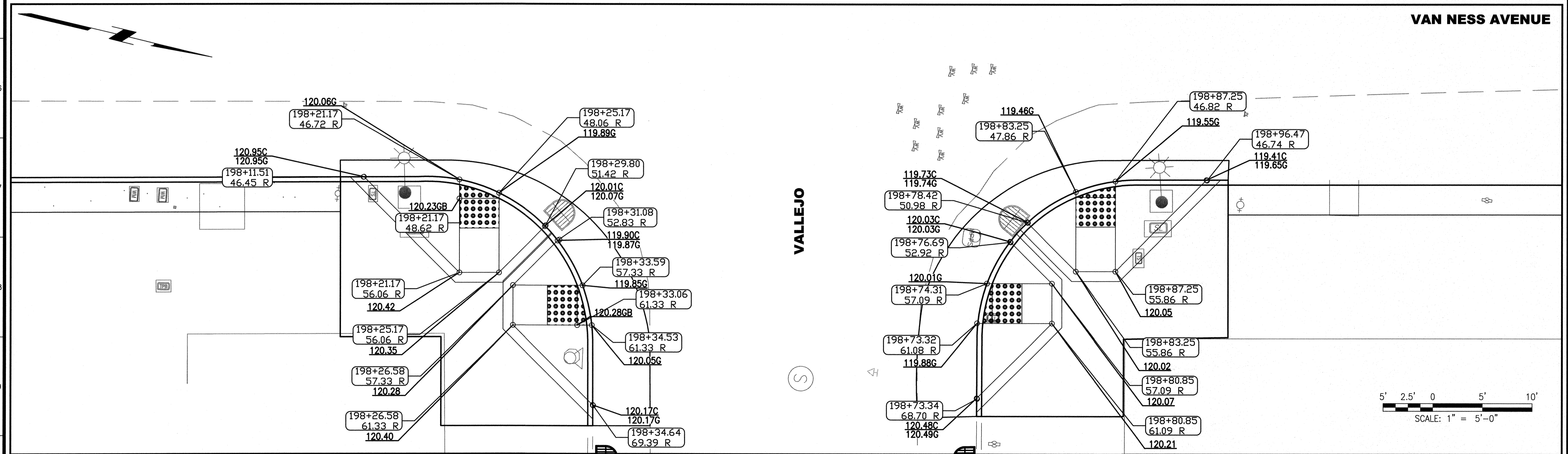
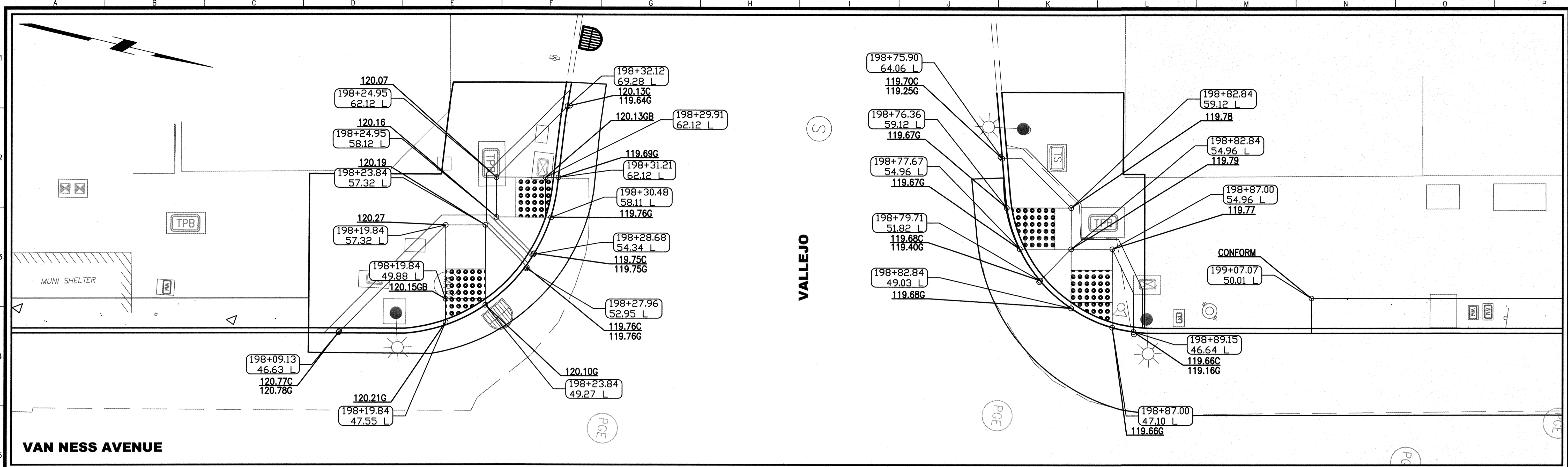

NO.	DATE	DESCRIPTION	BY	APP.
TABLE OF REVISIONS				

REFERENCE INFORMATION  
& FILE NO. OF SURVEYS

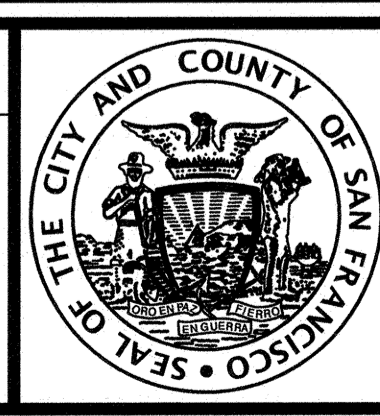

**INFRASTRUCTURE DIVISION**  
DEPARTMENT OF PUBLIC WORKS  
CITY AND COUNTY OF SAN FRANCISCO

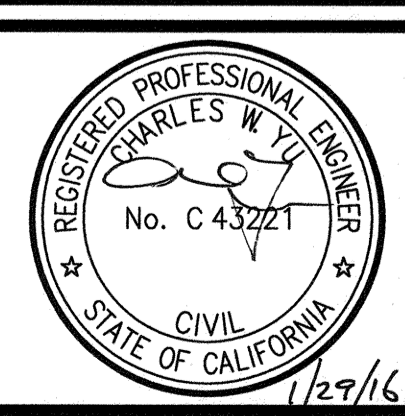

DESIGNED: S.YUAN 7/15  
DRAWN: S.YUAN 7/15  
CHECKED: C.YU 7/15

APPROVED: *Charles W. Yuan* 2/2/16  
SECTION MANAGER DATE:  
*Paul J. Davis* 2/3/16  
DEPUTY DIVISION MANAGER DATE:  
*Richard M. Davis* 2/3/16  
DIVISION MANAGER DATE:

SCALE: 1" = 5'-0"  
SHEET OF SHEETS  
--- OF ---

MUNI BUS RAPID TRANSIT SYSTEM  
VAN NESS CORRIDOR TRANSIT IMPROVEMENT PROJECT

ROAD WORK  
BULB & CURB RAMP DETAILS  
VALLEJO ST

CONTRACT NO. 1289  
DRAWING NO. CR-138  
FILE NO. 102,460  
REV. NO. 0