



SFMTA

Municipal
Transportation
Agency

Bicycle Parking: Standards, Guidelines, Recommendations



Updated: December 3, 2015

Created: November 18, 2011



SFMTA
Municipal
Transportation
Agency

ABOUT US

The San Francisco Municipal Transportation Agency (SFMTA) is responsible for the planning, implementation, regulation, maintenance and operation of the multimodal transportation system in the City and County of San Francisco. The city's transportation system includes transit, paratransit, streets, bicycle and pedestrian facilities, parking, traffic controls, and taxi services.

Board of Directors

Tom Nolan | Chairman

Cheryl Brinkman | Vice-Chairman

Malcolm A. Heinicke

Joél Ramos

Cristina Rubke

Gwyneth Borden

Director of Transportation

Edward Reiskin

Sustainable Streets Contributing Staff

Bridget Smith

Seleta Reynolds

Heath Maddox

Matt Lasky

Will Tabajonda

Ryan Dodge

Jessica Kuo

Hannah Polow

Eric Tuvel

Earl Kaing

CONTENTS

1	Introduction	4
	1.1 Overview	5
	1.2 Using the Guide	5
2	Background	7
	2.1 Guiding Policies	9
	2.2 Bicycle Parking Classifications	9
	2.3 Existing Facilities	10
3	Learning from Experience	11
	3.1 Qualities of Good and Poor Bicycle Racks	12
4	Planning for Short-term Bicycle Parking	14
	4.1 Benefits of Short-Term Bicycle Parking	15
	4.2 Considerations for Implementation	15
5	SFMTA Short-Term Sidewalk Bicycle Parking Installation	17
	5.1 Types of Short-Term Bicycle Parking	18
	5.2 Citywide Short-Term Bicycle Parking Installation	18
	5.3 SFMTA Short-Term Bicycle Parking Planning and Installation	19
6	Non-Standard Options for Short-Term Bicycle Parking	26
	6.1 Gifting Sidewalk Bicycle Racks	27
7	Long-Term Bicycle Parking	28
	7.1 Benefits	29
	7.2 Types of Long-Term Bicycle Parking	29
	7.3 Implementation of Long-Term Bicycle Parking	29
8	Monitored Bicycle Parking	33
	8.1 Required Amount	34
	8.2 Placement and Demarcation	34
9	Bicycle Rack Specifications	35
	9.1 Functional Specifications	36
	9.2 Rack Material	36
	9.3 Surface Mounting	37

APPENDIX

A	Relevant City Policies	38
A.1	San Francisco City Charter Section 8A.115 Transit First Policy	38
A.2	Planning Code Section 155.1-4	39
A.3	Tenant Bicycle Parking in Existing Commercial Buildings Ordinance	50
A.4	Transportation Code Section 909	50
A.5	Better Streets Plan Section 6.5: Site Furnishings	51
A.6	Other Relevant Policy	51
B	Bicycle Rack Gift Agreement	53
C	Off-Street Bicycle Parking Placement Guidelines	54
D	Bicycle Rack Specifications	63
E	Select Bicycle Parking Vendors	65
E.1	Lockers	65
E.2	Racks	65

FIGURES

f.1	Bicycle Parking Typology Diagram	9
f.2	Existing Short-Term Bicycle Parking in San Francisco (2012)	10
f.3	Short-Term Bicycle Parking in San Francisco (from left to right): Circular Rack (Standard), Inverted U Rack (Previous Standard), Meter Post Ring	19
f.4	Acceptable Zone for Sidewalk Bicycle Racks	20
f.5	Detailed Bicycle Rack Clearances	22
f.6	Specifications for typical on-street bicycle corral with standard circular bicycle rack	23
f.7	Custom Rack Design Gifted to the SFMTA from the YBCBD	27
f.8	Example Indoor Racks (from left to right): Wall, Stacked, Wall, and Stacked	30
f.9	Typical single-user bicycle locker (left), electronic lockers in El Cerrito (right)	31
f.10	Sample Bicycle Locker Layout	31
f.11	Example Indoor Bicycle Parking Sign	32
f.12	Typical Bicycle Rack: Inverted U-Rack and Circular Rack	36
f.13	Typical SFMTA Sidewalk Rack Mounting Hardware Expansion Bolt (top left), Mushroom Spike (top right) and flange (bottom)	37

TABLES

t.1	Bicycle Parking Types	9
t.2	Examples of Good and Poor Bicycle Parking	13
t.3	Sidewalk Width Requirements for Bicycle Parking	21
t.4	Required Bicycle Rack Clearances on the Sidewalk	21
t.5	Bicycle Rack Placement in Bus and Colored Curb Zones	21
t.6	Bicycle Corral Application, Design and Review, and Installation Schedule	24
t.7	Preferred, Not Recommended and Excluded Locations for Bicycle Corrals	25
t.8	Bicycle Locker Materials Construction Elements	32

1

Introduction

This introductory chapter provides an overview of the SFMTA bicycle parking standards and describes the chapters to outline the best way to use this Guide.



1.1 Overview

The San Francisco Transportation Code grants the San Francisco Municipal Transportation Agency (SFMTA) authority to install and to authorize the installation of bicycle parking within the city's public rights-of-way. This document, the SFMTA Bicycle Parking Standards, Guidelines, Recommendations ("Guide") provides standards, guidance and best practices for bicycle parking planning and implementation in San Francisco.

This Guide provides bicycle parking information regarding appropriate and recommended:

- Types of bicycle parking.
- Placement of bicycle parking in relation to other street furniture and objects adjacent to the sidewalk such as curbs, walls, and parked cars.
- Installation of bicycle parking, including the approval process for locations in the public realm.
- Typical locations for installing long-term bicycle parking.
- Specifications for the most appropriate bicycle parking materials.

This Guide goes beyond the requirements for bicycle parking in the San Francisco Planning Code and provides information to assist anyone interested in helping meet the increasing demand for bicycle parking in San Francisco. It is intended to serve as a comprehensive citywide resource not only for SFMTA staff and other city agencies; information provided will also prove useful for architects, landscape architects, urban designers, planners, engineers, private property owners, developers, contractors and the general public when choosing, planning and implementing both short- and long-term bicycle parking.

1.2 Using the Guide

The Guide is a resource for those interested in how the SFMTA places bicycle parking in the public right-of-way as well as how other public agencies or private parties can install bicycle parking on public and private property. The Planning Code gives requirements for the amounts of bicycle parking necessary with building projects; this Guide is the best reference for determining the spacing, materials, specifications, and overall best practices for building short- and long-term bicycle parking. Below is a summary of the chapters in these guidelines.

Chapter 2 discusses relevant bicycle parking policies in San Francisco, summarizes the different types of bicycle parking and describes the existing facilities in San Francisco.

Chapter 3 defines features of good bicycle parking and includes examples of good and bad bicycle parking.

Chapter 4 provides a description of short-term bicycle parking in San Francisco, including the benefits, considerations for implementation and suitable land uses for short-term parking facilities.

Chapter 5 includes the SFMTA procedures for installing sidewalk bicycle racks and bicycle corrals in San Francisco. Procedures include how to request these short-term bicycle parking facilities, the application and installation process, and rack and corral placement guidelines. These placement guidelines apply to anyone installing short-term bicycle parking in the public right-of-way or on private property.

Chapter 6 describes how private property owners and community groups can work with the SFMTA to develop unique bicycle parking on an individual property, neighborhood or district-wide basis.

Chapter 7 provides an overview of different types of long-term bicycle parking and what property owners and managers should consider prior to implementation.

Chapter 8 provides information and requirements for monitored bicycle parking in San Francisco.

Chapter 9 details bicycle rack specifications and hardware used for installation. These requirements are necessary for public agencies and private entities installing bicycle racks in San Francisco.

2

Background

This chapter discusses relevant bicycle parking policies in San Francisco and defines different types of bicycle parking and the existing amount of these facilities in San Francisco.



2.1 Guiding Policies

A number of City and County of San Francisco policy documents reference bicycle parking. Section 2.1 highlights the overall goals for the SFMTA and the SFMTA's Livable Streets subdivision as they relate to bicycle parking in San Francisco. Appendix A includes a review of other City and County of San Francisco policy documents relevant to bicycle parking including San Francisco City Charter Section 8A.115 Transit First Policy, Planning Code Section 155.1-4, San Francisco Tenant Bicycle Parking in Existing Commercial Buildings Ordinance, Transportation Code Section 909, and Better Streets Plan Section 6.5: Site Furnishings.

SFMTA STRATEGIC PLAN

The SFMTA Fiscal Year 2013-2018 Strategic Plan outlines the SFMTA's vision and goals for the next five years and the vision is San Francisco: great city, excellent transportation choices. To achieve this vision there are four strategic goals and improving and increasing bicycle parking fits into the second goal: *Make transit, walking, bicycling, taxi, ridesharing & carsharing the preferred means of travel.* To help meet this Agency vision and subordinate goal, the SFMTA plans, manages, and implements bicycle parking in San Francisco.

SFMTA LIVABLE STREETS

The Livable Streets Subdivision within the Sustainable Streets Division of the SFMTA is responsible for implementing most publicly available bicycle parking in San Francisco. Livable Streets improves and enhances San Francisco's public rights-of-way to make bicycling a safe, viable transportation option for people of all ages, abilities and levels of willingness to mix with automobiles. The Subdivision accomplishes this through planning, engineering and implementing bicycle facilities, including bicycle parking, and educating the community and agencies about bicycle transportation.

Livable Streets is responsible for reviewing and fulfilling short-term bicycle parking requests and coordinating and assessing bicycle parking with other City agencies. SFMTA Off-Street Parking manages the existing bicycle lockers in the City parking garages.

2.2 Bicycle Parking Classifications

In general, bicycle parking falls into two categories: short-term (sometimes referred to as class II), and long-term (class I). Short-term parking serves people leaving bicycles for two hours or less. While racks for short-term parking should be designed, built and installed with security in mind, overall there is an emphasis on convenience and accessibility. Long-term parking is for bicycle parking needs of longer than two hours and for people who bike that may be willing to travel further to access it in exchange for greater security and protection from the elements.

This Guide provides specification, location, and implementation details for short-and long-term bicycle parking. Figure 1 presents the different types of bicycle parking for each classification referenced in this document and Table 1 provides brief descriptions for the parking types described in this Guide.

Figure 1 Bicycle Parking Typology Diagram

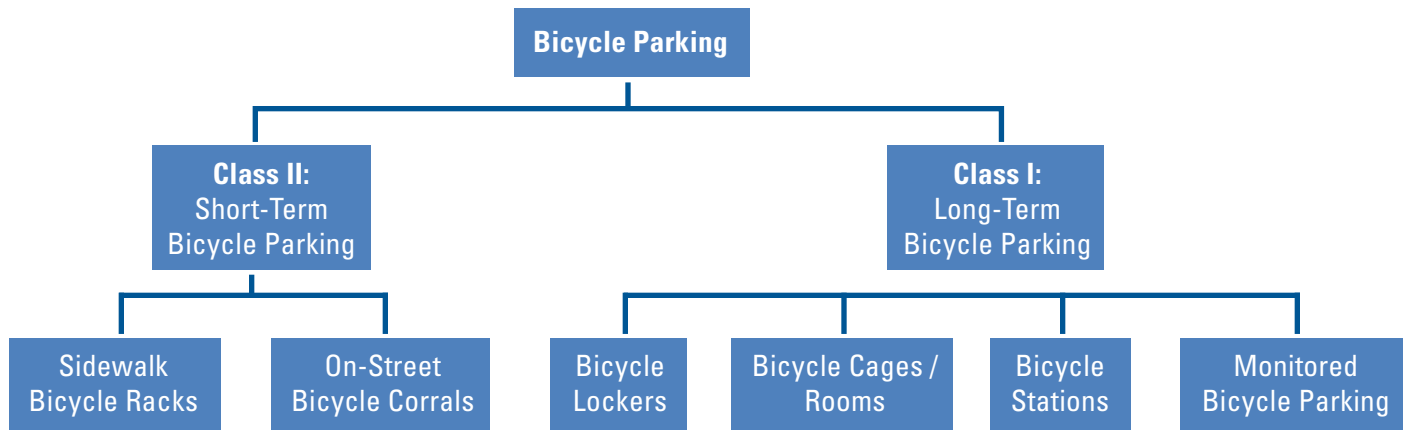

Table 1 Bicycle Parking Types

Class	Parking Type	Description
Class II: Short-Term Bicycle Parking	Sidewalk Bicycle Racks and Meter Bicycle Rings	Placed throughout San Francisco on the sidewalk Installed most commonly by the SFMTA
	On-Street Bicycle Corrals	Placed in the roadway parking lane Located where demand is greater than can be accommodated on the sidewalk Typically fits 8-12 bicycles per auto parking space
Class I: Long-Term Bicycle Parking	Bicycle Lockers	Locked storage box for a bicycle Fits one bicycle Highly secure parking Traditional one-user-one-key or on-demand cardkey-operated electronic lockers that serve multiple users
	Bicycle Cages / Rooms	Fenced cage or room Bicycles park to bicycle racks Key, keypad or cardkey access control
	Bicycle Stations	Secure room or storefront Usually located near a transit hub Bicycles park to bicycle racks Self-serve or valet service If self-serve: key, keypad or cardkey access control locked with one point of entry
	Monitored Bicycle Parking	Set-up for large public events Roped off or fenced areas Greeters check bicycles in/out One point of entry Bicycles parked to temporary racks
	School Bicycle Parking	Parking for students and staff during school days Typically racks inside a fenced area

Regardless of parking classification, many facilities employ standard racks to satisfy bicycle parking requirements. Bicycle cages, on-street corrals, bicycle rooms, and conventional sidewalk bicycle parking can all make use of basic racks. Racks come in a variety of shapes and sizes in San Francisco; the most common rack type is the inverted U-rack. In 2012, the SFMTA changed its standard sidewalk rack from the inverted U- to a circular rack.

2.3 Existing Facilities

With its extensive, innovative and well-used bikeway network, San Francisco is a leading bicycle city. The bicycle network currently has over 200 miles of bicycle paths, lanes and routes and the network is steadily growing due to the SFMTA's ongoing efforts; annual counts show that bicycling is on the rise. To support the increasing numbers of people biking and encourage more people to travel by bicycle, the SFMTA has installed and continually maintains over 3,000 sidewalk bicycle racks, more than 60 on-street bicycle corrals and nearly 50 bicycle lockers. Figure 2 presents a map of the existing sidewalk bicycle racks and corrals in San Francisco. Additionally, bicycle parking installed and maintained by other public agencies and private parties is located throughout the city, including on properties controlled by the Port and the Recreation and Parks Department, racks and cages/rooms on private property and long-term bicycle parking at the Embarcadero BART station and the Caltrain Terminal.

Figure 2 Existing Short-Term Bicycle Parking in San Francisco (2012)

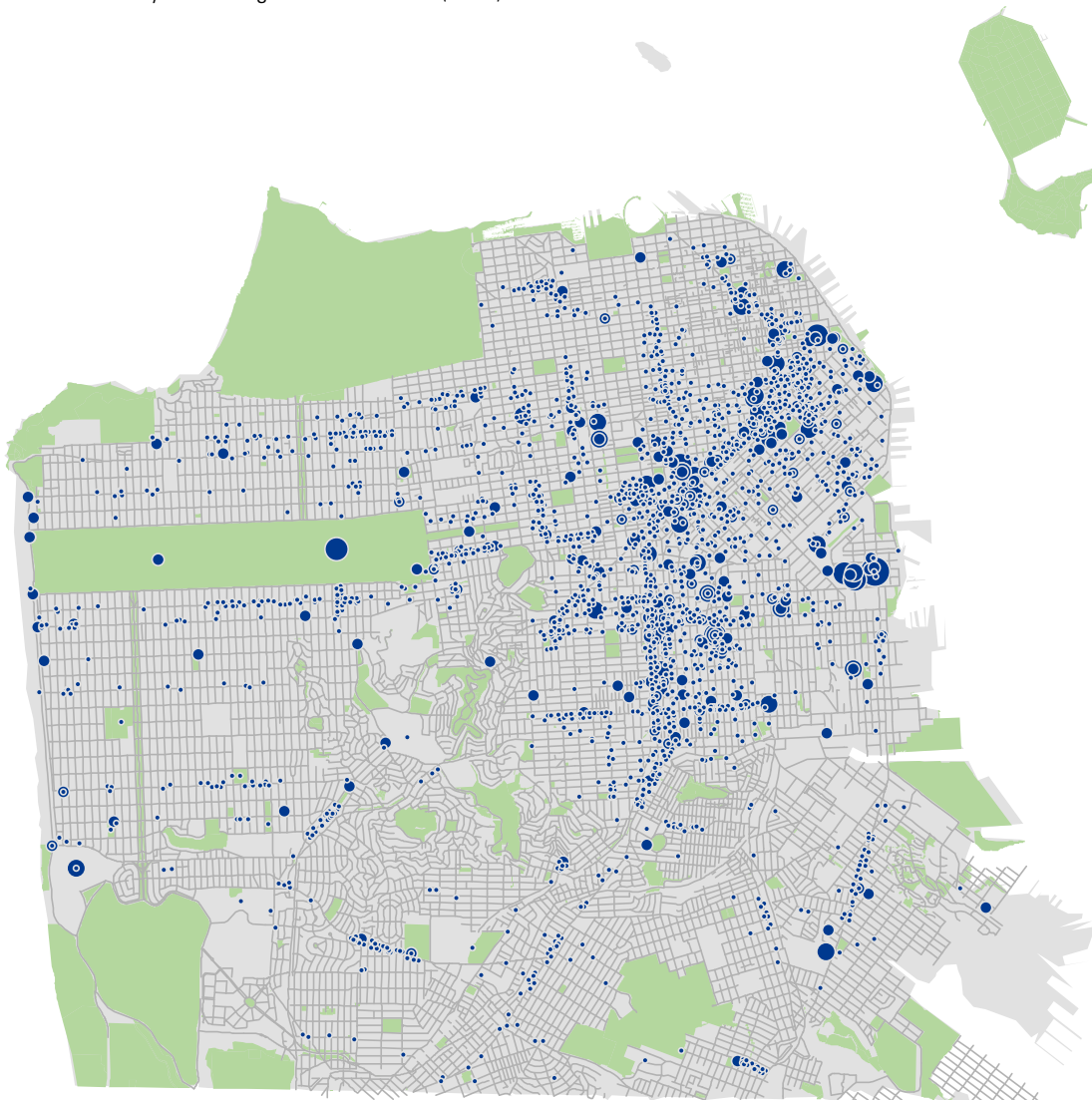

3

Learning from Experience

Chapter 3 defines the features of good bicycle parking and includes examples of good and bad bicycle parking.



3.1 Qualities of Good and Poor Bicycle Racks

Bicycle parking plays a key support role to the bicycle network. San Francisco has a latent demand for bicycle infrastructure; more people would be enticed to ride bicycles if the proper support facilities were more widely available. There is a steady volume of requests to the SFMTA for more bicycle racks in San Francisco and perennial waitlists for bicycle lockers. An SFMTA survey found that over 80 percent of respondents are more likely to bicycle if secure bicycle parking facilities were available at destinations, another testament to the tremendous demand for these facilities.

Providing good bicycle parking is not as simple as it may seem and bad examples are unfortunately all too common. If not overlooked completely, bicycle parking is often viewed as a mundane and unexciting feature of the built environment that requires little attention. At the other extreme, well-intentioned attempts to dress bicycle parking up can easily yield unsatisfactory results.

Bicycle parking **should** be:

- Widely available and decentralized – an abundant supply of bicycle parking near destinations complements the inherent flexibility of bicycles as a mode of travel.
- Intuitive – bicycle parking should be easy to understand and use for all types of people biking.
- Low maintenance – bicycle parking should be sturdy and require little or no work to maintain.
- Economical – to provide bicycle parking in sufficient quantity to begin to meet citywide demand, the racks themselves need to be reasonably affordable.

Bicycle parking **should not** be:

- Painted or powder coated – to keep from rusting, racks made from steel tubing should be coated with zinc (hot dip galvanized) or made of stainless steel. Especially in a marine environment like San Francisco, paint and powder coating do not last, eventually chipping, flaking and creating maintenance issues.
- Susceptible to pipe cutters – circular tubing, one of the most common materials for bicycle racks, can easily and quietly be cut with a relatively small, portable pipe cutter.
- Placed too closely to adjacent street furniture, walls, and curbs – racks should have an adequate buffer to easily accommodate bicycles and allow them to easily enter and exit an area without interfering with pedestrian access (see Chapter 5).
- Needlessly expensive – the most expensive bicycle parking is not necessarily the best bicycle parking. In fact, expensive racks are often not functional, intuitive or durable and therefore go unused, are misused or do not last.

Table 2 provides several examples of good bicycle parking that meet the SFMTA's guidelines and overall bicycle parking best practices as well as bicycle parking that does not meet the highest standards.

Table 2 Examples of Good and Poor Bicycle Parking

The Good



Bicycle Corral, Powell Street at Chestnut Street



Sidewalk Bicycle Racks, Valencia Street



Sidewalk Art Rack, San Francisco



Sidewalk Rack,
Yerba Buena
Community
Benefit District

The Not So Good



Round-tubed wave rack with flaking powder coat over galvanized finish



Round tubes cut with pipe cutter and rust under powder coat finish*



Unintuitive, unattractive design, insufficient space between racks



Round tubed wave rack hidden from sight and too close to the wall



Unintuitive design, does not support bicycle at two points†



Unintuitive design, does not support bicycle at two points†



Expensive, unintuitive design, round tubes, and flimsy construction



Good rack placed too close to a wall

*Source: Association of Pedestrian and Bicycle Professionals (APBP). Bicycle Parking Guidelines, 2nd Edition. 2010

†Source: Forms + Surfaces® Site Furniture: Bike Racks 2013

4

Planning for Short-Term Bicycle Parking

This chapter provides a description of short-term bicycle parking in San Francisco, including the benefits, and considerations for implementation. Short-term bicycle parking includes sidewalk racks and on-street bicycle corrals.



4.1 Benefits of Short-Term Bicycle Parking

In addition to serving the most basic goal of providing a place for people to lock their bikes, short-term bicycle parking has numerous benefits, including enhancing the overall streetscape of an area, granting building owners credit toward LEED certification (Leadership in Energy and Environmental Design), and potentially increased profits for retail businesses. More discussion of these three points is below.

STREET AMENITY

Adequate supply of bicycle parking contributes to orderly, usable and enjoyable streetscapes, prevents damage to trees and street furniture from parked bicycles, and keeps bicycles from falling over and blocking the sidewalk.¹ Bicycle parking also increases foot traffic to a place, thereby increasing the “eyes on the street” and general security for street users.

LEED CERTIFICATION

LEED Certification scores buildings on a point system for overall environmental sustainability. Example categories for points include: efficiency, transportation, material consumption, and fossil fuel usage. Provision of bicycle parking earns buildings credits for LEED Certification. To qualify for the credit, commercial, institutional and/or residential buildings must provide secure bicycle parking within 200 yards of a building entrance.

Buildings must provide secure bicycle racks for five percent or more of all building occupants measured at peak use; showering facilities must also be provided. For residential buildings, covered bicycle racks must be provided for 15 percent of the occupants but no showering facilities are required.² More information is available on the US Green Building Council’s webpage: <http://www.usgbc.org>.

ECONOMIC BENEFIT

Bicycle parking provides an economic advantage to nearby businesses. Numerous studies from around the world have found that people arriving by bicycle spend more money on average than those traveling by vehicle. Bicyclists have a tendency to spend less per trip but take more trips, and in the end, spend more money.³ Studies have also found that bicycle parking is more cost efficient than vehicle parking. For example, a study in Melbourne, Australia found that each square meter allocated to bicycle parking generated \$31 in spending per hour, compared to \$6 generated for each square meter of car parking.⁴

4.2 Considerations for Implementation

Prior to the installation of bicycle parking, the SFMTA evaluates existing and future bicycle parking demand and existing site conditions.

DEMAND

The SFMTA places sidewalk bicycle racks primarily by request in areas with demonstrated and expected demand. The Agency receives over 30 bicycle rack requests per month.⁵ Typically, evidence of demand for racks is easy to identify: bicycles are locked to meters, signs, trees, railings and other street furniture. Where demand for short-term bicycle parking is proven and where sidewalk racks will not suffice, the SFMTA considers installation of on-street bicycle corrals.

1 Association of Pedestrian and Bicycle Professionals (APBP). Bicycle Parking Guidelines, 2nd Edition. 2010

2 Dero, LEED Credits for Bike Parking: <http://www.dero.com/leed.html>

3 Den Haag, Habitat Platform Foundation, I-cc Interface for Cycling Expertise and the Association of Dutch Municipalities (VNG). The economic significance of cycling: a study to illustrate the costs and benefits of cycling policy, 2000.

4 March, A., & Lee, A. (2010). Recognising the economic role of bikes: sharing parking in Lygon Street, Carlton. Australian Planner, 47(2), 85-93.

5 Average bicycle parking requests have increased since 2010. Average monthly requests per year since 2010- 2010:19, 2011:27, 2012:32.

GROWTH POTENTIAL

Even during the initial planning and installation of short-term bicycle parking, consideration should be given to how and where the supply can be subsequently increased. Bicycle parking should be planned and installed to allow for additional capacity to be added in the future when demand is likely to increase. If possible, the placement of racks should not occur in a manner that removal and repositioning is necessary to accommodate more racks.

RECOMMENDED LOCATIONS

The SFMTA targets the following land uses and destinations for bicycle rack installation; these land uses tend to have the greatest bicycle parking demand.

- Commercial districts
- Schools
- Libraries
- Transit stops
- Service destinations (restaurants, shopping, etc.)

Additionally, the SFMTA reviews locations in the public right-of-way that are changing and maybe able to accommodate bicycle parking; these locations include on:

- Meter poles not in use (retrofit with bicycle parking rings)
- Curb extensions
- Sidewalk bulb-outs

Consistent with the San Francisco Better Streets Plan, when laying out sidewalks as part of streetscape (re)design, bicycle parking is secondary to street trees and street lighting. Supporting furnishings such as bicycle parking and seating should be placed in relation to major defining design elements like trees and light fixtures that set the rhythm and tone for the entire street. For a more thorough discussion of the role of bicycle parking in streetscape design see Section 6.5 of the Better Streets Plan in Appendix C.



Bicycle corral at the San Francisco Main Library



Bicycle Parking on Sidewalk Bulb-Out

5

SFMTA Short-Term Sidewalk Bicycle Parking Installation

This chapter includes the SFMTA procedures for installing sidewalk bicycle racks and bicycle corrals in San Francisco. Procedures include how to request these short-term bicycle parking facilities, the application and installation process and rack and corral placement guidelines.



5.1 Types of Short-Term Bicycle Parking

A variety of short-term bicycle parking exists in San Francisco. For short-term use, the SFMTA installs surface-mounted circular racks on the sidewalk and in the parking lane of the street made of two-inch square galvanized steel tubing.⁶ The SFMTA has also installed a limited number of parking meter post rings in recent years. Since meter posts often serve as de-facto bicycle parking in the absence of an alternative and SFpark is increasingly replacing individual meters with multi-space meters, in some locations after meter removal, the SFMTA installs a sleeve with a bicycle parking ring over the former meter post. Lastly, the SFMTA installs bicycle corrals or clustered inverted U-racks or circle racks in the vehicle parking lane to accommodate bicycles where there is a high demand for short-term bicycle parking. Examples of these short-term bicycle parking options are shown below in Figure 3.

Figure 3 Short-Term Bicycle Parking in San Francisco (from left to right): Circular Rack (Standard Rack), Inverted U Rack (Previous Standard Rack), and Meter Post Ring



5.2 Citywide Short-Term Bicycle Parking Installation

The SFMTA installs the vast majority of San Francisco's bicycle parking in the public right-of-way, generally in line with existing street furniture near the curb and outside the path of pedestrian travel to ensure an unobstructed through zone for pedestrian circulation. As part of other projects, like streetscape projects or building redevelopments, the Department of Public Works (DPW) or private contractors may also install sidewalk bicycle racks.

For those areas of the city that lie outside the jurisdiction of the SFMTA and DPW, providing bicycle parking is the responsibility of another agency or private property owners; examples include:

- San Francisco Unified School District (SFUSD) installs bicycle racks on public school property, primarily for long-term use by students and staff. The SFMTA installs racks on the sidewalk for visitors.
- National Park Service (NPS) manages the Golden Gate National Recreational Areas (GGNRA); these include Crissy Field, and Fort Mason. The NPS installs and maintains bicycle parking in these areas. The Presidio installs their own bicycle racks.
- The Port of San Francisco owns the property immediately surrounding the San Francisco Bay, including the Embarcadero and the Promenade. The Port installs and maintains bicycle parking on Port property.

⁶ Depending on the installation location, older inverted u-racks employed both round and square tubing.

- Recreation and Parks Department (RPD) installs and maintains racks in San Francisco parks throughout the city.
- Private developers and building owners install bicycle racks on private property according to the Planning Code and site-specific demand.

Additionally, neighborhood groups or business associations may wish to install unique bicycle parking in their respective neighborhood or district. In these cases, the organization can work directly with the SFMTA to coordinate design, fabrication and installation details. See 6.1 for additional information.

5.3 SFMTA Short-Term Bicycle Parking Planning and Installation

SIDEWALK RACKS

Requesting a Sidewalk Bicycle Rack

Anyone may request sidewalk bicycle racks by using the web-based 311 system, calling 311, emailing bikeparking@sfmta.com, or by calling 415.646.2330.⁷ Additionally, the San Francisco Bicycle Coalition has an online request form for sidewalk racks linked to the SFMTA's request system. The SFMTA works with the fronting property owner/business to verify these requests as well as opportunities to pursue bicycle corrals.

Sidewalk Bicycle Rack Review and Installation Process

SFMTA staff review bicycle rack requests prior to installation. The review and installation process is as follows:

1. **Confirmation of Request:** Staff checks the bicycle rack request with existing bicycle parking records and contacts the fronting business owner or property manager to confirm that demand for short-term bicycle parking exists.
2. **Field Survey and Marking:** After confirmation of the request, SFMTA staff performs a field investigation of the site and paints a temporary marking on the sidewalk in the most appropriate place for the rack. The marking shows the SFMTA Sign Shop staff the location for the rack installation.
3. **Environmental Review:** After field surveying and markings are complete, SFMTA staff submits a batch of rack locations (30-70) to the Department of City Planning for environmental review and approval.
4. **Installation:** SFMTA staff generates a work order and SFMTA Sign Shop staff visit the marked location, review the survey work and install the bicycle rack.



SFMTA staff paint the sidewalk with markings at approved locations.

⁷ <http://www.sf311.org/index.aspx?page=125>

Sidewalk Bicycle Rack Placement Guidelines

Installation of sidewalk bicycle racks occurs at locations with demand for short-term use of less than two hours. The SFMTA surveys every requested location for bicycle parking prior to marking and installation of a rack. The SFMTA installs sidewalk bicycle parking as close to the desired location as possible without impeding pedestrian travel in the pedestrian throughway zone. Sidewalk bicycle racks installation is primarily in the furnishings zone, as shown in Figure 4.

Figure 4 Acceptable Zone for Sidewalk Bicycle Racks

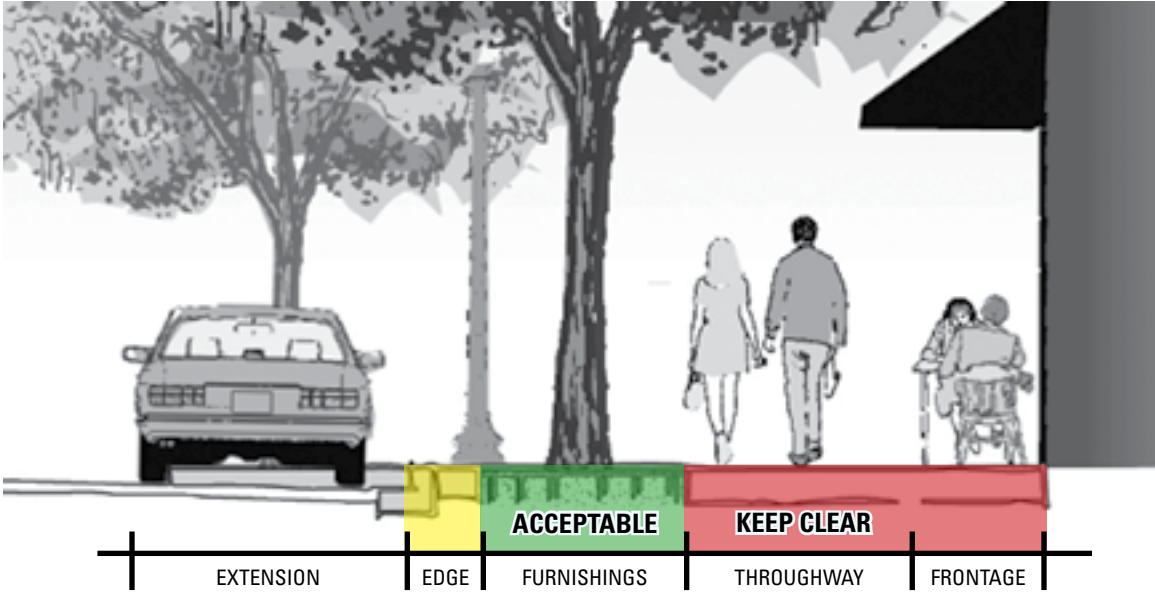

For the installation of sidewalk bicycle parking, the SFMTA has specific clearances necessary from curbs, street furniture, and permitted parking lane uses (color curb zones). These standards help ensure that racks and bicycles parked at racks on the sidewalk do not intrude into the pedestrian throughway zone. Table 3 - Table 5 list the minimum and recommended sidewalk widths and clearances from other street furniture and colored curb and bus zones necessary for the installation of sidewalk bicycle racks.

In some instances, due to unique conditions at a particular location and based upon planning and engineering judgment, the SFMTA may install racks differently than specified in this guide. See Figure 5 for a graphic representation of this information.

Table 3 Sidewalk Width Requirements for Bicycle Parking

Description	Recommended Clearances (feet) [Minimum required]	Location
Necessary Sidewalk Widths for Bicycle Rack Installation	10 [9]	Between curb face and building or café seating (commercial)
	10 [7]	Between curb face and building (residential)
	7 [6]	Between bicycle rack and building or café seating (commercial)
	7 [4]	Between bicycle rack and building (residential)

Table 4 Required Bicycle Rack Clearances on the Sidewalk

Description	Recommended Clearances (feet) [Minimum required]	Object
Bicycle Rack Clearances from other Sidewalk Objects	[0]	In-ground utility pull box (allow enough room to remove cover)
	5 [2]	Tree or tree well; News rack; Trash can; Street light pole; Curbscut / driveway
	10 [7]	Bicycle rack (along curb)
	3	Bicycle rack (parallel to other racks)
	7 [5]	Fire hydrant; Stand pipe (near street)
	[11]	Building Entrance; Stand pipe (near entrances)
	5	Parking meter pole (when placing one rack between two meter poles that are less than 18 feet apart)
	2-4	Angled car parking (depends on placement of meters, car overhang and other objects)
	4	Parking meter pole (when placing two racks between two meter poles that are greater than 18 feet apart)
	5	Traffic sign pole (midblock)
Bicycle Rack Clearances from Parking Types	5 [2]	Traffic sign pole (intersection)
	3 [2]	Parallel car parking
	TBD	Angled car parking
	5	Perpendicular car parking (90-degree)

Table 5 Bicycle Rack Placement in Bus and Colored Curb Zones

Description	Measurement	Location
Back of Zone	Within back 28 feet	Bus Zone on near side of an intersection
	Front or Back	Green Zone (short-term vehicle parking)
	Front or Back	White Zone (five minute stopping)
Front of Zone	Within front 18 feet	Bus Zone on far side of an intersection
	Front	Yellow Zone (commercial loading)
Prohibited	-	Blue Zone (accessible parking)



SIDEWALK BICYCLE RACK PLACEMENT GUIDELINES

SFMTA
Municipal Transportation Agency

RECOMMENDED CLEARANCES IN FEET [MINIMUM FEET IN BRACKETS]

Buildings

Sidewalk

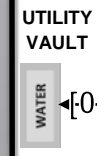
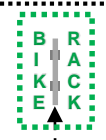

Bike racks shall not be installed on top of utility vaults but may be directly adjacent to them

SIGN OR METER POLE



See Table 4

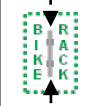

7 [2]

XWALK

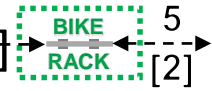
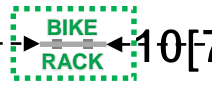
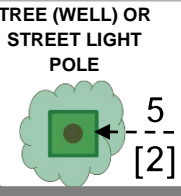
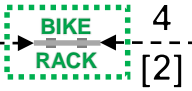
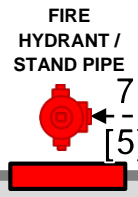

YELLOW ZONE (commercial)

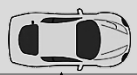

BLUE ZONE (accessible)



GREEN ZONE (short-term parking)

WHITE ZONE (5-minute stopping)

ANGLED PARKING

90-DEGREE PARKING

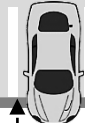

front ✓

3 [2]



BIKE RACK ✓



front or back ✓

3

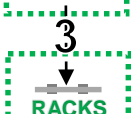

front or back (case-by-case) ?

See Table 4

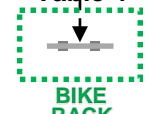

5

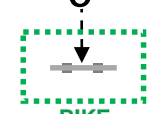

Pedestrian Throughway Clearance (between parked bike and building or café seating)

[6] COMMERCIAL
[4] RESIDENTIAL

Building or Café Seating

Door Entrance or Stand Pipe

Sidewalk

Far-Side Bus Zone

within FRONT 20' and REAR 10' See Appendix F

Near-Side Bus Zone

within REAR 30' See Appendix F

Sidewalk Width
[9] COMMERCIAL
[7] RESIDENTIAL

Buildings

NOT TO SCALE. IMAGES ARE FOR ILLUSTRATIVE PURPOSES ONLY. REVISED OCTOBER 2016.

Requesting a Bicycle Parking Corral

Businesses may request a bicycle corral by submitting the bicycle corral application available on the SFMTA website here: <http://www.sfmta.com/cms/bpark/documents/SFMTAOn-StreetBicycleParkingCorrals.pdf>

The application asks for a description of the existing bicycle parking demand since corrals are for locations where demand is greater than can be accommodated by sidewalk racks. The SFMTA accepts applications for corrals on an ongoing basis; Table 6 is the typical schedule for bicycle corral application review dates, design and review periods, and installation. Up to five bicycle corrals each quarter are brought through the SFMTA legislation and public hearing approval process for installation in the subsequent quarter. The SFMTA installs up to 20 bicycle corrals per year.

Table 6 Bicycle Corral Application, Design and Review, and Installation Schedule

Application Due	Survey / Design / Review / Public Hearing Period	Installation
January 1	January – March	April – June
April 1	April – June	July – September
July 1	July – September	October – December
October 1	October – December	January – March

Bicycle Corral Review and Installation Process

SFMTA staff review the bicycle corral applications and perform a site investigation for the proposed corral location prior to installation. The process for implementation is as follows:

- 1. Survey** – SFMTA staff determines if a bicycle corral is an appropriate facility given the demand for bicycle parking or whether sidewalk racks are more appropriate. If for any reason a bicycle corral is not recommended then SFMTA staff will survey the location for sidewalk bicycle racks upon request. Applicants may request another bicycle parking count if lack of demand was the primary reason for the application rejection.
- 2. Design and Legislation** – If recommended for installation, SFMTA staff design the proposed bicycle corral and following further SFMTA and interagency review, schedule a public hearing for final approval. The SFMTA always posts notices in the project area prior to the public hearing date.
- 3. Installation:** If approved, SFMTA staff installs the bicycle corral after a public hearing. Pending current workload and weather conditions, installation typically occurs within five weeks of the hearing.

8 If repaving is scheduled, the corral application will be placed on hold until after repaving is complete.

Bicycle Corral Placement Guidelines

The SFMTA has preferred, not recommended, and excluded locations for bicycle corrals as listed below in Table 7.

Table 7 Preferred, Not Recommended and Excluded Locations for Bicycle Corrals

Preferred
<ul style="list-style-type: none">• Where existing demand is for five or more bicycles (three or more bicycle racks)• At an intersection (improving sightlines for crossing pedestrians and other roadway users)
Not Recommended (But Feasible)
<ul style="list-style-type: none">• White curb zones (five minute passenger loading/unloading)• Green curb zones (short-term car parking)• Yellow curb zones (commercial loading zone)• Motorcycle parking spaces
Excluded
<ul style="list-style-type: none">• Blue curb zones• Bus zones• Fire hydrant zones (within less than five feet of hydrant)• Tow-Away zones where the parking lane periodically serves as a travel lane• Roadway segment scheduled for repaving within 12-15 months⁸

If SFMTA staff does not recommend a bicycle corral at a location, the applicant may reapply if one of the following issues applies:

- Demonstrated increase in bicycle parking demand.
- A scheduled roadway project is complete.
- The reason is no longer applicable or has changed so that a bicycle corral is now feasible.

⁸ If repaving is scheduled, the corral application will be placed on hold until after repaving is complete.

6

Non-Standard Options for Short-Term Bicycle Parking

This chapter discusses an option for private entities or individuals to have something other than the standard city rack installed by gifting (donating) one or more non-standard racks to the City for a specific location or group of locations.



6.1 Gifting Sidewalk Bicycle Racks

Where individual property owners, merchant groups or community benefit districts desire to have unique or distinctive bicycle racks installed, the party may choose to purchase or design and fabricate one or more non-standard racks and gift the rack(s) to the SFMTA for free installation.

With the gift process, there is greater flexibility with choice of finishes, materials and shape/profile, but gift racks, whether custom-designed or off-the-shelf, need to largely conform to the SFMTA's functional specifications as detailed in section 9.1 of this document. Donors must be prepared to work with SFMTA staff on selection or design of racks and must provide detailed design drawings and specifications to the SFMTA for review and approval, including information on construction material, dimensions, and plan and cross-section views. The SFMTA reserves the right to refuse acceptance of any racks that do not meet with staff's approval.

Appendix B is the SFMTA Bicycle Rack Gift Agreement.



Figure 7 Custom Rack Design Gifted to the SFMTA from the Yerba Buena Community Benefit District

7

Long-Term Bicycle Parking

Long-term facilities are for bicycle parking of longer than two hours. The San Francisco Planning Code outlines necessary long-term parking requirements as a condition of permit. This chapter provides an overview of different types of long-term bicycle parking and considerations prior to implementation.



7.1 Benefits

Long-term bicycle parking provides a more secure alternative to short-term bicycle parking and should provide an added measure of shelter. Vandalism and theft of bicycles significantly decrease with greater security at these facilities. Results of a recent citywide survey by the SFMTA indicate that individuals who would otherwise be discouraged from bicycling for fear of theft or exposing their bicycle to the elements are more likely to choose to travel by bicycle when high-quality long-term parking is available. Likewise, the survey showed that those who are already riding bikes would ride more if secure long-term bike parking was made available.

7.2 Types of Long-Term Bicycle Parking

At the most basic level, one method of providing long-term bicycle storage is for property owners and managers to allow bicycles inside homes and workplaces. Effective March 2012, the *San Francisco Tenant Bicycle Parking in Existing Commercial Buildings Ordinance* amended the San Francisco Environment Code to require commercial property owners to either allow tenants to bring their bicycles into the building or to provide a nearby alternate secure bicycle parking location. More formal long-term bicycle parking comes in a variety of different forms, including bicycle rooms/cages, bicycle stations, and various types of bicycle lockers (traditional keyed, electronic, and collective).

Bicycle cages or rooms are required in the San Francisco Planning Code for buildings of certain sizes within specific land use zones. Access to these facilities is often with a keycard which may be specific to an employer, campus or available to the general public. The size and capacity of unattended bicycle cages can be as large as space allows. Use of standard bicycle racks and double-decker racks are usable for parking and locking bicycles where there is limited space and high demand. These parking facilities can be located inside buildings, parking garages or built as stand-alone units where there is adequate space. See Appendix C for the SFMTA's off-street bicycle parking placement guidelines.

Larger, often regionally-oriented bicycle parking stations provide commuters who use a bicycle for the first or last leg of a transit-linked trip with low- or no-cost secure long-term bicycle parking. Two examples of bicycle stations in San Francisco are at the Caltrain Terminal at 4th and Townsend Streets and the bicycle station at the concourse level of the Embarcadero BART station.

Lastly, traditional, electronic, and collective bicycle lockers are other forms of highly secure and flexible long-term bicycle parking that can go in or near transit stations, in parking garages, on the sidewalk, in plazas or wherever there is adequate space and demand. The SFMTA maintains 52 traditional bicycle lockers in six separate City-owned garages and plans to replace them with electronic lockers pending available funding.

7.3 Implementation of Long-Term Bicycle Parking

BICYCLE CAGES AND ROOMS

Bicycle cages and rooms restrict access exclusively to people parking bicycles inside a secure designated area. Typical access control to bicycle cages and rooms is with a key, keypad or cardkey. If vandalism or theft occurs in bicycle cages, cameras often allow the potential for identification of the perpetrator. Membership to restricted-access bicycle parking works best within a discrete group such as residents or employees of a given building. Bicycle rooms are typically located on the ground floor of a building to provide easy access, while cages are often located in basements or parking garages, and, especially in a school setting, can be located outdoors

If bicycle racks inside cages and rooms are inverted-U racks then installation should be in compliance with the SFMTA design specifications (Chapter 5). Additionally, adequate clearance from walls and other fixed objects is necessary to allow parking of bicycles and aisle spacing should allow for:

- Simultaneous users
- Entry and exit from the space
- Lifting of bicycles where there are two-tiered racks¹²

As Figure 8 shows, in rooms and cages with limited space, there are racks that hang bicycles vertically and there are stacked options. Hanging racks must allow for the use of “U” locks that can secure the bicycle frame and the dimensions of the rack must provide adequate clear distance behind the rack for easy maneuvering. If stacked racks are used, the second level should offer a device that assists with lifting the bicycle up on the rack. If space allows, these racks should be used in combination with standard floor racks since they are easier to use.



Figure 8 Example Indoor Racks (from left to right): Wall, Stacked, Wall, and Stacked

BICYCLE STATIONS

Like bicycle cages and rooms, bicycle stations provide secure bicycle parking locations indoors where access is controlled by an attendant, card key or key pad. Bicycle stations differ from these other facilities in that they can offer additional amenities to people who bike like an attendant, or showers and/or lockers, sales of bicycle parts and supplies, and, in some cases, bicycle repairs and rentals. If self-service, bicycle station racks are selected based upon space constraints and whether or not the facility is attended. Hanging racks with vertical offset or stacking double-decker racks are commonly used. Like in bicycle cages and rooms, if stacking racks are used in self-serve stations, the racks should offer assistance with lifting bicycles to the second level.

BICYCLE LOCKERS

Bicycle lockers securely protect a bicycle and its components as well as other related gear, including a helmet, bags, shoes, lights, and clothing. Shape and layout of lockers depend on the existing space and specific site needs but typically one locker fits one bicycle. Two common types of bicycle lockers exist: traditional, keyed individual lockers that are rentable by a single user, and electronic lockers (e-lockers) that are available on-demand on an hourly basis. Placement of bicycle lockers can occur wherever there is adequate space for the containers; typically they range from 22 square feet for an individual locker to 41 square feet for a quad of lockers (four).

¹² Association of Pedestrian and Bicycle Professionals (APBP). Bicycle Parking Guidelines, 2nd Edition. 2010.

to 41 square feet for a quad of lockers (four).¹³ There are also collective bicycle lockers; these are not as common in the US, but more prevalent in European countries such as the United Kingdom, the Netherlands, Germany and Belgium. Collective lockers store up to ten bicycles and can fit into an on-street bicycle parking space (depending on the number of bicycle parking spaces inside). With these collective facilities, users have a key or access code.



Figure 9 Typical single-user bicycle locker (left) and electronic lockers in El Cerrito (right)

Space Requirements

Bicycle lockers are essentially large lockable containers that come in a variety of shapes to fit available space. Clearances are important for lockers as to provide space for access and egress of a bicycle. Sites with greater restrictions and less available space may opt to install lockers that provide two bicycle parking spaces in one traditionally shaped rectangle locker to maximize space. This kind of locker has an opening on each side to allow easy access to each parking spot.

To ensure user friendliness, lockers should have the following characteristics:¹⁴

- Spaced for 90+ degree door opening
- Labeled as bicycle parking
- Posted with directions for use
- Posted with membership information
- Wheel tracked for stacked lockers

An example bicycle locker layout is in Figure 10.

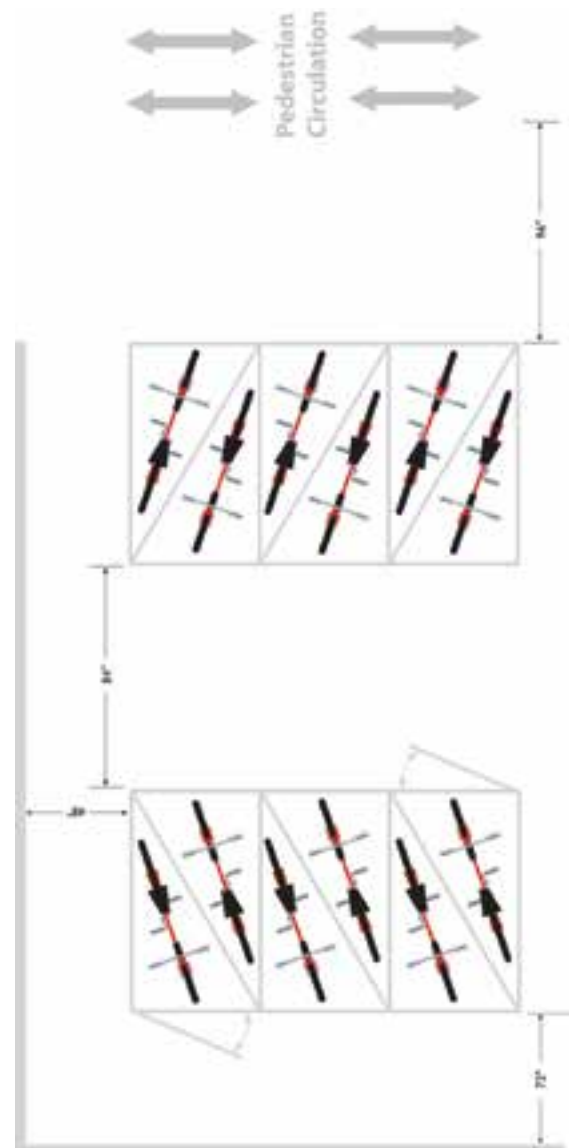

Figure 10 Sample Bicycle Locker Layout ¹⁵

13 "BikeLink™ System Overview," eLock Technologies, 2011, accessed September 24, 2012, <http://elocktech.com/docs/BikeLink%20brochure%20-%20eLocker.pdf>.
 14 Association of Pedestrian and Bicycle Professionals (APBP). Bicycle Parking Guidelines, 2nd Edition. 2010.
 15 Ibid.

Material

The following table describes the common types of bicycle locker materials.

Table 8 Bicycle Locker Materials Construction Elements¹⁶

Type	Notes
All metal	Typically have flat tops, suitable for double stacking. On sunny days, can become very hot, especially if dark colored.
Molded plastic	May have flat or round tops. Care should be taken to choose lockers not made with flammable plastic.
Plastic panel on metal frame	Panels can separate from frame, increasing vulnerability to prying attacks.
Fiberglass panel on metal frame	Stiffness of fiberglass panels prevents prying vulnerability of plastic panels.

SIGNAGE

Long-term bicycle parking should be visible to people biking or relatively easy to access. If the parking facilities are not obvious, then managers of the facilities should provide signs directing people biking to the long-term parking location. Figure 11 is an example sign for directing people biking to bicycle parking.



Figure 11 Example Indoor Bicycle Parking Sign

¹⁶ Association of Pedestrian and Bicycle Professionals (APBP). Bicycle Parking Guidelines, 2nd Edition. 2010.

8

Monitored Bicycle Parking

This chapter provides information and requirements for temporary monitored bicycle parking in San Francisco. Monitored bicycle parking uses portable racks that can be stored on-site or brought to a large public event and set up quickly and easily. A secure area is typically roped or fenced off and staff or volunteers check bicycles in and out. Monitored bicycle parking greatly reduces theft potential, clutter at events, barriers to pedestrian travel, and can potentially increase attendance if secure bicycle parking is advertised in advance of the event.



8.1 Required Amount

In San Francisco, monitored bicycle parking is required for events with an anticipated number of participants greater than 2,000 per day. When issuing a street closure permit, the SFMTA requires:

- Sufficient monitored bicycle parking to accommodate at least one percent of the expected daily participants
- Monitored bicycle parking to be located within a one block radius of a regular entrance to the event
- All event publicity should include information on the monitored bicycle parking including availability, location and cost (the event sponsor may charge a small fee which would cover the cost of providing this service)
- Bicycle parking must receive an equal amount of advertising space as other transportation information

8.1 Placement and Demarcation

Monitored bicycle parking should be located in places free of obstructions and where possible, on open flat surfaces. The location should be clearly marked as monitored bicycle parking to avoid complications with people biking and walking. For recurring events, event organizers should count the number of parked bicycles for future planning efforts.



Monitored bicycle parking at the 2012 Hardly Strictly Bluegrass Festival¹⁷

¹⁷ SF Weekly Blogs. The Traffic For Hardly Strictly Bluegrass Is Going to Be Insane: A Warning. 10/2/2012. http://blogs.sfweekly.com/shookdown/2012/10/the_traffic_for_hardly_strictl.php

9

Bicycle Rack Specifications

This chapter details SFMTA bicycle rack specifications and hardware used for installation. These requirements are necessary for public agencies and private entities installing bicycle racks in San Francisco.



9.1 Functional Specifications

The SFMTA's choice of bicycle racks seeks to strike a balance between economy (in both fabrication and maintenance), aesthetics, security and ease of use. Beginning in June 2012, the SFMTA adopted a galvanized square-tubed steel rack with a circular profile as the standard rack. Prior to this change, the standard rack was an inverted-U of the same material. Both racks are shown below in Figure 12 and meet the following functional specifications:

- Support bicycles at two points of contact (preventing fallen bicycles)
- Allow locking of bicycle frames and wheels with U-locks
- Employ square tubes
- Offer a user friendly design
- Minimize maintenance costs (galvanized finish resists corrosion)
- Do not require lifting of the bicycle
- Provide secure mounting
- Are economically priced
- Used in other bicycle friendly cities
- Offer visibility to pedestrians with a minimum height of 31 inches
- Endorsed by the Association of Pedestrian and Bicycle Professionals

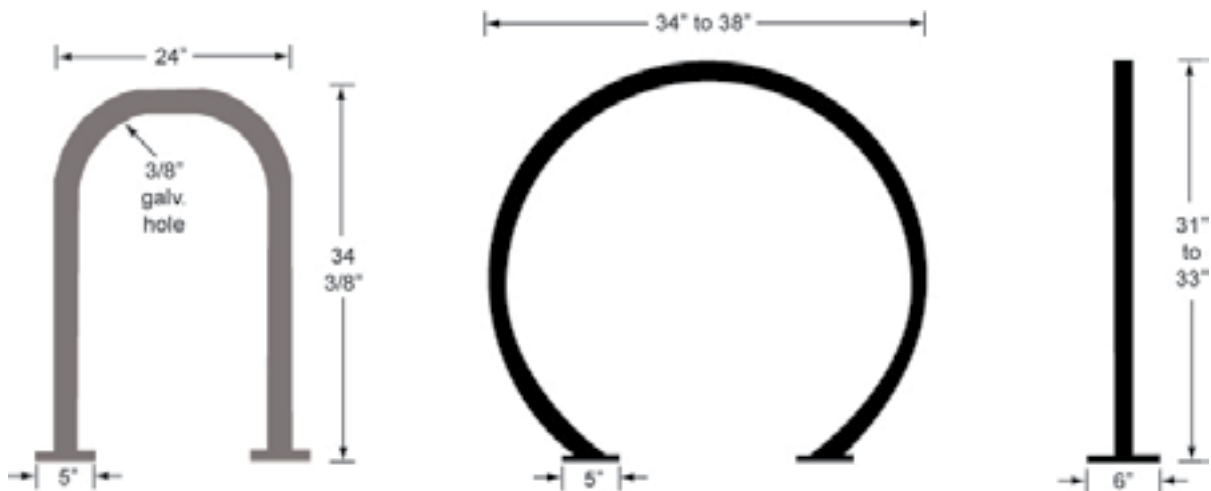

Figure 12 Typical Bicycle Racks: Inverted U-Rack and Circular Rack

9.2 Rack Material

As described above and detailed in Appendix D, the SFMTA specifies racks made of two-inch square schedule 40 structural steel tubing with a hot-dipped galvanized zinc finish.

The bicycle rack wall thickness is .188 inches with flanges attaching to the sidewalk or street that are 3/8 of an inch thick. Hot-dip galvanization produces a thick, durable and matte gray coating that is impervious to rust and extremely durable. *The SFMTA recommends these material specifications for all racks, including those installed on private property.*

There is some room for flexibility in materials for premium applications; for example, more expensive materials than galvanized steel pipe, such as stainless steel or cast ductile iron can provide an acceptable and more attractive alternative. Powder coating, although superior to simple paint, is not an acceptable finish material for outdoor bicycle parking because it is far less durable than galvanization and, especially in a coastal environment like San Francisco, does not sufficiently inhibit rust. Cracked and peeled powder coat cannot practically be re-applied, so unsightly and deteriorating rusty racks are commonly left in place for years. SFMTA staff will consult with San Francisco property owners, managers, city staff or others needing assistance to review specific bicycle rack designs and materials.

9.2 Surface Mounting

Typically, the SFMTA mounts bicycle racks to concrete surfaces or subsurfaces and not asphalt. Bolts and spikes secure bicycle racks to the ground. The SFMTA uses at least one mushroom head Power Spike and one or two expansion bolts per rack leg. The hardware as pictured in Figure 13 meets the specifications listed in Appendix D.

The SFMTA installs sidewalk racks or bicycle corrals on concrete or where there is a concrete sub-surface. For example, on Market Street there is mortared brick material with a concrete sub-surface. The same is true for bicycle corrals where parking lanes are often asphalt but there is a concrete sub-surface. The SFMTA does not install racks on non-mortared brick sidewalks with a sand sub-surface.



Figure 13 Typical SFMTA Sidewalk Rack Mounting Hardware Expansion Bolt (top left), Mushroom Spike (top right) and flange (bottom)¹⁸

Appendices

Appendix A: Relevant City Policies

Many adopted citywide policies encourage bicycling as a viable transportation mode with the implementation of bicycle parking. These policies not only improve the bicycling infrastructure but also encourage people to use bicycles and promote their use to access and park at residential, office and commercial land uses and transit stops and stations.

A.1 San Francisco City Charter Section 8A.115 Transit First Policy

The SFMTA recognizes bicycling as a more affordable and sustainable travel choice than the automobile and establishes this in the City Charter Transit First policy (Section 8A.115). The Transit First policy includes the following two principles that relate to bicycle parking.

Decisions regarding the use of limited street and sidewalk space shall encourage the use of public rights of way by pedestrians, bicyclists and public transit, and shall strive to reduce traffic and improve public health and safety.

Bicycling shall be promoted by encouraging safe streets for riding, convenient access to transit, bicycle lanes and secure bicycle parking.

The complete Transit First Policy follows.

- (a) The following principles shall constitute the City and County's transit-first policy and shall be incorporated into the General Plan of the City and County. All officers, boards, commissions, and departments shall implement these principles in conducting the City and County's affairs:
 1. To ensure quality of life and economic health in San Francisco, the primary objective of the transportation system must be the safe and efficient movement of people and goods.
 2. Public transit, including taxis and vanpools, is an economically and environmentally sound alternative to transportation by individual automobiles. Within San Francisco, travel by public transit, by bicycle and on foot must be an attractive alternative to travel by private automobile.
 3. Decisions regarding the use of limited public street and sidewalk space shall encourage the use of public rights of way by pedestrians, bicyclists, and public transit, and shall strive to reduce traffic and improve public health and safety.
 4. Transit priority improvements, such as designated transit lanes and streets and improved signalization, shall be made to expedite the movement of public transit vehicles (including taxis and vanpools) and to improve pedestrian safety.
 5. Pedestrian areas shall be enhanced wherever possible to improve the safety and comfort of pedestrians and to encourage travel by foot.
 6. Bicycling shall be promoted by encouraging safe streets for riding, convenient access to transit, bicycle lanes, and secure bicycle parking.

7. Parking policies for areas well served by public transit shall be designed to encourage travel by public transit and alternative transportation.
 8. New transportation investment should be allocated to meet the demand for public transit generated by new public and private commercial and residential developments.
 9. The ability of the City and County to reduce traffic congestion depends on the adequacy of regional public transportation. The City and County shall promote the use of regional mass transit and the continued development of an integrated, reliable, regional public transportation system.
 10. The City and County shall encourage innovative solutions to meet public transportation needs wherever possible and where the provision of such service will not adversely affect the service provided by the Municipal Railway.
- (b) The City may not require or permit off-street parking spaces for any privately-owned structure or use in excess of the number that City law would have allowed for the structure or use on July 1, 2007 unless the additional spaces are approved by a four-fifths vote of the Board of Supervisors. The Board of Supervisors may reduce the maximum parking required or permitted by this section.

(Amended by Proposition A, Approved 11/6/2007)

Note

Formerly § 16.102.

A.2 Planning Code Section 155.1-4

The City & County of San Francisco Planning Code requires bicycle parking for new buildings, major renovations, and city buildings

SEC. 155.1. BICYCLE PARKING: DEFINITIONS AND STANDARDS.

- (a) Definitions. The following definitions are listed alphabetically and shall govern Sections 155.1 through 155.4. For the purpose of these Sections, all terms defined below will be in initial caps throughout these Sections.
1. "Attended Facility." A location in which the bicycle is delivered to and left with an attendant with provisions for identifying the bicycle's owner. The stored bicycle is accessible only to the attendant.
 2. "Class 1 Bicycle Parking Space(s)." Spaces in secure, weather-protected facilities intended for use as long-term, overnight, and work-day bicycle storage by dwelling unit residents, non-residential occupants, and Employees.
 3. "Class 2 Bicycle Parking Space(s)." Bicycle racks located in a publicly-accessible, highly visible location intended for transient or short-term use by visitors, guests, and patrons to the building or use.
 4. "Director." Director of the Planning Department.
 5. "Employees." Individuals employed by any entity operating or doing business on the subject lot.
 6. "Landlord." Any person who leases space in a building to the City. The term "Landlord" does not include the City.

7. "Locker." A fully enclosed and secure bicycle parking space accessible only to the owner or operator of the bicycle or owner and operator of the Locker.
 8. "Monitored Parking." A location where Class 2 parking spaces are provided within an area under constant surveillance by an attendant or security guard or by a monitored camera.
 9. "New Building." A building or structure for which a new construction building permit is issued after the effective date of the Section as determined in Section 155.1(f).
 10. "Person." Any individual, proprietorship, partnership, joint venture, corporation, limited liability company, trust, association, or other entity that may enter into leases.
 11. "Responsible City Official." The highest ranking City official of an agency or department which has authority over a City-owned building or parking facility or of an agency or department for which the City is leasing space.
 12. "Restricted Access Parking." A location that provides Class 2 bicycle racks within a locked room or locked enclosure accessible only to the owners of bicycles parked within.
 13. "Stacked Parking." Bicycle parking spaces where racks are stacked and the racks that are not on the ground accommodate mechanically-assisted lifting in order to mount the bicycle.
 14. "U-lock." A rigid bicycle lock, typically constructed out of hardened steel composed of a solid U-shaped piece whose ends are connected by a locking removable crossbar.
 15. "Vertical Bicycle Parking." Bicycle Parking that requires both wheels to be lifted off the ground, with at least one wheel that is no more than 12 inches above the ground.
 16. "Workspace." Any designated office, cubicle, workstation, or other normal work area at which an employee typically performs daily work duties and not typically accessible to the public (such as in the case of retail, restaurant, classroom, theater or similar settings) and is not used for circulation. A Workspace shall also exclude anyplace where storage of a bicycle would be hazardous because of the nature of the work being performed in the immediate vicinity, such as in an industrial or medical setting.
- (b) Standards for Location of Bicycle Parking Spaces. These standards apply to all bicycle parking subject to Section 155.2, as well as bicycle parking for City-owned and leased buildings, parking garages and parking lots subject to Section 155.3. Bicycle racks shall be located in highly visible areas as described in subsections below in order to maximize convenience and minimize theft and vandalism.
- (1) Class 1 spaces shall be located with direct access for bicycles without requiring use of stairs. The location of such spaces shall allow bicycle users to ride to the entrance of the space or the entrance of the lobby leading to the space. The design shall provide safe and convenient access to and from bicycle parking facilities. Safe and convenient means include, but are not limited to, ramps and wide hallways as described below. Escalators and stairs are not considered safe and convenient means of ingress and egress and shall not be used. Use of elevators to access bicycle parking spaces shall be minimized for all uses and if necessary shall follow the requirements below. Bicycle parking shall be at least as conveniently located as the most convenient nondisabled car parking provided for the subject use. Residential buildings shall not use space in dwelling units, balconies or required private open space for required Class 1 bicycle parking. Class 1 bicycle parking can be stored within the allowable 100 square foot obstruction described in Section 136(c)(23) of this Code. Class 1 bicycle parking spaces shall be located:
 - (A) On the ground floor within 100 feet of the major entrance to the lobby. There shall be either:

- (i) convenient access to and from the street to the bicycle parking space and another entrance from the bicycle parking space to the lobby area, or
 - (ii) a minimum five foot wide hallway or lobby space that leads to the bicycle parking major entrance, where direct access to bicycle parking space from the street does not exist. Such access route may include up to two limited constriction points, such as doorways, provided that these constrictions are no narrower than three feet wide and extend for no more than one foot of distance.
 - (B) In the off-street automobile parking area, where lot configurations or other limitations do not allow bicycle parking spaces to be located near the lobby as described in subsection (A) above. Bicycle parking spaces shall be located on the first level of automobile parking either above or below grade and still be located near elevators or other pedestrian entrances to the building.
 - (C) One level above or below grade, where the two options above will not be possible due to an absence of automobile parking, small or unusual lot configurations, or other unique limitations. In such cases, ramps or elevators shall be provided to access the bicycle parking space and the bicycle parking spaces shall be near the elevators or other entrance to that story. At least one designated access route meeting the dimensional requirements described in (A) above shall connect a primary building entrance to the bicycle parking facility. For non-residential uses, any elevator necessary to access bicycle parking facilities larger than 50 spaces shall have clear passenger cab dimensions of at least 70 square feet and shall not be less than seven feet in any dimension.
- (2) Class 2 spaces shall be located, as feasible, near all main pedestrian entries to the uses to which they are accessory, and should not be located in or immediately adjacent to service, trash or loading areas. Further standards for specific uses include:
- (A) All uses, except non-accessory garages and parking lots, may locate Class 2 bicycle parking in a public right-of-way, such as on a sidewalk or in place of an on-street auto parking space, within 100 feet of a main entry to the subject building, subject to demonstration of preliminary approval by the necessary City agencies. If existing Class 2 bicycle parking in the required quantities already exists in a public right-of-way immediately fronting the subject lot, and such spaces are not satisfying bicycle parking requirements for another use, such parking shall be deemed to meet the Class 2 requirement for that use. Parking meters, poles, signs, or other street furniture shall not be used to satisfy Class 2 bicycle parking requirements, unless other public agencies have specifically designed and designated these structures for the parking of a bicycle.
 - (B) Non-residential uses other than non-accessory garages and parking lots, may locate Class 2 spaces in required non-residential open space (such as open space required by Sections 135.3 and 138 of this Code), provided that such bicycle parking does not occupy more than five percent of the open space area or 120 square feet, whichever is greater, and does not affect pedestrian circulation in the open space.
 - (C) Non-Accessory Garages and Parking Lots shall place Class 2 spaces within the garage in a location that will protect them from wind-driven rain near a primary entrance.
- (3) All Bicycle Parking Spaces.
- (A) Stadiums, Arenas, and Amphitheaters shall provide Class 1 bicycle parking for on-site Employees in a separate location from Class 2 parking provided as specified below:
 - (i) Such uses shall provide at least 75 percent but not more than 90 percent of Class 2 parking

in the form of an Attended Facility for patrons. The facilities shall continuously staff the Attended Facility and make it available to patrons of events from not later than one hour before the event begins to not earlier than one hour after the event finishes during all events with an expected attendance of greater than 2,000 people.

- (ii) Class 2 parking that is not provided in an Attended Facility per subsection (i) above shall be appropriately dispersed around the subject use in convenient and visible surrounding public spaces and rights-of-way within 500 feet of the perimeter of subject use.
- (B) Developments with multiple buildings shall disperse required bicycle parking, for both Class 1 and Class 2 spaces, in smaller facilities located close to primary occupant and visitor entries for each building, as appropriate, rather than in a large centralized facility serving the multiple buildings.
- (c) Design Standards for Bicycle Parking Spaces. These design standards apply to all bicycle parking spaces subject to Sections 155.2 and 155.3. Bicycle parking shall follow the design standards established in Zoning Administrator Bulletin No. 9, which includes specific requirements on bicycle parking layout and acceptable types of Class 1 and Class 2 bicycle parking spaces.
 - (1) Class 1 spaces shall protect the entire bicycle, its components and accessories against theft and inclement weather, including wind-driven rain. Acceptable forms of Class 1 spaces include (A) individual Lockers, (B) Attended Facilities, (C) Monitored Parking, (D) Restricted Access Parking, and (E) Stacked Parking, as defined in Section 155.1 and further detailed in Zoning Administrator Bulletin No. 9. When Class 1 spaces are provided as Restricted Access Parking, bicycle racks shall follow the specifications in subsection 2 below. Stacked Parking spaces may be used to satisfy any Class 1 required space. However, Class 1 spaces shall not require manually lifting the entire bicycle more than three inches to be placed in the space, except as provided in subsection (3) below for Vertical Bicycle Parking.
 - (2) Class 2 spaces shall meet the following design standards:
 - (A) Bicycle racks shall permit the locking of the bicycle frame and one wheel to the rack with a U-lock without removal of the wheel, and shall support the bicycle in a stable, upright position without damage to wheels, frame or components. Class 2 spaces are encouraged, but not required, to include weather protection, as feasible and appropriate.
 - (B) The surface of bicycle parking spaces need not be paved but shall be finished to avoid mud and dust.
 - (C) All bicycle racks shall be securely anchored to the ground or building structure, with tamper-resistant hardware.
 - (D) Bicycle parking spaces may not interfere with pedestrian circulation.
 - (3) Vertical Bicycle Parking. Vertical Bicycle Parking shall enable the bicycle to be locked to a rack or other object permanently affixed to a wall. Vertical Bicycle Parking may satisfy required bicycle parking pursuant to Section 155.2 and 155.3 where:
 - (A) Such parking is primarily an Attended Facility where facility staff parks the bicycles or such racks provide mechanical assistance for lifting the bicycle; or
 - (B) No more than one-third of the required Class 1 bicycle parking is provided as Vertical Bicycle Parking; or
 - (C) Class 2 spaces for Personal Services, Restaurants, Limited Restaurants, and Bars, as defined in Table 155.2(16) are provided either indoors or outdoors. In such cases, no more than one-

third of all required Class 2 bicycle parking shall be provided as Vertical Bicycle Parking. Class 2 bicycle parking for uses other than those defined in Table 155.2(16) shall not provide any of the required spaces as Vertical Bicycle Parking.

- (4) Signage Requirements for Bicycle Parking. Where Class 2 bicycle parking areas are not located in an outdoor location clearly visible to bicyclists approaching from adjacent public roadways or paths, signs shall indicate the locations of the facilities on the exterior of the building at each major entrance and in other appropriate locations. Such signs shall be not less than 12 inches square and shall use the template provided in Zoning Administrator Bulletin No. 9. Where necessary, additional directional signage to the bicycle parking area shall be provided.
- (d) Reduction of Auto Parking. When fulfilling bicycle parking requirements, the number of required automobile parking spaces on any lot may be reduced in the following cases per Section 150(e) of this Code:
- (1) Existing buildings subject to Section 155.2(a)(2) through 155.2(a)(5) or for City-owned properties subject to Section 155.3;
 - (2) Existing buildings not subject to any bicycle parking requirements; or
 - (3) New Buildings subject to Section 155.2(a)(1).

When replacing automobile parking space with bicycle parking, layout and design standards in Section 155.1(c) and the Zoning Administrator Bulletin No. 9 shall be followed.

- (e) Other Rules and Standards. This Section shall apply to all bicycle parking subject to Sections 155.2 or 155.3, except as indicated.
- (1) Except for non-accessory parking garages, bicycle parking required by Section 155.2 shall be provided at no cost or fee to building occupants, tenants and visitors.
 - (2) Required bicycle parking shall be provided on the subject lot except where alternative locations are allowed in Sections 155.2(e), 155.3(d), and 307(k) of this Code.
 - (3) The building, lot or garage may not establish unreasonable rules that interfere with the ability of cyclists to conveniently access bicycle parking. Such unreasonable rules include hours of operation and prohibitions on riding bicycles in areas where driving automobiles is permitted. The rules may require cyclists to walk bicycles through areas that are pedestrian only and where motorized vehicles are not permitted.
 - (4) All plans submitted to the Department containing bicycle parking intended to satisfy the requirements of Sections 155.2 and 155.3 shall indicate on said plans the location, dimensions, and type of bicycle parking facilities to be provided, including the model or design of racks to be installed and the dimensions of all aisle, hallways, or routes used to access the parking.
- (f) Effective Date. The effective date of the requirements for bicycle parking for different uses shall be the date that the Planning Code provisions pertaining to bicycle parking requirements for a particular use first became effective, or the date subsequent modifications to the requirements for that use, if any, became effective. The effective day for bicycle parking requirements for:
- (A) Commercial and industrial uses shall be either September 7, 2001, when Ordinance 193-01 became effective, or the date subsequent modifications, if any, to the bicycle parking requirements for commercial and industrial uses became effective.
 - (B) Residential uses shall be either August 19, 2005, when Ordinance 217-05 became effective, or the date subsequent modifications, if any, to the bicycle parking requirements for residential

uses became effective.

(C) Non-accessory parking garages shall be either November 19, 1998, when Ordinance 343-98 became effective, or the date a subsequent modification, if any, became effective.

(D) City-owned buildings, leased or purchased by the City shall be either January 11, 1996, when Ordinance 31-96 became effective, or the date a subsequent modification, if any, became effective.

(Added by Ord. 183-13 , File No. 130528, App. 8/7/2013, Eff. 9/6/2013)

(Former Sec. 155.1 added by Ord. 31-96, App. 1/11/96; amended by Ord. 343-98, App. 11/19/98; Ord. 187-09, File No. 090867, App. 8/12/2009; Ord. 173-12, File No. 120471, App. 8/2/2012, Eff. 9/1/2012; repealed by Ord. 183-13 , File No. 130528, App. 8/7/2013, Eff. 9/6/2013)

SEC. 155.2. BICYCLE PARKING: APPLICABILITY AND REQUIREMENTS FOR SPECIFIC USES.

Bicycle parking spaces are required in at least the minimum quantities specified in Table 155.2. Bicycle parking shall meet the standards in Section 155.1.

(a) Applicability. The requirements of this Section apply in all the following cases regardless of whether off-street automobile parking is available except if indicated:

- (1) New Building; or
- (2) addition of a dwelling unit to an existing building where off-street vehicle parking exists; or
- (3) addition to a building or lot that increases the building's gross floor area by more than 20 percent; or
- (4) change of occupancy or increase in intensity of use which would increase the number of total required bicycle parking spaces (inclusive of Class 1 and 2 spaces in aggregate) by 15 percent; or
- (5) where DBI determines that an addition or alteration meets the bicycle parking thresholds set in the State Law California Title 24, Part 11, Sec. 5.710.6.2; or
- (6) addition or creation of new gross square footage or an increase in the capacity of off-street vehicle parking spaces for an existing building or lot, regardless of whether such vehicle parking is considered accessory or a principally or conditionally permitted use.

(b) Rules for Calculating Bicycle Parking Requirements.

- (1) Under no circumstances may total bicycle parking provided for any use, building, or lot constitute less than five percent of the automobile parking spaces for the subject building, as required by the State Law California Title 24, Part 11, Sec. 5.710.6.2.
- (2) Calculations of bicycle parking requirements shall follow the rules of Section 153(a) of this Code.
- (3) Where bicycle parking is required per subsection (a)(2) above, bicycle parking shall be provided for all dwelling units at the same ratio as existing off-street vehicle parking is provided relative to the amount of off-street vehicle parking that is required by this Code.
- (4) Where bicycle parking is required due to addition, conversion, or renovation of an existing building, per subsection (a)(3) above, the bicycle parking shall be calculated based on the total square footage of the building or lot for all uses after the addition, conversion, renovation or parking expansion.
- (5) Where bicycle parking is required due to change of use, per subsection (a)(4) above, the bicycle

parking shall be calculated based on the occupied area of uses changed.

- (6) Where a project proposes to construct new non-residential uses or increase the area of existing non-residential uses, for which the project has not identified specific uses at the time of project approval by the Planning Department or Planning Commission, the project shall provide the amount of non-residential bicycle parking required for Retail Sales per Table 155.2 .

Table 155.2

BICYCLE PARKING SPACES REQUIRED

	Use	Minimum Number of Class 1 Spaces Required	Minimum Number of Class 2 Spaces Required
155.2.10	Dwelling Units (on lots with 3 units or less)	No racks required. Provide secure, weather protected space meeting dimensions set in Zoning Administrator Bulletin No. 9, one per unit, easily accessible to residents and not otherwise used for automobile parking or other purposes.	None.
.11	Dwelling units (including SRO units and student housing that are dwelling units)	One Class 1 space for every dwelling Unit. For buildings containing more than 100 dwelling units, 100 Class 1 spaces plus one Class 1 space for every four dwelling units over 100. Dwelling units that are also considered Student Housing per Section 102.36 shall provide 50 percent more spaces than would otherwise be required.	One per 20 units Dwelling units that are also considered Student Housing per Section 102.36 shall provide 50 percent more spaces than would otherwise be required.
.12	Group housing (including SRO units and student housing that are group housing)	One Class space for every four beds. For buildings containing over 100 beds, 25 Class 1 spaces plus one Class 1 space for every five beds over 100.	Minimum two spaces. Two Class 2 spaces for every 100 beds. Group housing that is also considered Student Housing per Section 102.36 shall provide 50 percent more spaces than would otherwise be required.
.13	Dwelling units dedicated to senior citizens or persons with physical disabilities; Residential Care facilities	One Class 1 space for every 10 units or beds, whichever is applicable.	Minimum two spaces. Two Class 2 spaces for every 50 units or beds, whichever is applicable.
.14	Offices	One Class 1 space for every 5,000 occupied square feet.	Minimum two spaces for any office use greater than 5,000 gross square feet, one Class 2 space for each additional 50,000 occupied square feet.

.15	Retail Sales, including grocery stores	One Class 1 space for every 7,500 square feet of occupied floor area.	Minimum two spaces. One Class 2 space for every 2,500 sq. ft. of occupied floor area. For uses larger than 50,000 gross square feet, 10 Class 2 spaces plus one Class 2 space for every additional 10,000 occupied square feet.
.16	Personal Services, Financial Services, Restaurants, Limited Restaurants and Bars	One Class 1 space for every 7,500 square feet of occupied floor area.	Minimum two spaces. One Class 2 space for every 750 square feet of occupied floor area.
.17	Retail space devoted to the handling of bulky merchandise such as motor vehicles, machinery or furniture, excluding grocery stores	Minimum two spaces. One Class 1 space for every 15,000 square feet of occupied floor area.	Minimum two spaces. One Class 2 space for every 10,000 square feet of occupied floor area.
.18	Post-secondary educational institution, including trade school	One Class 1 space for every 20,000 square feet of occupied floor area.	Minimum two spaces. One Class 2 space for every 10,000 square feet of occupied floor area.
.19	Elementary School	Two Class 1 spaces for every classroom.	One Class 2 space for every classroom.
.20	Secondary School (Middle School and High School)	Four Class 1 spaces for every classroom.	One Class 2 space for every classroom.
.21	Hospitals or In- patient Clinic	One Class 1 space for every 15,000 square feet of occupied floor area.	One Class 2 space for every 30,000 square feet of occupied floor area, but no less than four located near each public pedestrian entrance.
.22	Medical Offices or Out-patient Clinic	One Class 1 space for every 5,000 square feet of occupied floor area.	One Class 2 space for every 15,000 square feet of occupied floor area, but no less than four located near each public pedestrian entrance.
.23	Theaters, Assembly and Entertainment, Amusement Arcade, Bowling Alley, Religious Facility	Five Class 1 spaces for facilities with a capacity of less than 500 guests; 10 Class 1 spaces for facilities with capacity of greater than 500 guests.	One Class 2 space for every 500 seats or for every portion of each 50 person capacity.
.24	Stadium, Arena, Amphitheater or other venue of public gathering with a capacity of greater than 2,000 people	One Class 1 space for every 20 Employees during events.	Five percent of venue capacity, excluding Employees. A portion of these must be provided in Attended Facilities as described in Section 155.1(b)(3).

.25	Hotel, Motel, Hostel	One Class 1 space for every 30 rooms.	Minimum two spaces. One Class 2 space for every 30 rooms, – plus – One Class 2 space for every 5,000 square feet of occupied floor area of conference, meeting or function rooms.
.26	Self-Storage, Warehouse, Greenhouse or Nursery (Non-Retail)	One Class 1 space for every 40,000 sq. ft.	None.
.27	Light Manufacturing, Wholesale Sales, Trade Shop, Catering Service, Business Goods and Equipment Repair, Business Service, Laboratory, Integrated PDR, Small Enterprise Workspace, Greenhouse or Nursery (Retail)	One Class 1 space for every 12,000 square feet of occupied floor area, except not less than two Class 1 spaces for any use larger than 5,000 occupied square feet.	Minimum of two spaces. Four Class 2 spaces for any use larger than 50,000 gross square feet.
.28	Public Uses including Museum, Library, Community Center, and Arts Activities	Minimum two spaces or One Class 1 space for every 5,000 square feet.	Minimum two spaces or One Class 2 space for every 2,500 occupied square feet of publicly-accessible or exhibition area.
.29	Non-accessory automobile garage or lot, whether publicly or privately accessible	None are required. However, if Class 1 spaces that can be rented on an hourly basis are provided, they may count toward the garage's requirement for Class 2 spaces.	One Class 2 space for every 20 auto spaces, except in no case less than six Class 2 spaces.
.30	Child Care	Minimum two spaces or 1 space for every 20 children.	One Class 2 space for every 20 children.
.31	Mortuary	None.	None.

- (c) Contractual Limits on Liability. Requirements for non-accessory garages and parking lots subject to Table 155.2 (29) shall not interfere with the rights of a parking garage owner to enter into agreements with parking garage patrons or take other lawful measures to limit the parking garage owner's liability to patrons with respect to bicycles parked in the parking garage, provided that such agreements or measures are in accordance with the requirements of this subsection.
- (d) In Lieu Fee for Required Class 2 Bicycle Parking. An applicant may satisfy some or all of the requirements to provide Class 2 bicycle parking by paying the Bicycle Parking In Lieu Fee provided in Section 430 of this Code.

- (e) Alternative Locations, Waivers and Variances. The Zoning Administrator may administratively waive or grant a variance from bicycle parking requirements or approve alternative locations for bicycle parking under the procedures of Sections 305 and 307(k) of this Code.

(Added by Ord. 183-13 , File No. 130528, App. 8/7/2013, Eff. 9/6/2013)

(Former Sec. 155.2 added by Ord. 343-98, App. 11/19/98; repealed by Ord. 183-13 , File No. 130528, App. 8/7/2013, Eff. 9/6/2013)

SEC. 155.3. BICYCLE PARKING REQUIREMENTS FOR CITY-OWNED AND LEASED PROPERTIES.

- (a) Applicability. This Section applies to the installation of bicycle parking in existing buildings owned, leased or purchased by the City and City-owned non-accessory parking garages and parking lots.
- (b) Requirements. For all City-owned or leased buildings, non-accessory garages, and parking lots, regardless of whether off-street vehicle parking is available, the Responsible City Official, as defined in Section 155.1, shall provide bicycle parking according to the use categories specified in Table 155.2. All required bicycle parking provided per this Section shall conform to the standards of Sections 155.1 and 155.2. The provisions of this Section shall not apply in any case where the City occupies property as a tenant under a lease, the term of which does not exceed one year.

(c) Lease Provisions.

- (1) Lease provisions apply to all City leases for buildings that are subject to the requirements of subsection 155.3 and under which the City is a tenant. Such leases shall specifically provide that the Landlord agrees to make space available in the building for bicycle parking facilities. These facilities shall be available for the term of the lease. These leases shall also provide that the Responsible City Official may install, at no cost to the Landlord bicycle parking facilities that are in compliance with subsection (b).
 - (2) This subsection (c) does not in any way limit the ability of the Zoning Administrator to approve alternative locations for bicycle parking under provision of Section 307(k). In the event that an exemption is granted or an alternative location is approved allowing the installation of bicycle parking facilities on property that is not included in a building leased by the Responsible City Official, or on property that belongs to the Landlord subsection (c) does not apply. If the alternative location is on property that is owned by the Landlord, but is not inside the building to be leased by the Responsible City Official, the lease provision of subsection (c) is required and shall identify that property as the location of the bicycle parking facility.
- (d) Alternative Locations, Reductions or Exemptions. In the event that compliance with Section 155.3(b) for Class 1 bicycle parking may not be feasible because of demonstrable hardship including but not limited to absence of an off-street automobile garage on the subject lot, the Responsible City Official may apply to the Zoning Administrator under the procedures of Section 307(k)(1) for approval of an alternative storage location, reduction or exemption from the requirements. Waivers and Variances for Class 2 bicycle parking required by subsection (b) above would be subject to the same measures as Section 307(k)(2).
- (e) Implementation. Except as provided in subsection (g)(2), all City-owned buildings and parking garages subject to Section 155.3 shall comply and install the required bicycle parking and associated signage within one year of the effective date of this Ordinance No. 183-13 .
- (1) Where this Section imposes requirements on the City, the Responsible City Official shall be responsible for fulfilling such requirements.
 - (2) If during the one-year implementation period set forth in subsection (e) the demand for the bicycle parking facilities is less than 80 percent of the spaces within 20 consecutive non-holiday

weekdays, the parking garage may apply to the Zoning Administrator under the procedures of Section 307(k)(1)(B) for permission to delay full compliance with subsection (b). In the case of a parking garage that is not predominantly used during the regular work week (for example, a parking garage near an event venue), the Zoning Administrator may designate an alternative period other than “non-holiday weekdays” for purposes of evaluating an exemption from the full requirements of subsection (b). Such alternative period may include, but not be limited to, 10 consecutive weekends or 20 days on which the parking garage primarily serves customers attending an event at a nearby venue.

(3) Except as provided in subsection (g)(2), existing City-owned buildings and garages with existing substandard racks, which do not comply with acceptable rack types defined in 155.1(c), shall have one year from the effective date of this Section to replace them with conforming racks.

(j) **Monitoring.** The Planning Department shall, every five years, beginning with 2013, survey the amount, location, and usage of both Class 1 and Class 2 bicycle parking spaces at (A) City Hall, (B) the Main Library, (C) the 25 other City-owned or leased buildings which have the highest square footage as identified in a list published by the City’s Department of Real Estate, and (D) City-owned garages in order to report compliance with this Section and to ascertain whether current requirements are adequate to meet demand for such parking spaces. Such survey of usage shall be conducted during the months of March through October and shall document usage on at least two fair-weather non-holiday week days. A report on such findings shall be submitted to the Planning Commission and the San Francisco Municipal Transportation Agency Board of Directors. If current requirements are inadequate, the Director shall draft and submit to the Board of Supervisors proposed legislation that would remedy the deficiency. For the purposes of this subsection, “inadequate” shall mean an occupancy of greater than 85 percent or in cases where bicycles are clearly parked in non-standard locations due to crowding of the provided facilities.

(g) **Miscellaneous Standards and Requirements.**

(1) In any City-owned or leased building, non-accessory parking garage, or parking lot that contains more than the required number of bicycle parking spaces as set forth above, the Responsible City Official or private parking garage owner shall not remove such additional bicycle parking spaces without petitioning the Zoning Administrator. Such a petition may not be filed until at least one year after the effective date of this Section. That petition shall demonstrate that the spaces the Responsible City Official or private parking garage owner seeks authority to remove have not been necessary to meet the demand of Employees and other building users.

(2) For existing buildings owned, leased or purchased by the City and City-owned parking garages, the Responsible City Official shall comply with this Section 155.3. The Board of Supervisors does not intend to impose requirements of this Section on any Responsible City Official where such application would impair obligations of contract.

(Added by Ord. 183-13 , File No. 130528, App. 8/7/2013, Eff. 9/6/2013)

(Former Sec. 155.3 added by Ord. 343-98, App. 11/19/98; repealed by Ord. 183-13 , File No. 130528, App. 8/7/2013, Eff. 9/6/2013)

A.3 San Francisco Tenant Bicycle Parking in Existing Commercial Buildings Ordinance

The San Francisco Board of Supervisors passed the [San Francisco Tenant Bicycle Parking in Existing Commercial Buildings Ordinance](#) in 2012. This bill requires owners of commercial buildings to either provide secure bicycle parking in buildings or within 750 feet of the entrance, otherwise property owners/managers must allow tenants to bring their bicycles into the building unless they apply for an exception. This legislation does not require building owners to build a bicycle room or dedicate a specific space for bicycle parking but allows commercial tenant employees to bring their bicycles inside rented space if a separate and secure storage area is not available.

Full Document: [SF Tenant Bicycle Parking in Existing Commercial Buildings](#)

[http://www.amlegal.com/nxt/gateway.dll/California/environment/chapter4healthyairandcleantransportation?f=templates\\$fn=default.htm\\$3.0\\$vid=amlegal:sanfrancisco_ca\\$sanc=JD_402](http://www.amlegal.com/nxt/gateway.dll/California/environment/chapter4healthyairandcleantransportation?f=templates$fn=default.htm$3.0$vid=amlegal:sanfrancisco_ca$sanc=JD_402)

A.4 Transportation Code Section 909

Section 909 of the San Francisco Transportation Code describes issuance of bicycle rack permits, criteria for granting a permit, placement of a rack, and coordination with the Department of Public Works. Note, however, that in practice, the SFMTA does not grant private permits to property owners to install racks. Rather, property owners who want something other than the City's standard rack may gift racks to the SFMTA for installation (See Chapter 6).

The full text of Section 909 is as follows:

- a. Issuance of Bicycle Rack or Bicycle Sharing Station Permits.** The Director of Transportation has the authority at his or her sole discretion to grant a revocable permit to the property owner of property abutting any Street of the City to install and maintain a bicycle rack on the sidewalk fronting such property, or to the operator of a bicycle sharing program to install and maintain a bicycle sharing station on the sidewalk or any Street of the City. The Director of Transportation may impose permit conditions related to the installation, design, location or maintenance of the bicycle rack or bicycle sharing station as he or she determines necessary to protect the public convenience and safety. No permit for a bicycle rack issued under this Section 909 shall become effective until the permit has been signed by the Permittee or the Permittee's authorized agent and a copy of the permit has been recorded in the office of the City Recorder.
- b. Criteria for Granting a Bicycle Rack or Bicycle Sharing Station Permit.** In considering an application for a bicycle rack or bicycle sharing station permit, the Director of Transportation shall consider the proposed location and design of the bicycle rack or bicycle sharing station in light of all legal requirements, the availability of Parking, and the anticipated effects of the proposed bike rack or bicycle sharing station on public transit, pedestrian and vehicular traffic and access to or from residences and businesses.
- c. Placement of Bicycle Rack or Bicycle Sharing Station.** The Director of Transportation may at his or her own initiative and after giving notice to the abutting property owner(s) cause bicycle racks or bicycle sharing stations to be installed on any Street or sidewalk of the City.

A.5 Better Streets Plan Section 6.5: Site Furnishings

Site furnishings consist of all other streetscape facilities and amenities in the sidewalk, including: benches and seating, bicycle racks, bollards, flowerstands, kiosks and gateway monuments, newsracks, parking meters, public art, sidewalk restrooms, traffic and parking signs, trash receptacles, and wayfinding signage. Generally, site furnishings should be located in the furnishings zone of the sidewalk. Site furnishings should be considered design elements, and use consistent, aesthetic design along a particular street or corridor. They should also meet basic clearances and requirements for accessibility, maintenance, and safety.

Full Document: http://www.sf-planning.org/ftp/BetterStreets/docs/FINAL_6_Streetscape_Elements.pdf

A.6 Other Relevant Policies

SFMTA Mode Share Goals

The 2013-2018 SFMTA Strategic Plan set a mode share target of 50 percent of all trips by sustainable modes (walking, bicycle, public transit, and vehicle sharing). Strategic Plan Goal 2 is to make transit, walking, bicycling, taxi, ridesharing, and car sharing the preferred means of travel. In pursuit of these goals, the SFMTA is implementing bicycle programs and infrastructure, including bicycle parking.

San Francisco Bicycle Plan

The 2009 San Francisco Bicycle Plan's Chapter 2 is dedicated to information about bicycle parking; the goal of the chapter is to "Ensure Plentiful, High-Quality Bicycle Parking" and the objectives are to:

- Provide secure short-term and long-term bicycle parking, including program support for bicycle stations and attended bicycle parking facilities at major events and destinations
- Provide current and relevant information to bicyclists regarding bicycle parking opportunities through a variety of formats.

The Plan also includes a series of 15 action policies for implementing bicycle parking that these Guidelines help fulfill. These include:

- Working with other city partners,
- Pursuing bicycle parking in public and private buildings of various land uses,
- Training city staff about bicycle parking,
- A review of bicycle parking types,
- General guidelines for placement, and
- Information about bicycle parking outreach, and bicycle parking at events

Climate Action Plan

The SFMTA Climate Action Strategy proposes six interdependent strategies to substantially reduce citywide transportation carbon emissions. These strategies include transportation sector policies and programs needed to meet the City's greenhouse gas reduction goal of 80 percent below 1990 levels by 2050. One of the strategies for achieving these reductions is implementing Complete Streets, including an increase in bicycle parking capacity citywide.

San Francisco Police Code Article 1: PUBLIC NUISANCES

The provisions of Section 63(e) of this Article shall not apply to:

Bicycle racks or motorcycle racks placed upon the sidewalks by permission of the Director of Public Works and of the adjoining property owners for the accommodation of persons using such bicycle or motorcycle, the same not to exceed three feet in width and three feet in height and to be entirely devoid of advertising matter; provided, that motorcycle racks shall be supplied with a metallic pan for the purpose of catching oil drippings.

(Amended by Ord. 523-83, App. 11/4/83)

California Vehicle Code

Bicycle Parking

21210. No person shall leave a bicycle lying on its side on any sidewalk, or shall park a bicycle on a sidewalk in any other position, so that there is not an adequate path for pedestrian traffic. Local authorities may, by ordinance or resolution, prohibit bicycle parking in designated areas of the public highway, provided that appropriate signs are erected.

Added Ch. 751, Stats. 1976. Effective January 1, 1977.

Appendix B: Bicycle Rack Gift Agreement



SFMTA.COM

The San Francisco Municipal Transportation Agency (SFMTA) accepts the gift of ____ bicycle racks from _____. Bicycle racks which are available to the public offer people travelling by bicycle the opportunity to store their bicycle temporarily in a secure and orderly manner. Both the private party gifting the bicycle rack(s) and the SFMTA understand that the SFMTA will install the bicycle rack(s) in the public right-of-way, not on private property. The parties further agree that the bicycle racks shall be used for the sole purpose of providing bicycle parking to members of the public. Like all bicycle racks in the public right-of-way, the bicycle rack(s) are to be used on a first-come first-serve basis by any member of the public.

The design and construction of the gifted rack(s) must comply with the SFMTA Bicycle Parking Guidelines and is subject to prior approval by SFMTA bike parking program staff. By signing this Agreement, the bicycle rack donor and the SFMTA confirm that the bicycle rack design meets SFMTA guidelines and the SFMTA accepts the gift.

With SFMTA acceptance of the gift, staff will coordinate with the donor for delivery to the SFMTA sign shop. Upon delivery of the bicycle rack(s), installation will be the responsibility of the SFMTA. The SFMTA will consider suggested installation location(s) for the bicycle rack(s), but ultimately, it is the responsibility of the SFMTA to determine the appropriate location(s) for installation in the public right-of-way, consistent with the Agency’s guidelines and considering site conditions. The SFMTA makes no specific promises as to a timeline for installation but will attempt to place racks without undue delay. If donated bicycle rack(s) falls into disrepair, is not maintained or is deemed unusable for the purposes intended, the SFMTA reserves the right to remove the bicycle rack(s), and may, in its sole discretion, replace them with the City’s standard racks. The SFMTA assumes no responsibility for returning a donated bicycle rack(s) that has been removed.

The City retains the absolute right to alter, repair, modify, remove, relocate, sell, dispose of, distort, or destroy any bicycle rack donated to the City for any reason.

Donated by:

Company Name	
Contact Person	
Street Address	
Phone Number	
Email Address	
Number of Racks	
Total Value of Gift	
Signature	
Date	

Accepted by:

Director of Transportation	Edward D. Reiskin
Signature	
Date	



ZONING ADMINISTRATOR BULLETIN NO. 9

Bicycle Parking Requirements: Design and Layout

Section 307 of the Planning Code mandates the Zoning Administrator to issue and adopt such rules, regulations and interpretations as are in the Zoning Administrator's opinion, necessary to administer and enforce the provisions of the Planning Code.

Date:
August 2013

Relevant Code Sections:

Section 155.1 *Bicycle Parking Definitions and Standards*

Section 155.2 *Bicycle Parking Applicability and Requirements for Specific Uses*

Section 155.3 *Bicycle Parking Required for City-Owned Properties*

Section 155.4 *Shower Facilities and Lockers*

PURPOSE:

Sections 155.1 through 155.3 of the Planning Code regulate bicycle parking requirements. This bulletin specifically regulates design and layout requirements for Class One and Class Two bicycle parking spaces.

RULING:

The San Francisco Planning Department has adopted and shall implement the following standards for bicycle parking.

TYPES OF BICYCLE PARKING

The Planning Code requires two types of bicycle parking defined in Section 155.1(a): 1) Class One spaces are "spaces in secure, weather-protected facilities intended for use as long-term, overnight, and work-day bicycle storage by dwelling unit residents, non-residential occupants, and Employees"; and 2) Class Two spaces are "spaces located in a publicly-accessible, highly visible location intended for transient or short-term use by visitors, guests, and patrons to the building or use."

Bicycle parking spaces are generally in the form of lockers or racks. Bicycle lockers can be used to satisfy the requirements for Class One bicycle parking and bicycle racks can be used to satisfy the requirements for Class Two bicycle parking. When located in a locked area or attended facility, bicycle racks can also satisfy the requirements for Class One bicycle parking.

BICYCLE DIMENSIONS

Standard dimensions for a typical bicycle are 2 feet wide by 6 feet long. All bicycle lockers or racks shall provide a 2 feet by 6 feet space, unless specified in this bulletin for certain types of bicycle racks and lockers. Any type of bicycle parking that does not match the requirements of this bulletin must be approved by the Zoning Administrator (in consultation with the SFMTA) for determination of equivalency.

Class One Bicycle Parking

Class One bicycle parking includes bicycle lockers, bicycle rooms or cages where each bicycle can be individually locked. Bicycle lockers provide secure space with a separate access door for every bicycle. Lockers shall provide a minimum depth of 6 feet and an access door of 2 feet wide when providing space for one bicycle. Some lockers divide the space into two triangular shaped spaces. Such lockers shall provide a slightly larger space as shown in the figure below.

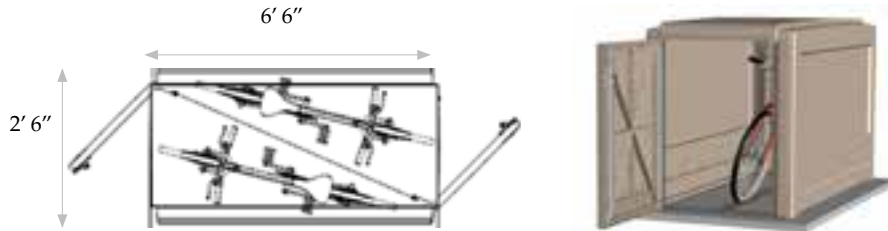

All aisles that provide access to a locker shall be minimum of 6 feet wide.

Where Class One bicycle parking is provided as bicycle racks in a garage, cage or otherwise locked room, any acceptable rack type, including space efficient racks, identified in this bulletin may be used. Required clearances for rows of racks provided in such facilities are described later in this Bulletin.

Class Two Bicycle Parking

Bicycle racks are the most common form of Class Two bicycle parking. Bicycle racks come in many forms and shapes. The most common types are the inverted “U” and the circular racks. The dimensions of such racks are shown here. Each rack that comply with dimensions and requirements set forth in this bulletin will count as two bicycle parking spaces.

All bicycle racks shall:

- support bicycles at two points of contact in order to prevent bicycles from falling;
- allow locking of bicycle frames and one wheel with U-locks;
- use square tubes to resist illegal rack cutting;
- minimize maintenance costs (i.e. galvanized finish resists corrosion);
- not require lifting of a bicycle;
- be mounted securely to the floor; and
- provide visibility to approaching cyclists and pedestrians with a minimum height of 32 inches.

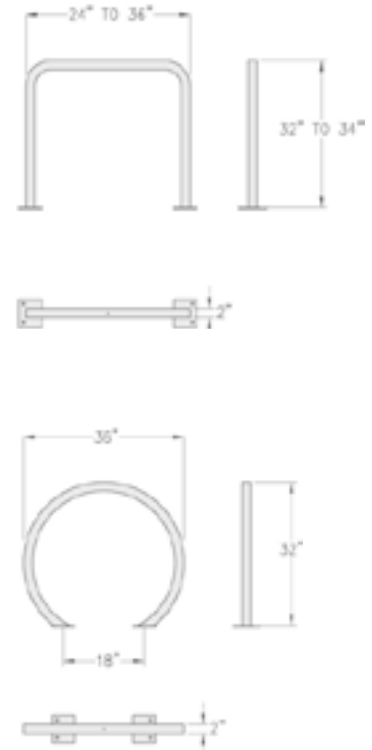

Some acceptable and unacceptable types of bicycle racks are shown below:



Acceptable
These bicycle racks provide two points of support for bicycles. They are constructed with square tubed material which makes the racks resistant to cutting.



Unacceptable
These bicycle racks either provide only one point of support for bicycles, are constructed with round tubed material which makes them prone to cutting, or do not allow locking a frame and wheel directly to the rack with a U-lock.

Alternative bicycle rack types that are not shown here may be considered upon review. For example, some bicycle racks do not provide two points of contact but would secure a bicycle against being knocked over by holding the front wheel stationary, provide an additional point of contact, and allow standard U-locks to lock the frame with a wheel to the rack. Use of such racks must be approved by the Zoning Administrator (in consultation with the SFMTA) for determination of equivalency.

CLEARANCE REQUIREMENTS FOR BICYCLE RACKS

I. Clearance from a vertical obstruction (wall, curb, bollards) for parallel and perpendicular racks

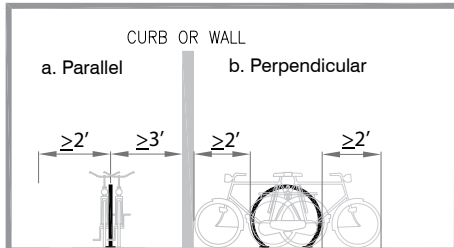

- a. When placed parallel to a wall, a rack must be at least three feet away from any vertical obstruction. If the bicycle rack is only two feet away, such rack would only satisfy one required bicycle parking space.
- b. When placed perpendicular to a wall, the rack must be at least two feet and preferably three feet away from the vertical obstruction. A standard bicycle sticks out about two feet from a standard inverted U or circular rack.

II. Minimum Vertical Clearance

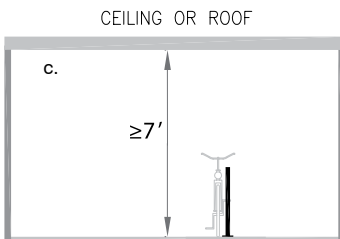

- c. Bicycle racks must be located in areas with at least seven feet of clearance between the ground and the ceiling or any elevated obstruction. Bicycle racks also should be installed on surfaces with minimal slopes, preferably as close to 0% grade as possible.

III. Layout of racks perpendicular to the aisles

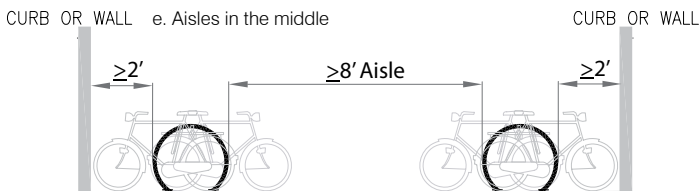
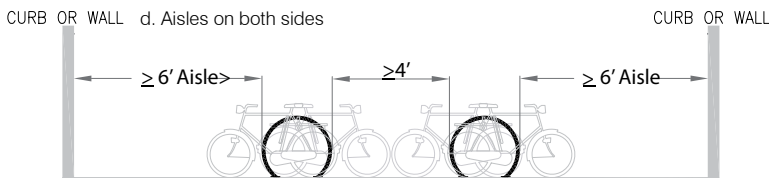

IV. Layout of racks parallel to the aisles

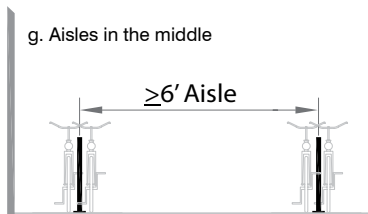
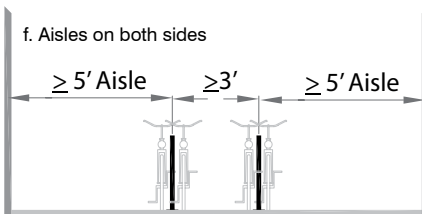

In cases shown in illustration (g) racks must be at least three feet from the wall to allow two bikes parked to one rack. If this distance is lower than three feet, such rack would only count for one bicycle parking space.

Illustration (d) through (g)- An aisle is the space used to provide access for bicycles in and out of the racks. Aisles may be provided on both sides of the rack as shown in Illustrations (d) and (f) or in the middle of racks as shown in Illustrations (e) and (g).

A four feet continuous clear space for pedestrian circulation - from the front a bike on one side to the front of the bike on the other side- must be maintained in all aisles. Each bicycle rack shall have at least one such aisle on its side.

Illustration (d) & (e)- When racks are placed perpendicular to the aisles (III), a standard parked bicycle sticks out of the rack and intrudes into the aisle space about two feet. Therefore, in order to maintain the four feet wide pedestrian circulation, the aisles must be at least 6 feet wide when placed on the sides (d), and at least 8 feet wide when placed in the middle (e). The recommended aisle width for these cases are 8 feet and 10 feet respectively.

Illustration (f) & (g)-When racks are placed parallel to the aisles, each parked bicycle in the aisle zone consumes about one foot of the aisle width. In order to maintain the four feet wide pedestrian circulation space, the aisles must be at least 5 feet wide when placed on the sides (f), and 6 feet wide when placed in the middle (g). The recommended aisle width for these cases are 7 feet and 8 feet respectively.

h. An example of a layout where racks are perpendicular to the aisles and aisles placed between rows of racks

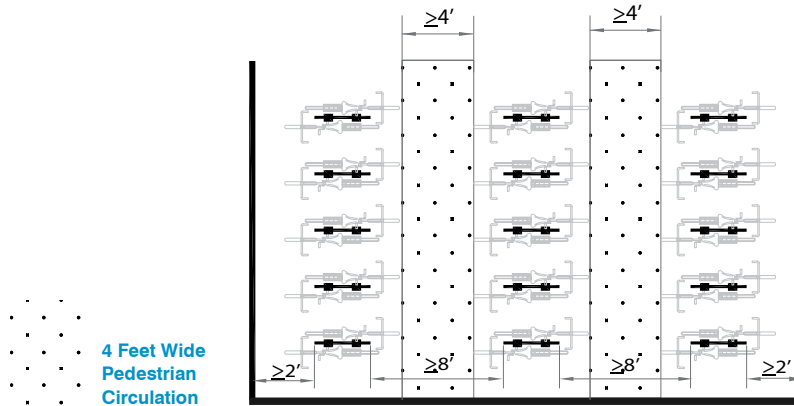

CONVERTING AUTOMOBILE PARKING TO BICYCLE PARKING

Section 151 of the Planning Code allows replacement of required off-street automobile parking spaces with bicycle parking in order to satisfy the bicycle parking requirements.

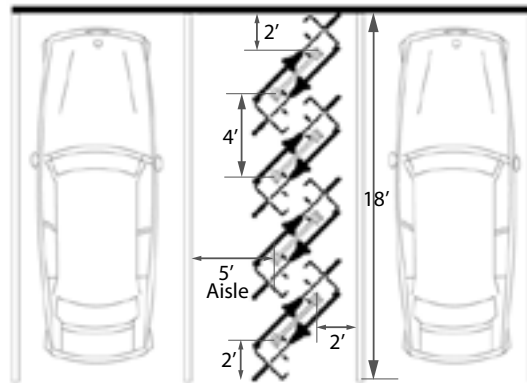

i. Shown here is a potential design to convert one car parking space into eight bicycle parking spaces by installing four inverted U style bicycle racks. This space must be separated from the adjacent car parking spaces with bollards or other physical dividers. If dividers are not provided, the distance between racks and the nearest stripe of car parking space must be at least three feet (increased from two feet shown in the diagram) and the aisle space must be 6 feet (increased from five feet shown in the diagram).

ACCESS ROUTES AND ALLOWED CONSTRICTIONS

Section 151.1(b)(1)(A) of the Planning Code regulates the access routes to and from bicycle parking facilities. Where direct access to the bicycle parking from the street is not provided, this Section requires "a minimum five foot wide hallway or lobby space that leads to the bicycle parking major entrance." It also establishes that "such access route may include up to two limited constriction points such as doorways, provided that these constrictions are no narrower than three feet wide and extend for no more than one foot of distance."

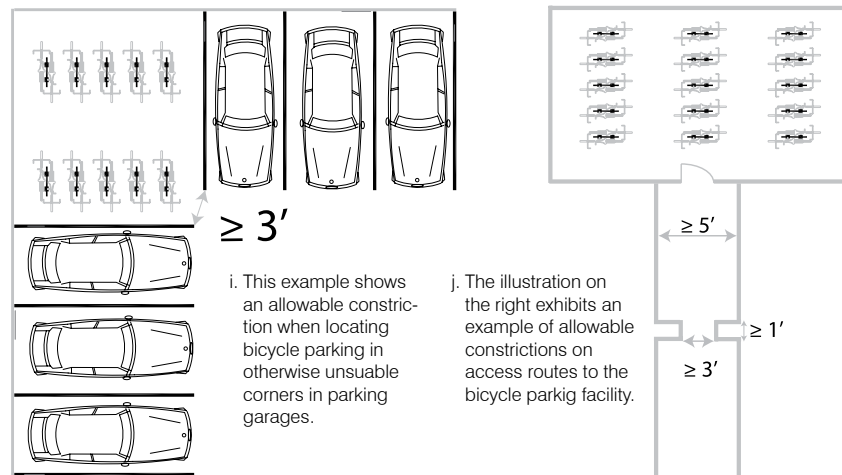

SPACE EFFICIENT BICYCLE PARKING

Some types of bicycle racks, while not meeting the clearance requirements established above, are designed in a way that would meet the basic requirements of an appropriate bicycle rack. Such racks provide a more space efficient layout which can serve smaller buildings; or where layout limitations exist. In no case shall a bicycle parking space require lifting the bicycle's both wheels more than 12" off the ground. Two types of such racks include lift-assist double-decker racks and vertical racks. Below, the minimum spacing measurements of such designs are provided. Any type of bicycle parking that does not match the requirements of this bulletin must be approved by the Zoning Administrator (in consultation with the SFMTA) for determination of equivalency.

Double-Decker Lift-Assist Racks

These bicycle racks allow stacking of bicycles providing a lift-assist pull-out tray. Manual lifting of bicycles off the ground is not necessary to mount the bicycle on the top trays. These racks satisfy the Class One bicycle parking requirements when located in a caged or locked facility. The trays alternate in height off the ground which allows a smaller required clearance between bicycles (17"), measured from mid-point of one rack to mid-point of other rack. The required aisle space is 5 feet and is measured from the nearest edge of bicycles and racks as shown below.

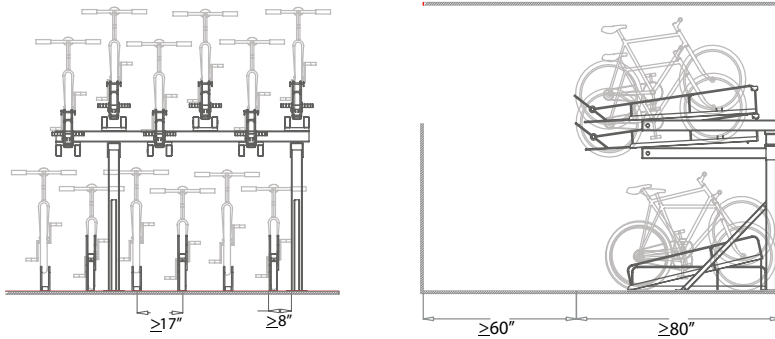

Vertical Bicycle Racks

These bicycle racks allow parking bicycles in a vertical position. This type of rack require manual lifting of bicycles in order to mount to the rack. Vertical bicycle parking may satisfy up to only a third of required bicycle parking per Planning Code Section 155.1(c). A minimum 16" of distance between racks are required to allow for easy mounting which is measured from the mid-point of one rack to the mid-point of another rack. The required aisle space is 5 feet and is measured from the outer edge of bicycles as shown below.

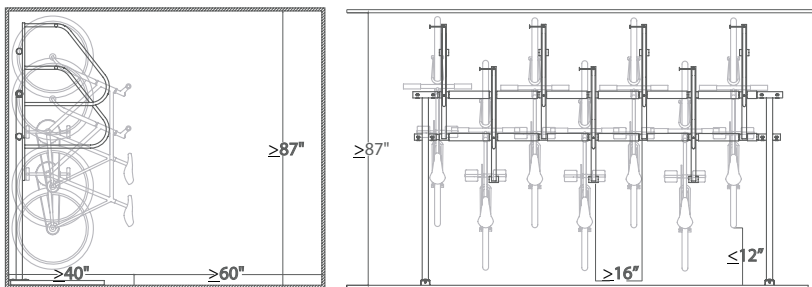
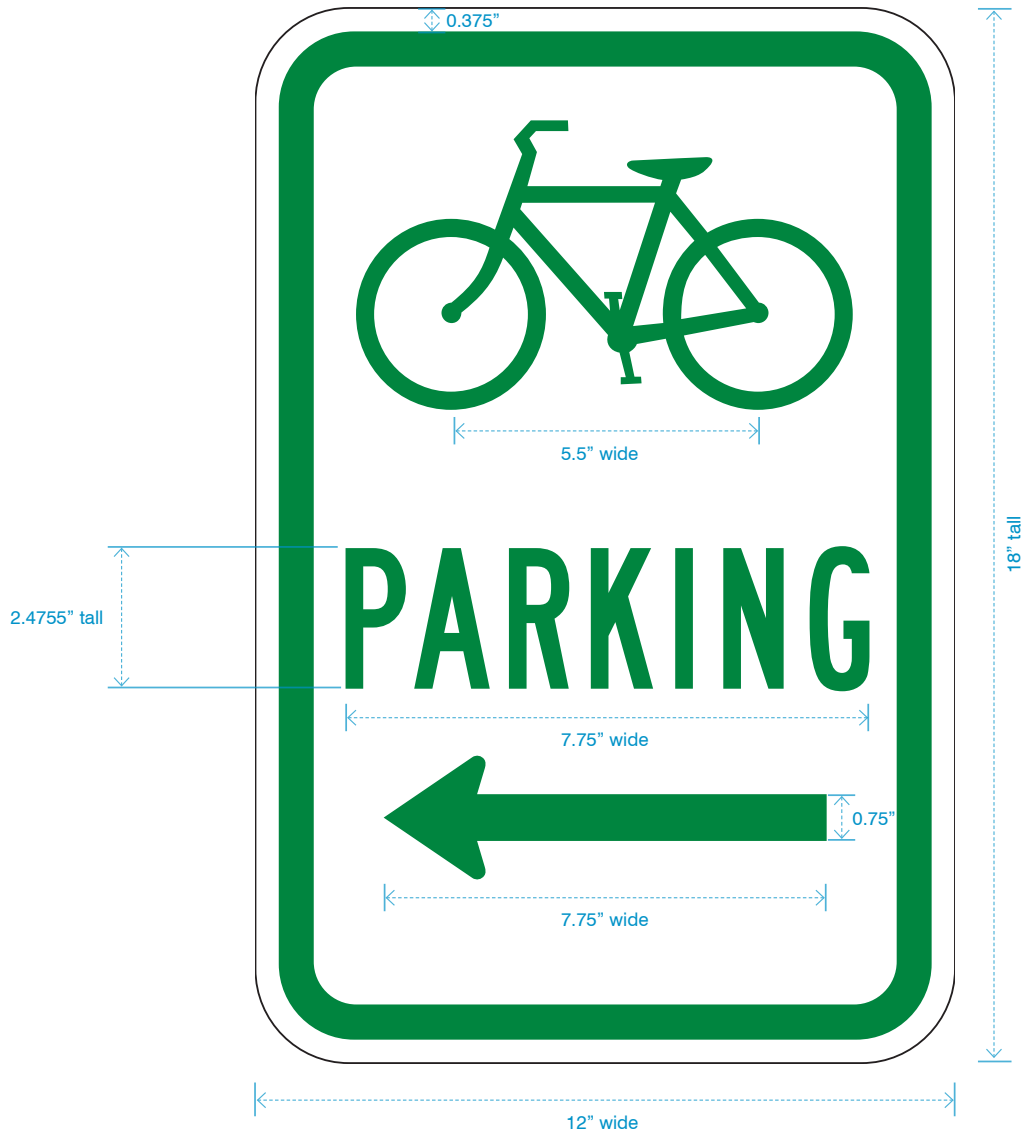

Figure 1
MUTCD D4-3 Bicycle Parking Sign Template and Dimen-



NOTE:

All signs are required to be 12" wide x 18" high, as set forth in the artwork template, and may not be modified.

The D4-3 Bicycle Parking Sign may not be modified.

This template is available on-line at: <http://bikerparking.sfplanning.org>

Figure 2
Bicycle Parking Specific Location Sign Template and Dimensions



NOTE:

All signs are required to be 12" wide x 180" high, as set forth in the artwork template, and may not be modified. The location information font size should 100 point and may not be modified.

This template is available on-line at: <http://xx.sfplanning.org>

Figure 3
Bicycle Parking Facility Maintenance Sign Template and Dimensions



NOTE:

All signs are required to be 12" wide x 18" high, as set forth in the artwork template, and may not be modified. The facility maintenance contact information font size should 80 point and may not be modified.

This template is available on-line at: <http://xx.splanning.org>



CITY AND COUNTY OF SAN FRANCISCO MUNICIPAL TRANSPORTATION AGENCY (SFMTA) STANDARD BICYCLE RACK SPECIFICATIONS

- Shape:** Circular Rack (see diagram at end)
- Rack Material:** **Hoop:** 2" x 2" by 0.188" wall square tube
Reference: ASTM A500 Standard Specification for Welded and Seamless Carbon Steel Structural Tubing in Rounds and Shapes
- Flanges:** Two 5" x 6" (five inches by six inches) flanges, 3/8" thick plate; with three 9/16" mounting holes on each flange
- Rack Coating:** Zinc Coated (Hot-Dip Galvanized)
Reference: ASTM A-123 Standard Specifications for Zinc (Hot-Dip Galvanized) Coatings on Iron and Steel Products
- Dimensions:** **Rack Width:** 36" (to outside dimensions)
- Distance Between Flanges (center to center):** 18"
- Height:** 32"
- Alignment:** Hoop shall be laterally aligned within a range of tolerance of 1" (e.g.: when hoop is laid flat, no part of the underside of the rack, excepting flanges, will rise higher than 1" off of flat surface).
- Please see diagram at end for additional information.
- Mounting:** Surface Mount
- Fasteners:** Per bike rack:
- Two 0.5" x 2.75" Powers Spike® Pin Anchor Mushroom Head Spike (Catalog Number 5569) or approved equal, and
 - Four 0.5" x 3.75" Powers Power-Stud™ Wedge Expansion Anchor Threaded Power-Stud Assembly (Catalog Number 7422) or approved equal

Fasteners shall be zinc plated carbon steel

Edwin M. Lee
Mayor

Tom Nolan
Chairman

Cheryl Brinkman
Vice-Chairman

Leona Bridges
Director

Malcolm Heinicke
Director

Jerry Lee
Director

Joél Ramos
Director

Cristina Rubke
Director

Edward D. Reiskin
Director of Transportation

One South Van Ness Ave.
Seventh Floor
San Francisco, CA 94103

Tele: 415.701.4500

www.sfmta.com



Welding: American Welding Society D1.1 Structural Welding Code Steel.

All welding shall be done by experienced and qualified welders in accordance with the standards and requirements of AWS D1.1. The Successful Contractor or manufacturer shall provide suitable means for clamping and holding members during the welding in order that warping or distortion of the structure shall be minimized. All welds shall have a 1/4-inch extra length at each end to allow for craters. Particular care shall be exercised to prevent undercutting or reducing the section of the material being welded. Grind exposed welds smooth.

Fabrication: Fabricate all steel for bicycle racks in accordance with the requirements of the Specifications. Identify all steel at the mill showing grade and yield points. Fabricate and assemble the steel segments in the shop to the greatest sizes possible without detriment to handling, transporting and erection in the field.

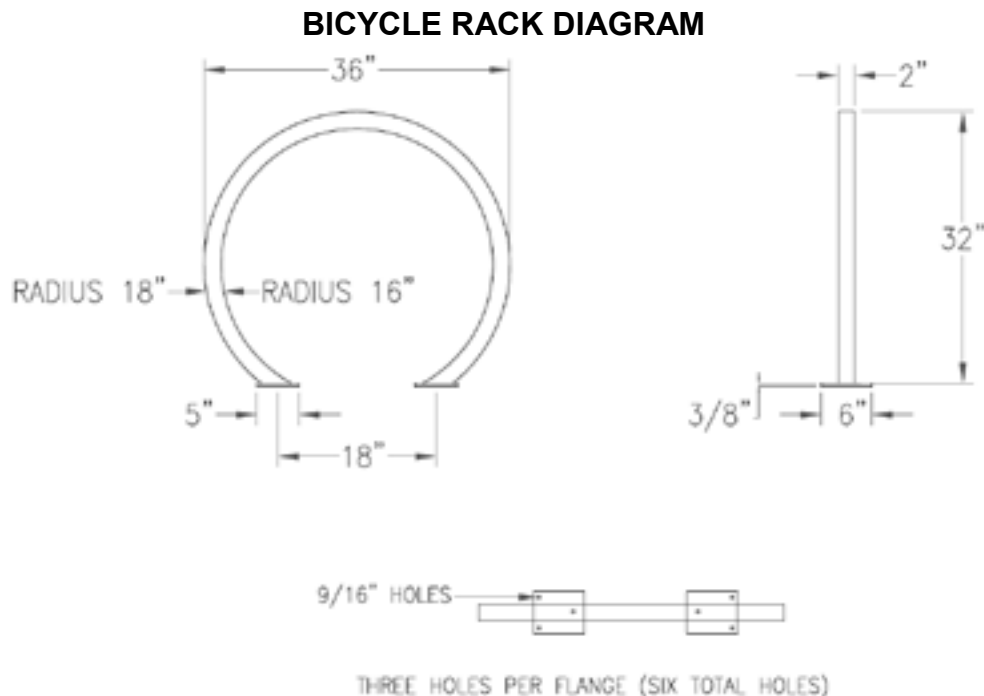

Appendix E: Select Bicycle Parking Vendors

E.1. Lockers

Belson Outdoors
www.belson.com

Creative Pipe
www.creativepipe.com

CycleSafe
www.cyclesafe.com

Dero Bicycle Racks
www.dero.com

eLock Technologies
www.elocktech.com

E.2. Racks

Belson Outdoors
www.belson.com

Bicycle Rack Source
www.bicycleracksource.com

Creative Pipe
www.creativepipe.com

CycleSafe
www.cyclesafe.com

Dero Bicycle Racks
www.dero.com

Palmer Group
www.bikeparking.com

Saris
www.saris.com/commercial-parking.html

The Park
www.theparkcatalog.com

Urban Racks
www.urbanracks.com/



SFMTA
Municipal
Transportation
Agency

SFMTA Bicycle Program

One South Van Ness Avenue
San Francisco, CA 94103

415.701.4500 or call 311
www.sfmta.com/bike
sustainable.streets@sfmta.com

Updated: December 3, 2015

Created: November 18, 2011