

City and County of San Francisco



# Regulations for Working in San Francisco Streets



Revised September 26, 2024

## **PARKING AND TRAFFIC REGULATIONS FOR WORKING IN SAN FRANCISCO STREETS (“THE BLUE BOOK”)**

This manual serves as a guide for working in San Francisco streets. Parties working in San Francisco streets are hereinafter referred to collectively as “Contractor” or “Applicant.”

This manual establishes rules and guidance so that work can be done both safely and with the least possible interference with pedestrians, bicycle, transit and vehicular traffic. All traffic control, warning and guidance devices must conform to the California Manual on Uniform Traffic Control Devices (MUTCD). In addition to the regulations in this manual, Contractor is responsible for complying with all applicable city, state, and federal codes, rules and regulations. This manual also contains relevant general information, contact information, and procedures related to working in the public right of way controlled by agencies other than the San Francisco Municipal Transportation Agency (SFMTA).

The party responsible for setting up traffic control shall be held accountable and responsible if traffic control does not meet the guidance and requirements established by this manual and state requirement.

The authority for establishing the Blue Book is derived from the [San Francisco Transportation Code](#).

Prepared by:  
San Francisco Municipal Transportation Agency  
Streets Division  
San Francisco, California

**Revised September 26, 2024**

This free manual can be obtained from, free of charge at:  
San Francisco Municipal Transportation Agency, Streets Division,  
1 South Van Ness Avenue, 7<sup>th</sup> Floor, San Francisco, CA 94103-5417

A copy of this manual, including future updates and revisions can be viewed at the following website: <http://www.sfmta.com/bluebook>



## TABLE OF CONTENTS

<b>SECTION 1: PERMITS REQUIRED TO WORK ON CITY STREETS .....</b>	<b>7</b>
<b>1.1 Permits Issued by SFPW .....</b>	<b>7</b>
1.1.1 Excavation Permit.....	7
1.1.2 Temporary Occupancy Permit .....	7
1.1.3 Street Space Permit.....	7
1.1.4 Additional Street Space.....	7
1.1.5 Night Noise Permit.....	7
<b>1.2 Permit Issued by SFMTA (Special Traffic Permit).....</b>	<b>7</b>
1.2.1 Situations Requiring Special Traffic Permits .....	8
1.2.2 Display of Special Traffic Permit .....	8
1.2.3 Special Traffic Permit required for Emergency Work .....	8
1.2.4 Applying for Special Traffic Permits (STP).....	8
1.2.5 Use of SFMTA striping drawings.....	9
1.2.6 Fees for Special Traffic Permits (STP).....	9
1.2.7 Special Traffic Permit (STP) Processing Time .....	9
1.2.8 Length of time an STP is valid .....	9
1.2.9 Maximum area that can be covered in an STP.....	10
1.2.10 Payments for Special Traffic Permits (STP) and Draw-Down Accounts..	10
1.2.11 Special Traffic Permit - Prior Payments Required .....	10
1.2.12 Indemnification .....	10
1.2.13 Revocation of Special Traffic Permit .....	11
<b>1.3 Other Permits .....</b>	<b>11</b>
1.3.1 California Department of Transportation (Caltrans).....	11
1.3.2 Port of San Francisco .....	11
1.3.3 Recreation and Park Department.....	12
1.3.4 SFMTA Rail Clearance Permit .....	12
<b>SECTION 2: WORKING ON STREETS WITH SPECIAL RESTRICTIONS.....</b>	<b>13</b>
<b>2.1 Streets of Major Traffic Importance (Appendix C, Table 1) .....</b>	<b>13</b>
<b>2.2 Restrictions in Certain Areas.....</b>	<b>13</b>
2.2.1 Area of Important Streets – Downtown (Appendix D, Map 1A).....	13
2.2.2 Restrictions for Moscone Convention Center Events (Appendix D, Map 2)..	13
2.2.3 Ball Park Restrictions (Appendix D, Map 3) .....	13
2.2.4 Holiday Moratorium.....	13
2.2.5 Major Muni Routes.....	15
<b>SECTION 3 LANE CLOSURE REQUIREMENTS .....</b>	<b>18</b>
<b>3.1 Closing a Lane.....</b>	<b>18</b>
<b>3.2 Traffic Lane Requirements.....</b>	<b>18</b>
<b>3.3 Temporary Traffic Lanes and Transition Lengths.....</b>	<b>19</b>
<b>3.4 Multi-Lane Shifts .....</b>	<b>19</b>
<b>3.5 Flag Control.....</b>	<b>21</b>
<b>3.6 Coordination with Others .....</b>	<b>21</b>
<b>SECTION 4: PARKING REMOVAL .....</b>	<b>22</b>
<b>4.1 Legal Use of Temporary Tow-Away Zones .....</b>	<b>22</b>
<b>4.2 Registering Tow-Away Signs.....</b>	<b>22</b>

4.2.1	Registering Tow-Away Authorized by Public Works .....	22
4.2.2	Registering Tow-Away Authorized by SFMTA (the Tow-Desk).....	23
<b>4.3</b>	<b>“Tow-Away No Stopping” Sign Requirements.....</b>	<b>23</b>
4.3.1	“Tow-Away No Stopping” Sign Requirements for SFPW Signs .....	23
4.3.2	“Tow-Away No Stopping” Sign Requirements for SFMTA Signs .....	23
<b>4.4</b>	<b>Posting Procedures for SFMTA Signs.....</b>	<b>24</b>
<b>SECTION 5:</b>	<b>SIDEWALK CLOSURES.....</b>	<b>25</b>
5.1	Clear Path of Travel .....	25
5.2	Sidewalk Closure Guidelines .....	25
<b>SECTION 6:</b>	<b>STRIPING AND PAVEMENT MARKINGS .....</b>	<b>26</b>
6.1	Temporary Pavement Markings.....	26
6.2	Temporary Pavement Black-out Markings.....	27
6.3	Laying Out Temporary Striping (Cat Tracking) .....	27
6.4	Permanent Pavement Marking Restoration .....	27
6.5	Muni Markings.....	28
<b>SECTION 7:</b>	<b>TRANSIT OPERATIONS.....</b>	<b>29</b>
7.1	Bus Stops .....	29
7.2	Overhead Wires.....	29
7.3	Passenger Facilities.....	30
7.4	Tracks .....	30
<b>SECTION 8:</b>	<b>SCHOOL ZONES .....</b>	<b>32</b>
<b>SECTION 9:</b>	<b>BICYCLE ROUTES.....</b>	<b>33</b>
9.1	Bike Paths (Class 1).....	33
9.2	Bike Lanes (Class 2).....	33
9.3	Bike Routes (Class 3).....	33
9.4	Closure of Bike Routes.....	33
<b>SECTION 10:</b>	<b>TRAFFIC CONTROL BY SAN FRANCISCO OFFICERS (SFMTA OR SFPD) .....</b>	<b>34</b>
10.1	Duties of Officers .....	34
10.2	Requesting Officers.....	34
10.3	Officer Working Hours.....	34
10.4	Notification and Restrictions .....	34
10.5	Furnishing Permits to Officers .....	35
10.6	Officer Reassignment.....	35
<b>SECTION 11:</b>	<b>DETECTORS IN CITY STREETS.....</b>	<b>36</b>
11.1	Vehicle Detectors in the Work Area .....	36
11.2	Vehicle Sensors in the Work Area .....	36
11.3	Bicycle Counter Detectors in the Work Area.....	37
11.4	Working Around Parking Stall or Roadway Sensors .....	37
11.5	Other Traffic-Related Devices in the Work Area .....	38
<b>SECTION 12:</b>	<b>EMERGENCY PROCEDURE AND CONSTRUCTION ZONE STANDARDS.....</b>	<b>39</b>

<b>12.1</b>	<b>Emergency Procedure</b> .....	<b>39</b>
<b>12.2</b>	<b>Construction Zone Standards</b> .....	<b>39</b>
12.2.1	Tow-Away Lanes .....	39
12.2.2	Metal Plating .....	40
12.2.3	Transitioning (Ramping).....	40
12.2.4	Cyclone Fences .....	40
12.2.5	Placement of Message and Arrow Boards, and Other Devices .....	40
<b>SECTION 13: PENALTIES, CITATIONS AND ADMINISTRATIVE REVIEW</b> .....		<b>42</b>
13.1	Safe Paths of Travel (SPOT) Citations .....	42
13.2	Types of Citations .....	42
13.3	Payments for Citations .....	42
13.4	Hearings and Administrative Review for Citations .....	42
<b>APPENDIX A: SECTION REMOVED</b> .....		<b>44</b>
<b>APPENDIX B: SECTION REMOVED</b> .....		<b>44</b>
<b>APPENDIX C: STREETS OF MAJOR TRAFFIC IMPORTANCE</b> .....		<b>45</b>
<b>APPENDIX D: MAPS</b> .....		<b>60</b>
<b>APPENDIX E: SIGN CHARTS</b> .....		<b>67</b>
<b>APPENDIX F: TYPICAL LANE CLOSURE PLANS</b> .....		<b>79</b>
<b>APPENDIX G: CONTACT INFORMATION</b> .....		<b>100</b>
<b>APPENDIX H: FORMS</b> .....		<b>102</b>

## **Section 1: PERMITS REQUIRED TO WORK ON CITY STREETS**

The following is a list of different types of permits issued by San Francisco Public Works (SFPW), the San Francisco Municipal Transportation Agency (SFMTA), and other agencies.

Permits must be kept on the job site at all times and be shown to City employees and police officers upon request. Citations may be issued under the Transportation Code for failure to produce a valid permit.

### **1.1 Permits Issued by SFPW**

#### **1.1.1 Excavation Permit**

An excavation permit is required for any excavation work within the public right-of-way.

#### **1.1.2 Temporary Occupancy Permit**

A temporary occupancy permit is required for work that involves the use of the sidewalk or a portion of the street pavement, up to one full day, to perform building maintenance work (e.g., using a crane occupying a parking space or pruning trees).

#### **1.1.3 Street Space Permit**

A street space permit is required for work that involves the use of the sidewalk or a portion of the street pavement outside of the building property line or project limits, for building and project construction, respectively. A Special Traffic Permit is required for work outside of the limits defined in a Street Space Permit (see Section 1.2).

#### **1.1.4 Additional Street Space**

Additional Street Space (ADS) for buildings allows the contractor to extend the boundaries of a Street Space Agreement. ADS is used for long term occupancies. Occupancies over 3 months that occur more than two (2) times per week will be referred for Additional Street Space.

#### **1.1.5 Night Noise Permit**

Any work done between the hours of 8 p.m. and 7 a.m. in the roadway or sidewalk area requires a night noise permit as specified in Section 2908 of the Police Code.

### **1.2 Permit Issued by SFMTA (Special Traffic Permit)**

A Special Traffic Permit (STP) is required for any work that does not comply with the regulations in this manual or the Traffic Routing Specifications in a City Contract. A Contractor must apply for an STP a minimum of two business days before undertaking said work. The SFMTA is authorized to review permit requests and issue permits at its

discretion. SFMTA may refuse to issue, extend or may revoke an STP depending on the traffic conditions. This section lists the most commonly asked questions regarding STPs.

### 1.2.1 Situations Requiring Special Traffic Permits

Whenever the Contractor cannot follow all of the requirements and regulations in this manual, an STP is required. The most common examples are:

**Table 1:** Situations Requiring Special Traffic Permits

Situation	Applicable Sections
1. Closing a street or an alley	3.2 and 4
2. Closing a sidewalk (no path of travel)	5
3. Inability to provide the required number of lanes	3.2
4. Shifting or closing lanes on streets in Table 1, (Appendix C)	2
5. Work through Holiday Moratorium	2.2.4
6. Exceeding Contract Specifications	–
7. Exceeding Street Space Agreement	1.1.3
8. Working within one block of an existing construction area	3.5
9. Moving a bus zone outside the limits of the project.	6.2.3 and 7
10. Closing or detouring bike routes (including paths, marked lanes, and signed routes).	9

### 1.2.2 Display of Special Traffic Permit

Permittees must maintain the permit at the site and must make all permits available for inspection upon request by an employee of the Police Department or SFMTA, or a resident engineer or inspector.

### 1.2.3 Special Traffic Permit required for Emergency Work

If work extends into the next business day and is non-compliant with regulations set forth in this manual, the Contractor has four (4) hours to apply for an STP to continue work (see Emergency Procedure, Section 12).

### 1.2.4 Applying for Special Traffic Permits (STP)

Use the Special Traffic Permit application form found in Appendix H; or download the application from [www.sfmta.com/bluebook](http://www.sfmta.com/bluebook). Send the completed application and drawings via e-mail to the traffic permits inbox at [trafficpermits@sfmta.com](mailto:trafficpermits@sfmta.com). Note that if your project is a city capital project (for example an SFPW paving or SFPUC water or sewer contract), completed applications and drawings must be sent to your assigned traffic engineer and copied to the resident engineer or inspector (do not use the traffic permits inbox). Use SFMTA striping drawings to clearly show the planned work. The Contractor will be notified by email if the permit request is approved or denied. If approved, the Contractor will be emailed a copy of the permit and the fee amount will be debited in an electronic account maintained by SFMTA. (See Section 1.2.10).



### 1.2.5 Use of SFMTA striping drawings

The use of striping drawings (showing details and dimensions of lane line markings in the streets) is strongly recommended for processing permits and for planning work. For sites in blocks with complicated geometry (such as turn lanes, islands, bulb-outs, lane transitions, etc.) striping drawings are necessary to prepare a clear and concise application. Striping drawings are generally available from the following link: [www.sfmta.com/striping](http://www.sfmta.com/striping)

### 1.2.6 Fees for Special Traffic Permits (STP)

- NEW PERMITS: \$388 processing fee + \$78 / day
- RENEWALS: \$194 processing fee + \$78 / day  
(for identical permits less than 90 days old)

**NOTE:** The renewal processing fee discount applies only if the renewal request is done correctly, on time, and with the same hours, location, and lane requirements.

All fees are subject to change. Please check the link below for current fees:  
[sfmta.com/permits/special-traffic-permits-stp](http://sfmta.com/permits/special-traffic-permits-stp)

### 1.2.7 Special Traffic Permit (STP) Processing Time

Special traffic permits are prepared and reviewed by SFMTA Traffic Engineering staff. Permits provide details specific to each site and activity, and typically list traffic plan details, signage, traffic control devices and special conditions, while maintaining compliance with local, state and federal standards, such as the Manual on Uniform Traffic Control Devices (MUTCD). These permits require adequate time to prepare, review and to ensure there are no conflicts between the work and Muni, events and other work in the vicinity. The following minimum application deadlines are required to design and create each permit.

Renewal permits require a minimum of two (2) working days. New permits may require five (5) working days. More complicated requests may take longer. Very complex permit applications, such as Tower Crane Erections, Concrete Mat Pours and Complex road closures require a minimum of 8 weeks processing time. SFMTA reserves the right to request additional processing time as needed. Note that in order to meet these processing times, applications must be complete and contain all necessary drawings and dimensions.

A “Working day” is defined as a full day between 8 a.m. and 5 p.m. during which the SFMTA is open for business (generally Monday through Friday, not including city holidays). For the purpose of counting any particular day as a “full working day” a permit application or renewal must be in the traffic permits email inbox by 10am.

### 1.2.8 Length of time an STP is valid

STPs are issued for no more than 31 calendar days (or one month), after which

contractors are required to renew. To renew an STP, e-mail the most recent permit to SFMTA ([trafficpermits@sfmta.com](mailto:trafficpermits@sfmta.com)) with the new date(s) and new time(s) requested. For faster processing, please do not obscure the old dates, times or permit numbers.

#### 1.2.9 Maximum area that can be covered in an STP

No permit will be issued for any area greater than two (2) adjacent city blocks. Larger areas will require two (2) or more permits.

#### 1.2.10 Payments for Special Traffic Permits (STP) and Draw-Down Accounts

All contractors who are issued STPs will be provided an STP account that tracks their STP fees and fee payments. Each company may have only one account. Multiple sites under the same company must use a single account. Contractors should provide SFMTA with the name, email address, and phone number of the contractor's employee, who will oversee the account and ensure STP fees are paid, usually the finance officer or accountant. Contractors with an account debit or with STP activity in the past month will receive an email after the end of the month containing detailed STP fee and payment information, along with copies of any STPs issued that month.

Contractors who apply for permits are required to maintain a positive balance in their STP account. SFMTA will use these funds to pay for permits issued. SFMTA may, at their discretion, stop issuing STPs to all construction sites under the same contractor with unpaid STP fees. All permits have a cost listed on the bottom, so each permit serves as a receipt.

To pay for STPs or to pre-fund an STP account, deposit a check, made out to "SFMTA", with "Special Traffic Permit Draw- Down" printed on it and mail to:

SFMTA  
1 South Van Ness, 7<sup>th</sup> Floor,  
San Francisco, CA, 94103  
Attn: STP Account

#### 1.2.11 Special Traffic Permit - Prior Payments Required

- a. No permit shall be issued or renewed until the applicant has paid all permit fees that are due to the SFMTA.
- b. No permit shall be issued to any applicant who is responsible for payment of one or more delinquent citations issued for violation of any provision of this manual, until all fines and fees associated with citations are paid in full, or the violation is dismissed and/or adjudicated.

#### 1.2.12 Indemnification

Permit applications for Special Traffic Permits, and permits for the Temporary and

Exclusive Use of Parking Meters, shall require the applicant to acknowledge that the Permittee, by acceptance of the permit, agrees to indemnify and hold the City and County of San Francisco, its departments, commissions, boards, officers, employees and agents ("Indemnitees") harmless from and against any and all claims, demands, actions or causes of action which may be made against the Indemnitees for the recovery of damages for the injury to or death of any person or persons or for the damage to any property resulting directly or indirectly from the activity authorized by the permit regardless of the negligence of the Indemnitees.

### 1.2.13 Revocation of Special Traffic Permit

The SFMTA may revoke the permit of any Permittee found to be in violation of an STP or this manual, present a public safety issue or for other reasons deemed necessary by the SFMTA. Upon notice of revocation, the Permittee must return the site to conditions that meet the standards of all sections in this manual and / or conditions authorized by any other valid permit.

## 1.3 Other Permits

In addition to the above permits, the Contractor is required to contact the following agencies for work on certain City Streets. Contact information can be found in Appendix G.

### 1.3.1 California Department of Transportation (Caltrans)

Caltrans has jurisdiction over the state route system in San Francisco, including:

State Route	Local Designation, Limits
U.S. 101	Richardson Avenue, Lombard Street, Van Ness Avenue, So. Van Ness Avenue, Mission Street
S.R. 1	19 <sup>th</sup> Avenue, Crossover Drive, Park Presidio Blvd, Junipero Serra
S.R. 35	Skyline Boulevard, Sloat Boulevard
S.R. 82	San Jose Avenue
Freeways	All intersections involving freeway off-ramps and on-ramps

### 1.3.2 Port of San Francisco

The Port of San Francisco (<https://sfport.com/>) has jurisdiction over the following streets:

- The Embarcadero
- Jefferson Street
- Illinois Street
- Other City streets, typically one block away from the north and east waterfront

### 1.3.3 Recreation and Park Department

The Recreation and Park Department (<https://sfrecpark.org/>) has jurisdiction over the following streets:

- All Streets inside Golden Gate Park and McLaren Park
- Great Highway
- Other Streets

### 1.3.4 SFMTA Rail Clearance Permit

If Contractor is working within 72 inches of the outside edge of SFMTA track, including cable car and light rail tracks (the “Safety Envelope”), Contractor must obtain a clearance permit from SFMTA Transit Management Center before performing any work. If workers will be within the Safety Envelope, the Contractor must comply with and train its workers per the SFMTA Roadway Worker Protection program in addition to obtaining a clearance permit. Contact the SFMTA System Safety at [roadwayworkerprotection@sfmta.com](mailto:roadwayworkerprotection@sfmta.com). Please use the link below to start the application process:

<http://www.sfmta.com/permits/muni-construction-support-and-clearance-permit>

## **Section 2: WORKING ON STREETS WITH SPECIAL RESTRICTIONS**

Depending on the work site, there are certain restrictions that will apply. This section identifies streets where work is limited by time of day or day of the week. In some instances contractors may be restricted to working during evenings and weekends.

### **2.1 Streets of Major Traffic Importance (Appendix C, Table 1)**

Table 1 in Appendix C lists the City streets by direction of travel, on which traffic lanes must be kept clear during certain times of the day, and the restricted hours for each block. No work resulting in shifting or closing traffic lanes is allowed on listed streets during the specified hours. This includes any hole, debris, or material or equipment in the traffic lanes, including tow-away lanes, during these hours. Streets marked “Caltrans Jurisdiction” are within Caltrans’ Jurisdiction and require an encroachment permit from the State, in addition to any city permits. Caltrans may determine working hours or defer to the City of San Francisco for working hours determined by SFMTA.

### **2.2 Restrictions in Certain Areas**

Streets with heavy traffic in the downtown area, streets with transit lines, streets that lead to Oracle Park, and streets containing bicycle routes all have special restrictions. Contractor is responsible for complying with these restrictions.

#### **2.2.1 Area of Important Streets – Downtown (Appendix D, Map 1A)**

Map 1A outlines the downtown area. Within the bounded area construction activity is limited on certain street segments from 7 a.m. to 9 a.m., and 3 p.m. to 7 p.m., Monday to Friday and other segments are further restricted. Refer to Appendix C, Table 1 for specific street segments with these hours restrictions.

#### **2.2.2 Restrictions for Moscone Convention Center Events (Appendix D, Map 2)**

The streets around Moscone Convention Center are subject to restricted construction hours during major events at the Center. No construction activity is allowed one hour before to one hour after these events.

#### **2.2.3 Ball Park Restrictions (Appendix D, Map 3)**

The streets around Oracle Park and Chase Center are subject to restricted construction hours during major events at the ball parks. No construction activity is allowed from two (2) hours before to two (2) hours after these events.

#### **2.2.4 Holiday Moratorium**

No construction work is allowed in the public right of way from the day after Thanksgiving to January 1, inclusive, during the hours of 7 a.m. to 10 p.m. on Holiday Moratorium protected streets. On protected streets all openings in the street and in the sidewalk must be closed by backfilling and paving or by plating over, providing safe and adequate passage for bicycles, vehicles and pedestrians.

Work may be allowed between the hours of 10 p.m. and 7 a.m. as long as the proper night noise permit is obtained.

**A. Protected Streets** - The following streets are considered Holiday Moratorium protected:

- i. **Any Street Within the Area Shown in Figure 1:** This area is bounded by Pine Street, Taylor Street, Market Street, 8<sup>th</sup> Street, Folsom Street, Fremont Street, and Front Street, inclusive, and includes all streets. Alleys are not included in the Holiday Moratorium restriction unless they meet the criteria of a Business Block in the City (see paragraph ii below). Alleys are defined as streets under 25' wide from curb to curb.

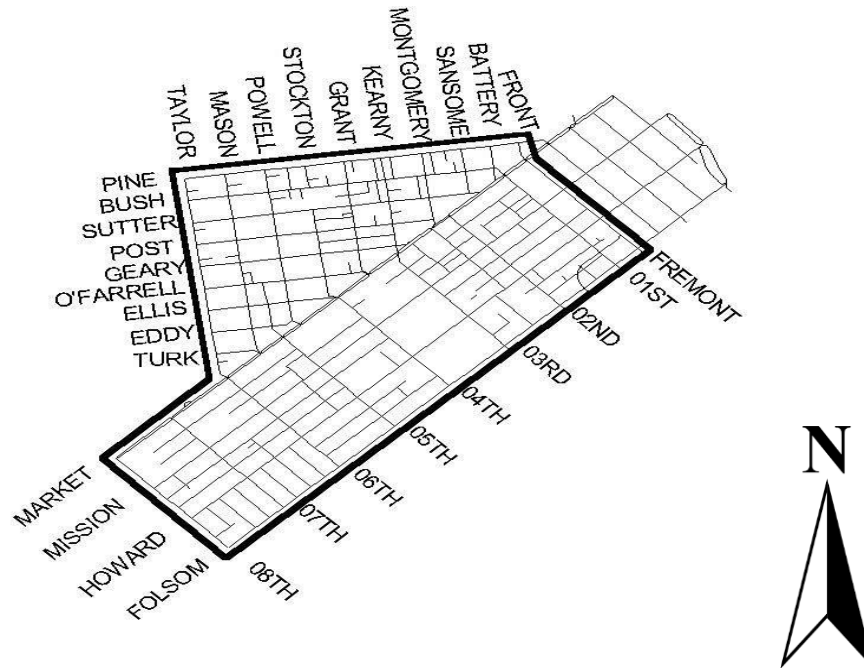

**Figure 1: Holiday Restrictions Boundary**

- ii. **Any Business Block in the City:** A Business Block is any City block (including alleys) where at least 50 percent of the frontage is devoted to business. Frontage is defined as the measurement of the length of a building facing the subject street and only includes buildings with entry on the subject street. Establishments in this category are retail stores, grocery stores, bars, restaurants, non-residence type hotels and other retail businesses as determined by the SFMTA. Gas stations, parking lots and garages, government and private offices, repair shops, wholesale businesses that are not open to the public and businesses which are exclusively manufacturing, construction, professional or financial services, while all important, are not considered holiday retail businesses for the purposes of the Holiday Moratorium.

**Business Block Evaluation:** If work is planned during the Holiday Moratorium on a block that appears to be 50 percent or more protected commercial frontage, contractors should complete the Holiday Moratorium form available at the following link:

<https://www.sfmta.com/media/33044/download?inline>

and email a copy to SFMTA permit staff at [TrafficPermits@sfmta.com](mailto:TrafficPermits@sfmta.com)

## B. Conditional Approval and Waivers

- i. **Conditional Holiday Moratorium Approval.** Applicants may apply for “Conditional Approval” to work on any street that has up to 75% business and is outside the map area in Figure 1 above (or on alleys within the map area). When applying for “Conditional Approval”, the applicant does not have to complete a full “Holiday Moratorium Business Block Survey.” If granted, the applicant may work as long as no valid objection is received at SFMTA. Following any valid objection, Conditional Approval may be revoked and work ceased until the applicant receives a standard Holiday Moratorium waiver.
- ii. **Standard Holiday Moratorium Waiver.** Applicants may request a standard Holiday Moratorium waiver from affected businesses if the block is protected. Applicants who request a waiver must be prepared to detail the hours of operation of businesses and obtain written approval from property and business owners. Please contact the SFMTA prior to contacting the public about a Holiday Moratorium waiver.

To request a standard Holiday Moratorium waiver, the contractor shall prepare a map of each block and a table listing businesses and their approvals and submit them along with copies of written approvals from the businesses and completed “Holiday Moratorium Business Block Survey” form for SFMTA to review. The contractor should use the City assessor map and the Holiday Moratorium worksheet for this documentation available at the following links:

Assessor Map:

<https://sfplanninggis.org/pim/?pub=true>

Holiday Moratorium worksheet:

[https://www.sfmta.com/sites/default/files/reports-and-documents/2020/09/2020\\_holiday\\_moratorium\\_worksheet-sipv2.xlsx](https://www.sfmta.com/sites/default/files/reports-and-documents/2020/09/2020_holiday_moratorium_worksheet-sipv2.xlsx)

SFTMA staff will review the Holiday Moratorium documents, make a decision and return a completed copy of the form to the contractor. If the block(s) are not Holiday Moratorium protected **or** SFMTA has received all written approvals, then SFMTA will approve the waiver on the form and work may continue. The contractor shall keep a copy of the form on site to show City staff (inspectors, engineers or enforcement personnel). The contractor must include approved Holiday Moratorium forms along with any traffic permits applied for during the Holiday Moratorium period. Holiday Moratorium documents are valid for the year in which they are submitted.

### 2.2.5 Major Muni Routes

Some routes in the Muni system are designated “Major Muni Routes”. In order to facilitate traffic flow for Muni vehicles and for the general public, construction activity is limited on certain street segments citywide from 4 p.m. to 7 p.m., Monday through Friday. In addition, construction activity is further limited on certain street segments along Major Muni Routes that are in the Area of Important Streets (see Appendix D, Map 1A), between the hours of 7 a.m. to 9 a.m. and 3 p.m. to 7 p.m., Monday through Friday. Refer to Appendix C, Table 1 for specific street segments with these hours restrictions and other segments that are further restricted.

Table 2 in this section lists routes that are considered “Major Muni Routes”. The Contractor should become familiar with the routes of the coach lines operating within the work area. For further information on Muni routes or schedules, visit the SFMTA’s website at [www.sfmta.com](http://www.sfmta.com) or call SFMTA at 311.



**Table 2: Major Muni Routes**

Muni Line		Name	Muni Line		Name
<b>BUS &amp; TROLLEY LINES</b>			<b>CABLE CARS (CC)</b>		
1	✓	California	C	✓	California
2	✓	Clement	PH	✓	Powell-Hyde
5	✓	Fulton	PM	✓	Powell-Mason
7	✓	Haight-Noriega			
8X	✓	Bayshore Express	<b>RAIL LINES</b>		
9	✓	San Bruno	F	✓	Market
10	✓	Townsend	J		Church
12	✓	Folsom/Pacific	K		Ingleside
14	✓	Mission	L		Taraval
19	✓	Polk	M		Ocean View
21	✓	Hayes	N	✓	Judah
22		Fillmore	T	✓	Third
24		Divisadero			
28		19 <sup>th</sup> Avenue			
29		Sunset			
30	✓	Stockton			
31	✓	Balboa			
38	✓	Geary			
41	✓	Union			
43		Masonic			
44		O'Shaughnessy			
45	✓	Union-Stockton			
47	✓	Van Ness			
48		Quintara			
49	✓	Van Ness-Mission			

✓ = Route services downtown (Map 1A)

## SECTION 3 LANE CLOSURE REQUIREMENTS

### 3.1 Closing a Lane

The Contractor must properly plan, use, place and maintain traffic control devices while in use at the construction site. In general, closing a traffic lane requires the use of a flashing arrow board. Solar or battery powered flashing arrow boards are required in residential areas, especially at night, to minimize noise problems. For certain lane closures, the use of high-level warning flags along with other devices in place of flashing arrow board is acceptable. Flashing arrow boards and high level warning flags must be installed in accordance with the California MUTCD. Typical lane closure plans are presented in Appendix F.

### 3.2 Traffic Lane Requirements

The Contractor shall provide the required number of through traffic lanes according to the table and notes below.

**Table 3:** Traffic Lane Requirements Per Direction

Existing Number of Through Traffic Lanes	Minimum Number of Through Traffic Lanes to Remain Open
1	1
2	1
3	2
4	2
5	3
6	4

Notes:

- A. For two-way streets, Contractor shall consider each direction separately. For example, a four-lane road with two lanes in each direction shall provide a minimum of one lane in each direction.
- B. **Lane Widths:** The minimum width required for a single traffic lane is 12 feet. The minimum width required for a vehicular traffic lane contiguous to one or more vehicular traffic lanes in the same direction is 10 feet. Lane widths must be clear of any obstructions, including traffic cones and delineators.
- C. **Existing Turn Lanes:** When streets have existing left and/or right turn lanes, Contractor must provide a separate 10' wide left and/or right turn lane of equal length to the existing turn lane. Turn lanes must be provided in addition to maintaining the required number of through lanes in Table 3.
- D. **Within 100 Feet of an Intersection - Streets with Two Lanes in the Same Direction – Without Existing Turn Lanes:** This applies where two lanes in

a single direction are reduced to one lane and because of a traffic lane closure, through vehicles cannot physically pass a left or right turning vehicle. Contractor shall provide a left and/or right turn lane (each lane minimum 10' wide, 50' long), **or** shall request a Special Traffic Permit to prohibit left and/or right turns at the intersection and post a signed detour for each prohibited turn.

- E. **Two-Way “Reversible Lane” Flag Control:** Completely closing any direction of traffic is not allowed without a valid Special Traffic Permit or a SFMTA approved traffic routing plan. This includes any plan which allows one lane to be used for two directions of traffic (“Two-Way Flag Control”).
- F. **Roadway Closures:** The complete closure of a roadway is not permitted without a valid Special Traffic Permit or a SFMTA approved traffic routing plan.
- G. **Muni Trolley Coaches:** Contractor is responsible for ensuring that the lanes provided allow Muni trolley coaches to reach the overhead wires at all times (see Section 7.2 for details).
- H. **Traffic Signal Visibility:** When lanes are shifted the Contractor must ensure that at least two traffic signal heads are visible from the shifted lanes. Requirements for visibility may be seen in the MUTCD. Temporary traffic signal heads may be provided as needed or personnel posted to mitigate the loss of visibility.
- I. **Complex Traffic Signal Phasing:** Some intersections have traffic signals with Bicycle, Vehicular Turn Phases and Turn Restriction Blank-Out indications. At intersections where these indications appear, separate dedicated traffic lanes must be provided to accommodate traffic or bicycles that will be required to use the signals to move through the intersection. In these cases, these special lanes cannot be closed without first mitigating the conflicts caused by the special traffic signal phases.

### 3.3 Temporary Traffic Lanes and Transition Lengths

Space for a traffic lane(s) can be made available by temporarily prohibiting parking. Full transition length must be provided when shifting or ending a traffic lane. Transition lengths calculated using the California MUTCD formula  $L = ws^2/60$ , where “L” is the transition length, “w” is width across which the lane is being laterally shifted, and “s” is the speed. (Units for the formula in feet and miles/hour).

### 3.4 Multi-Lane Shifts

When shifting multiple lanes (2 or more), the Contractor must provide transition delineation for each lane shifted. If the parking strip is used to route vehicular lanes, the contractor must shift each lane with physical traffic control devices or traffic lane tape. The contractor must channelize each lane into and out of the curb space provided for the temporary lanes. See Figures 3.4a, b and c.

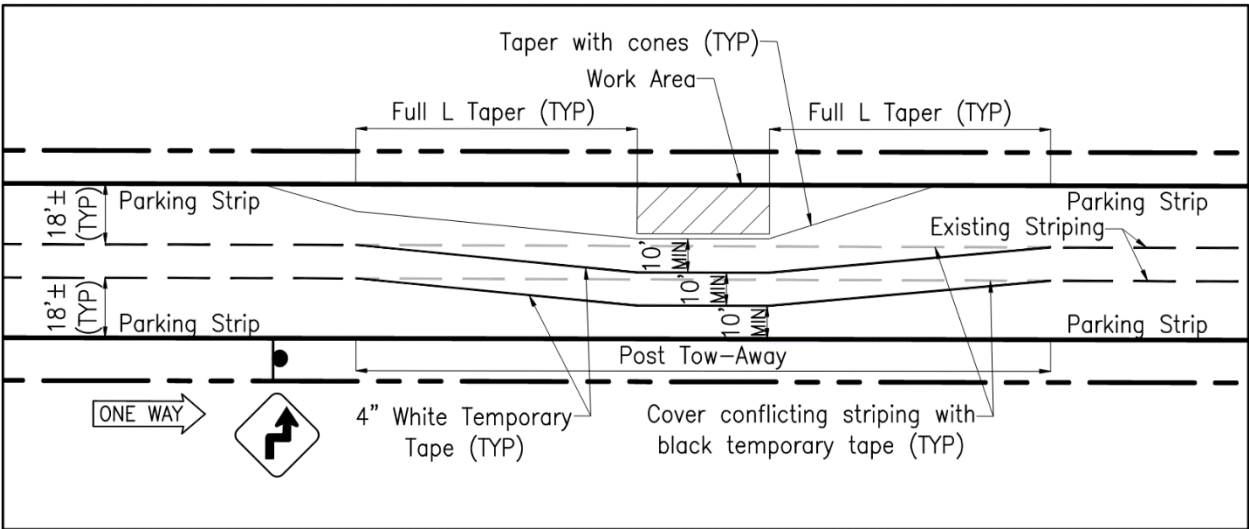

Figure 3.4a: One-Way Multi-lane Shift with Curbside Worksite

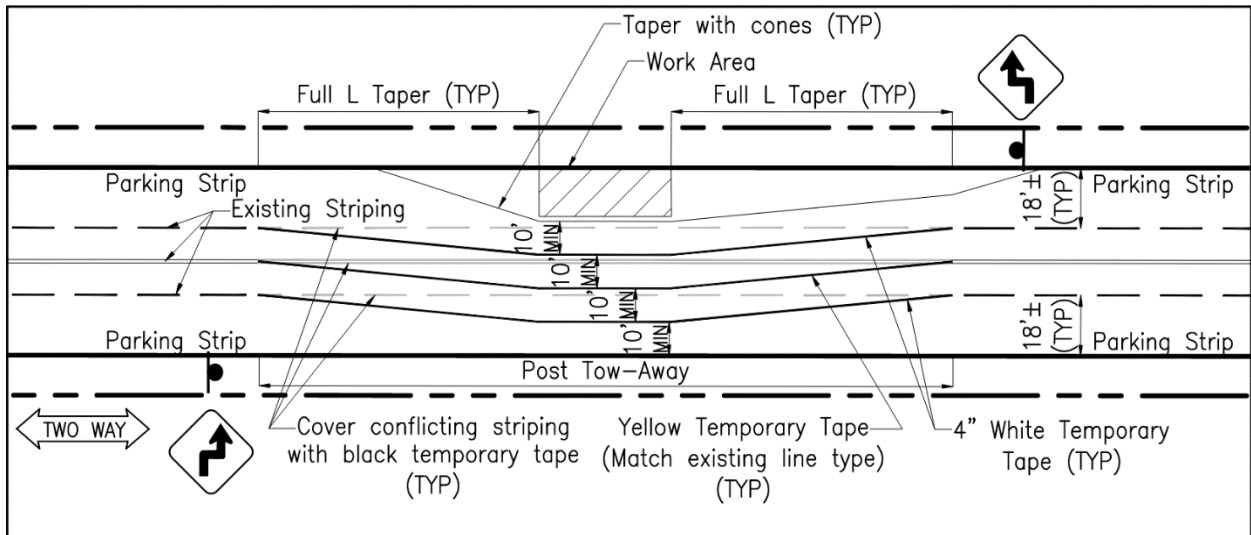

Figure 3.4b: Two-Way Multi-lane Shift with Curbside Worksite

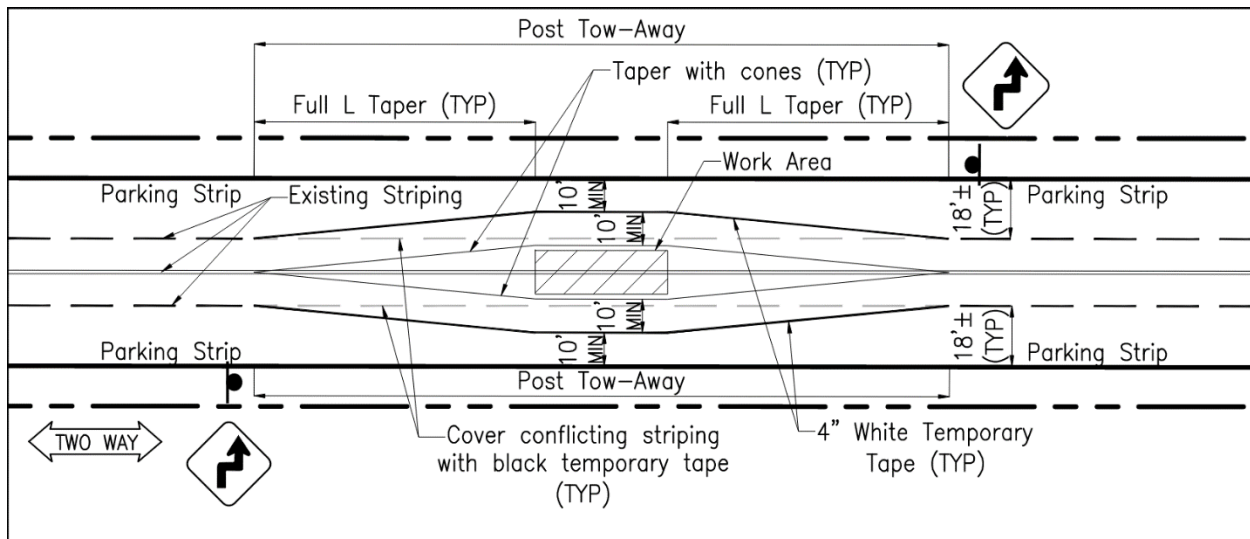

Figure 3.4c: Two-Way Multi-lane Shift with Center Worksite

### 3.5 Flag Control

Flaggers may be required by Contract Specifications or an STP.

The following rules apply to flaggers:

- Flaggers must be properly equipped with a Type II vest (daytime) or Type III (nighttime) and a sign paddle.
- Flaggers must be certified and must have their certification card at all times.
- When an STP or Contract Specification allows the use of one lane for two directions of traffic (i.e., Two-Way Flag Control), a minimum of two (2) flaggers are required.
- SFMTA or SFPD Officers may be hired to provide flag control (see Section 10 for details).

### 3.6 Coordination with Others

In order to ensure that the traffic lanes provided are adequate and continuous, only one contractor at a time is allowed to work on any one block. If a second contractor is planning to work on that block or on an adjacent block, then the second contractor shall obtain an STP before starting any work. Moreover, a contractor is not allowed to work within a block of a project under City Contract without the approval of the Resident Engineer of the subject contract, and an STP may be required.

## Section 4: PARKING REMOVAL

### 4.1 Legal Use of Temporary Tow-Away Zones

Parking must not be prohibited where there is no construction activity. Construction tow-away zones must be used for construction activities only, such as loading, unloading, storage of materials, special equipment occupancy, etc. These zones do **NOT** allow for parking of vehicles not actively involved in construction, including private vehicles and any company vehicles not engaged in the work. Such vehicles are subject to citation.

Workers' parking is not allowed within a construction tow-away zone during the effective hours of the tow zone. Infractions related to the regulations listed in this section are grounds for revocation of tow-away zones.

Tow-Away signs must be posted and registered with the SFMTA Tow-Desk or SF Public Works online at least 72 hours prior to the enforcement date. Signs marking temporary tow-away zones that are not registered at least 72 hours in advance are considered inactive and the marked tow-away zone will not be enforced or towed.

Construction tow-away zones can be registered for the duration of the permit associated with them. If additional time is needed to complete construction, the Contractor may request a time extension from the agency that issued the permit and follow the tow zone registration procedure shown in section 4.2 below. Approval of a time extension must be obtained and new signs must be posted and registered at least 72 hours prior to the expiration of the previous registered valid period of the tow zone for the tow zone to be continuously enforceable.

### 4.2 Registering Tow-Away Signs

The Contractor must post and register “Tow-Away No Stopping” signs to have authority to clear the parking lane for construction work. Registration via specific city departments varies according to the work performed and type of base permits issued.

The following table provides a summary of the most common permits requiring Tow-Away registration:

<b>Type of Permit / Activity</b>	<b>Registration Via</b>	<b>Sections</b>
Additional Street Space (SFPW)	SF Public Works	4.2.1
Excavation Permits (SFPW)	SFMTA	4.2.2
Mobile Storage Containers	SF Public Works	4.2.1
Moving Van Parking	SFMTA Temp Sign Shop - Call 311	-
Special Traffic Permits (SFMTA)	SFMTA	4.2.2
Street Space (Building Permits) SFPW	SF Public Works	4.2.1
Temporary Occupancy (SFPW)	SF Public Works	4.2.1

#### 4.2.1 Registering Tow-Away Authorized by Public Works

Activating Tow-Away signs via the SF Public Works (SFPW) process requires posting signs and providing photographic proof that the signs were posted in the field at least 72 hours in advance. SFPW provides a link to download fully designed signs with the pertinent data filled in for you. A description of the SFPW process is posted here:

[Tow-Away Sign Activation and Photo Upload.pdf \(sfpublicworks.org\)](https://sfpublicworks.org/sites/default/files/Tow-Away%20Sign%20Activation%20and%20Photo%20Upload.pdf)  
<https://sfpublicworks.org/sites/default/files/Tow-Away%20Sign%20Activation%20and%20Photo%20Upload.pdf>

#### 4.2.2 Registering Tow-Away Authorized by SFMTA (the Tow-Desk)

Activating Tow-Away signs via the SFMTA process requires creating an account through which you register your tow zone. Signs are created by using a standard template and filling in the data yourself. Signs must be posted in the field at least 72 hours in advance. The Contractor must follow the procedure found here: <https://www.sfmta.com/permits/construction-tow-away-zones>

### 4.3 “Tow-Away No Stopping” Sign Requirements

Tow-Away signs must be printed 11"x17" size, in color (red, black and white), and properly displayed and maintained. Tow-Away signs must be printed, not hand-written.

#### 4.3.1 “Tow-Away No Stopping” Sign Requirements for SFPW Signs

Tow-away signs issued by SFPW for construction zones must meet the requirements described in SFPW Order No. 183160. For tow-away signs authorized by SFPW, the Contractor can download a pdf file of the tow-away signs for posting.

SFPW Order No. 183160 can be found here:  
<https://sfpublicworks.org/sites/default/files/4505-K2%20DPW%20Order%28183160%29.pdf>

Information on SFPW Tow-Away signage can be found here:  
<https://sfgov.org/mod/sites/default/files/FileCenter/Documents/2174-ShowDocument.pdf>

#### 4.3.2 “Tow-Away No Stopping” Sign Requirements for SFMTA Signs

The Contractor is responsible for creating their own tow-away signs when tow-away signs are authorized by SFMTA. Tow-away signs authorized by SFMTA for traffic control purposes must comply with the following:

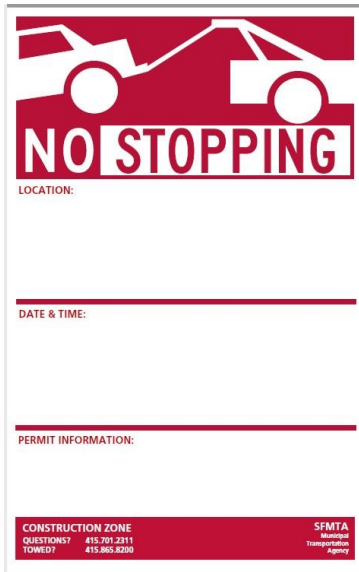

- A. Size: 11"x17"
- B. Colors: Red and White for the base design, and black print for site specific data
- C. Signs must be printed, not hand-written
- D. All Tow-Away signs must have the following information:

1. Times and Dates of active Tow-Away Zone
2. Street, Cross Street & Side of Street (Addresses if available)
3. Traffic Permit (STP) or SFPW Excavation Permit Number
4. Name of Contractor
5. Contact Phone Number

#### 4.4 Posting Procedures for SFMTA Signs

Tow-away signs for construction zones must be posted in accordance with the following criteria:

- A. Signs must be posted only within the limits of construction.
- B. Signs must be posted every 20 linear feet of occupied space with at least **one sign at each end** of the occupied space.
- C. Place signs on wood or aluminum backing or approved equal.
- D. Mount the signs securely to existing poles, posts, on Type I, II or III barricades per Caltrans specifications, or on construction fences.
- E. The Contractor must maintain the signs on a continuous basis and shall replace damaged or missing signs daily.
- F. The Contractor must remove the signs and mounting materials immediately after construction has been completed.
- G. Signs must be posted at least 72 hours prior to the enforcement date in order to give the public sufficient notice.

See SFPW guidance for posting of SFPW approved tow signs.



## Section 5: SIDEWALK CLOSURES

### 5.1 Clear Path of Travel

- A 6-foot wide clear path of travel is desirable. At a minimum, Contractor **shall** provide a **4-foot wide** clear path of travel on any sidewalk at all times. More width may be required by SFPW or the SFMTA in areas where heavier pedestrian volumes are expected.
- Any sidewalk closure, walkway closure or any other work that does not provide a continuous 4-foot wide clear path of travel on the same side of the street shall require a Special Traffic Permit (STP).
- Any crosswalk closure shall require an STP. Requests for an STP to close a crosswalk **may** be granted, and generally, only one crosswalk at an intersection is allowed to be closed at a time.
- The STP will require that the Contractor post and maintain the appropriate pedestrian signs, including but not limited to “SIDEWALK CLOSED AHEAD/USE OTHER SIDE”, “SIDEWALK CLOSED”, “NO PEDESTRIAN CROSSING” and “USE ← or → CROSSWALK” (see Signs in Appendix E).

### 5.2 Sidewalk Closure Guidelines

- Requests for an STP to close a sidewalk in the middle of the block are generally not accepted because this results in pedestrians having to walk around the work site, usually out into the street, to continue down the sidewalk.
- Requests for an STP to close the whole block **may** be accepted, but only if the Contractor’s frontage occupies the entire block.
- Requests for an STP to close the sidewalk on a minor alley **may** be granted.
- Requests for an STP to close a typical sidewalk **may** be considered by the SFMTA if off-duty SFPD officers are provided to direct pedestrians back to the last safe crossing, and proper signage is installed.
- Contractors may also route pedestrians into the parking strip provided that a temporary walkway is set up per SFPW’s Barricade Standards. The parking strip cannot be used as a pedestrian walkway during the hours that tow-away is in effect (see Appendix F for Typical Applications).

## Section 6: STRIPING and PAVEMENT MARKINGS

### 6.1 Temporary Pavement Markings

Temporary markers and/or markings must be installed by the Contractor for any existing crosswalk line, limit line, arrow, and other legend or traffic lane line removed or damaged by the work activity prior to the end of the work shift and before opening the lanes for traffic.

The following temporary retroreflective pavement striping and marking products are acceptable for use as defined in Table 4 below.

#### A. Temporary Removable Pavement Tape

The Contractor must use any one of the following removable foil-backed tapes or approved equal:

SUPPLIER	MODEL
Swarco	Visa-Line
Brite-Line	Series 100
ATM	Series 200

#### B. Temporary Reflective Overlay Pavement Markers

The Contractor must use any one of the following or approved equal:

SUPPLIER	SUPPLIER
PEXCO, Davidson Traffic Control Products	Model TOM Temporary Overlay Marker with retroreflective sheeting; Model TRPM Chip Seal Markers
Apex	Model 932 Chip Seal/Overlay Markers
Hi-Way Safety Inc.	Model Chip Seal Markers with retroreflective sheeting

**Table 6.1:** Requirements for Placing Temporary Pavement Markings

Existing Striping	Temporary Striping
12 or 24-inch limit lines and Stop Bars ***	1 – 12 inch white solid stripe **
Transverse Crosswalks (crosswalks formed by two parallel lines) ***	2 - 12 inch lines**
Continental Crosswalks (crosswalks resembling piano keys) ***	Use 12 inch lines as follows**: a. If <u>less than half</u> of the crosswalk is removed, crosswalk must be filled in by replacing the continental bars (piano keys). Contractor may extend missing portions of remaining bars or install bars at 5 foot centers. b. If <u>half or more</u> is removed a temporary transverse

	crosswalk may be installed.
8-inch solid white line	1 – 8 inch white solid stripe **
8-inch broken white	1 – 4 inch white stripe (typically 7' long, 17' gaps*)
4-inch broken white	1 – 4 inch white stripe (typically 7' long, 17' gaps*)
4-inch broken yellow	1 – 4 inch yellow stripe (typically 7' long, 17' gaps*)
Double yellow	2 – 4 inch yellow solid stripes 3 inches apart

\* Dimensions for broken lines on streets with posted speed limits of 35 MPH or less. For streets with posted speed limits of 40 MPH or more, use 12' long stripes with 36' gaps. (See Chapter 3 of the California MUTCD).

\*\* 8 and 12 inch wide lines must be made by putting together either 2 or 3 strips of 4 inch tape to make the appropriate widths.

\*\*\* Pavement markers or chip seals may not be used for these lines. Stop bars and crosswalk lines must be aligned with projections of the property line and the face of curb (unless otherwise indicated on SFMTA striping drawings or directed by the traffic engineer). Crosswalks must span the full width of the roadway and stop bars must span from the curb to the centerline (or yellow stripe).

## 6.2 Temporary Pavement Black-out Markings

The Contractor must use black-out tape to obscure pavement markings, messages and stripes that are in conflict with temporary traffic or bicycle lane channelization (when lanes are relocated). Black-out tape must be black in color, non-reflective and matte finish. Black-out tape used to obscure messages and arrows must cover the original markings using rectangular pieces so that the original arrows and messages are not shown to the driver in black. Black-out lines and markings must not reflect light back to the driver via vehicle headlights from road users or reflect glare from distant light sources. Depending upon the condition of the original striping underneath, the contractor may be required to replace the original lines following construction.

## 6.3 Laying Out Temporary Striping (Cat Tracking)

Prior to installing traffic tape for lane lines (typically when lanes are shifted), the Contractor must lay out the temporary traffic pattern using rope and spray paint to mark the proposed layout in the street. The SFMTA Traffic Engineer reserves the right to require an inspection for approval prior to marking the layout with temporary tape.

## 6.4 Permanent Pavement Marking Restoration

Restoration of permanent roadway striping damaged during utility excavation must be by the SFMTA Paint Shop. The contractor must submit the following documents to [trafficpermits@sfmta.com](mailto:trafficpermits@sfmta.com) with the subject line "Pavement Restoration":

1. Completed Pavement Restoration/Restriping Request Form:

[https://www.sfmta.com/sites/default/files/reports-and-documents/2021/02/pavement\\_restoration-restriping\\_request\\_form\\_3\\_3.pdf](https://www.sfmta.com/sites/default/files/reports-and-documents/2021/02/pavement_restoration-restriping_request_form_3_3.pdf)

2. Plan showing the street, the location and details of striping requiring restoration: Use an SFMTA Striping Drawing as a base (available at [www.sfmta.com/striping](http://www.sfmta.com/striping)), or another source if no Striping Drawing is available, and show:
  - a. Streets requiring restoration (with street and cross-street names labelled). Include the entire block in which restoration is required.
  - b. Roadway Striping (Show the dimensions (in feet) and types of all pavement marking requiring restoration on each street.
3. Photos of streets requiring striping restoration. Mark up photos with pavement marking types and locations.

The Contractor should install temporary markings for damaged and/or missing striping using temporary tape (as specified in section 6.2.1). SFMTA will prepare an invoice for striping restoration and e-mail to contractor. The Contractor should follow-up with SF Public Works after payment for invoice.

## **6.5 Muni Markings**

The Contractor is responsible for taking inventory of all Muni markings in the work area before doing any work. Markings include yellow “Coach Stop” bars painted on the pavement, yellow “pole stop” bands painted on the sign poles or utility poles, and yellow “breaker marking” dots painted on the pavement. If any Muni marking is damaged or paved over, the Contractor must immediately email [constructionrequest@sfmta.com](mailto:constructionrequest@sfmta.com) so that the SFMTA Paint Shop will restore the markings. If any pole with a yellow “pole stop” band is removed from its location, the Contractor must not install that same pole at a different location without first removing the yellow band. If any pole with a yellow “pole stop” band is replaced with a new pole, the Contractor must notify Muni Service Planning at [constructionrequest@sfmta.com](mailto:constructionrequest@sfmta.com) immediately after the new pole is installed.

## Section 7: TRANSIT OPERATIONS

Contractor shall not delay the operation of any mass transit vehicle at any time, including all Municipal Railway (Muni) vehicles, Golden Gate Transit buses, SamTrans buses, etc. In particular, the Contractor must familiarize himself/herself with the routes of Muni transit lines that operate within the limits of the construction.

### 7.1 Bus Stops

- The Contractor shall not block or impede bus movements into and out of any bus stop, including any bus zone, boarding island, bus bulb, and flag stop.
- The Contractor shall request authorization from the Superintendent of Special Events and Construction by emailing [constructionrequest@sfmta.com](mailto:constructionrequest@sfmta.com) for any work that may interfere with any existing passenger loading and unloading operation at least ten 10 days in advance of said work.
- In certain cases, SFMTA may authorize the temporary relocation of bus zones if requested at least 10 days in advance. Fees may apply. If tow-away is required to reserve space for a relocated bus zone, a Special Traffic Permit will be required. If a bus stop is required to be relocated, SFMTA may require the Contractor to temporarily (if adequate space is available) install a temporary bench for the convenience of elderly and disabled passengers.
- The Contractor shall provide and continuously maintain at least one sign at any bus stop that SFMTA has authorized to be closed or relocated, and at the new bus stop location. Additional signs in language other than English may be required if translation is deemed necessary. The signs are as shown in the Appendix E. The SFMTA Inspector will supply the exact wording and location of these signs.
- Unauthorized bus zone relocations or any other unauthorized use of the temporary bus stop signs will result in fines of up to \$5,000 per incident.

Contractor shall obtain pre-approval of a site plan by SFMTA's Bus Stop Coordinator & Accessibility Section by emailing [mobilityoptions@sfmta.com](mailto:mobilityoptions@sfmta.com) or calling 415-646-2260 for any permanent change that will impact Muni passenger loading/unloading operations, especially the deployment of the wheelchair lift.

### 7.2 Overhead Wires

Contractor is responsible for ensuring that trolley buses reach the overhead trolley wires when going around the work area.

- Muni overhead electric wires carry a minimum of 600 volts DC and have

17.6 feet +/- vertical clearance from the roadway.

- CAL OSHA and CPUC General Order 95 regulations require that any boom type equipment that moves vertically must maintain a 10 feet radial clearance and any other equipment must maintain a six (6) foot clearance from Muni overhead wires.
- The Contractor must adapt the Contractor's method and equipment to this condition, and must take precautions against accidents and damage to the overhead wires and feeder cables when performing paving, base repair, sewer installation works with lines and feeder energized.
- The lanes made available for traffic shall be located so as to include an adequate and allowable travel path for the coach lines. The extreme touring range of the centerline of a trolley coach is 10 feet from the centerline of the trolley wires. The Contractor shall provide a 45-foot turning radius for Municipal Railway vehicles.

For additional information regarding overhead wires see the link below:  
<http://www.sfmta.com/permits/muni-construction-support-and-clearance-permit>

### 7.3 Passenger Facilities

- Passenger Shelters - Contractors shall contact SFMTA's Passenger Shelter providers [Lisa.Ising@sfmta.com](mailto:Lisa.Ising@sfmta.com) (415-530-3638), Margeaux Casillas at [MargeauxCasillas@clearchannel.com](mailto:MargeauxCasillas@clearchannel.com) (510-446-7200 extension 67259), and Ashley Kirchner at [ashleykirchner.ncs@comcast.net](mailto:ashleykirchner.ncs@comcast.net) (707-207-5209) to coordinate the removal and reinstallation of any passenger shelter that is impacted by construction activities. Contractor shall be responsible for restoration of electrical power, telephone service and the sidewalk to pre-construction condition.
- Bus Stop Signage – Contractor shall contact the SFMTA Sign Shop at 415.401.3765 to coordinate the removal and reinstallation of any Muni bus stop signs impacted by construction activities.

### 7.4 Tracks

Contractor must obtain a clearance permit from SFMTA Transit Management Center **before** performing any work within 72 inches of the outside edge of SFMTA track (the "Safety Envelope"). If workers will be within the Safety Envelope, the Contractor shall comply with and train its workers per the SFMTA Rail Safety Training program, in addition to obtaining a clearance permit. Please use link below to start the application process:

<http://www.sfmta.com/permits/muni-construction-support-and-clearance-permit>

- If workers will be within the safety envelope, the Contractor shall comply with and train its workers per the SFMTA Rail Safety Training program

before starting any work, in addition to obtaining a clearance permit. Contact the SFMTA by emailing [roadwayworkerprotection@sfmta.com](mailto:roadwayworkerprotection@sfmta.com) for training requirements.

- Rail Clearance Permit applications must be submitted by the first or third Wednesday of the month prior to the requested work week (starts Saturday) or at least 72 hours in advance of the date needed. The permits are valid up to one week so the Contractor must apply for the permit weekly.
- After a valid Clearance Permit is obtained, the Contractor shall call SFMTA Transit Management Center at 415.565.3137 every day before work begins and when the work has been completed for that day.
- The Contractor shall attend Rail Clearance meetings to provide progress updates to SFMTA staff and work out any issues regarding working near the Muni Rails. Meetings occur twice every month. Please email [constructionrequest@sfmta.com](mailto:constructionrequest@sfmta.com) for meeting dates and locations.

## **Section 8: SCHOOL ZONES**

Additional care should be taken to ensure safety of school children and their “safe passage” to and from school sites. This includes all school crossings and all streets within posted school zones. This is particularly critical during the arrival time and departure times at a construction-impacted school site/zone. Additional flaggers may be required for this purpose.

The Contractor shall give advance notice of construction activities to the school principal and administration at any adjacent school. The Contractor is responsible for making arrangements with the school officials to maintain all school bus loading zones and passenger loading zones.



## **Section 9: BICYCLE ROUTES**

### **9.1 Bike Paths (Class 1)**

Construction on off-street bike paths shall provide an alternate route for bicyclists either by use of an alternate paved path or a temporary bike lane on the street. Any re-routing of bicyclists from an off-street path requires a special traffic permit (STP).

### **9.2 Bike Lanes (Class 2)**

Contractor shall maintain all existing bike lanes. During construction, temporary bike lanes may be delineated by cones but at no time shall the clear width of a bike lane be less than 5 feet. Any bike lane that is effectively narrowed below 5 feet is considered a bike lane closure.

The Contractor shall maintain a clear and clean path of travel for bicyclists at all times. For Further instructions on housekeeping requirements, refer to San Francisco Public Works Municipal Code.

Bike lanes may be closed but only with an approved Special Traffic Permit or City Contract Specifications. An approved STP may require that additional bike signs such as “Bicyclists Allowed Use of Full Lane” or “Bicycle Route Detour” signs be posted as part of the conditions of the permit (see signs in Appendix E).

### **9.3 Bike Routes (Class 3)**

Certain streets on the bicycle route network may not have painted bicycle lanes but are nonetheless important because they provide connectivity to the rest of the network. In particular some bike routes allow bicycles to travel side-by-side with cars in the same lane. These streets are identified as having wide right-hand curb lanes. A curb lane is measured from the curb to the nearest lane line. Wide curb lanes are those that are 22 feet or more in width on streets with parking, or 14 feet or more on streets without parking.

The Contractor should maintain these widths wherever possible. If a wide curb lane will be affected during construction, the Contractor shall post a “Bicycles May Use Full Lane” (R4-11) sign at the beginning of the block, and / or a “Bicycle Route Detour” sign with the legend “⚡ BIKE LANE” at the point where there is room enough to provide a separate bike lane see signs in Appendix E).

### **9.4 Closure of Bike Routes**

A Special Traffic Permit is required for any street closure or the closure of one direction of a street. The STP may require that a bicycle route detour be provided and that additional bike signs such as “Bicyclists Allowed Use of Full Lane” or “Bicycle Route Detour” signs be posted as a permit condition (see signs in Appendix E).

## **Section 10: TRAFFIC CONTROL BY SAN FRANCISCO OFFICERS (SFMTA OR SFPD)**

Traffic Control by Uniformed San Francisco Municipal Transportation Agency Parking Control Officers or by San Francisco Police Officers assigned to work 10B Construction (both referred to herein as officers) may be required under certain circumstances, such as a Special Traffic Permit or Contract specifications. The decision to use parking control officers or police officers, or both, will be dependent upon duties and availability.

### **10.1 Duties of Officers**

- Direct vehicular and pedestrian traffic
- Cite motorists or pedestrians violating traffic regulations
- Maintain contractor compliance with STP conditions
- Enforce traffic regulations
- Facilitate safe paths of travel
- Other traffic control duties as directed by SFMTA

Additional officer duties will be specified in the Special Traffic Permit, Traffic Control Plan or in the city contract specifications.

### **10.2 Requesting Officers**

#### **Parking Control Officer (PCO)**

If the permit engineer or traffic engineer requires PCOs the engineer will schedule the PCOs based on the requirements of the permit or specification. SFMTA requires a minimum of 14 calendar days to schedule PCO support. For San Francisco capital projects the project may send funds to SFMTA to pay for their support. For other projects the SFMTA Enforcement Division will bill the Contractor directly.

#### **Police Officer (SFPD)**

If the permit engineer or traffic engineer requires SFPD the Contractor shall coordinate deployment of officers with the San Francisco Police District Construction Coordinator, Officer Edwin Gaffud at 415-215-5315 or at [edwin.gaffud@sfgov.org](mailto:edwin.gaffud@sfgov.org). SFPD requires a minimum of 14 calendar days to schedule officer support. The Contractor shall make a deposit to the SFPD in the amount of \$2,000 unless otherwise specified by the SFPD. The Contractor shall pay SFPD each invoice within 30 calendar days of the invoice date.

### **10.3 Officer Working Hours**

The officers shall be paid a minimum of four hours per day. If the number of work hours exceeds four hours, the officers shall be paid for one additional hour for travel time. For a twelve-hour shift, the officers shall be paid thirteen hours per ordinance.

### **10.4 Notification and Restrictions**

#### **Parking Control Officer (PCO)**

The Contractor shall notify SFMTA Enforcement at [pcosupport@sfmta.com](mailto:pcosupport@sfmta.com) and the traffic engineer if there are schedule changes or cancellation. The minimum time to cancel is 24 hours; if less notice is given the Contractor will be billed a minimum of 4 hours per scheduled officer.

### **Police Officer (SFPD)**

The Contractor shall notify the San Francisco Police District Construction Coordinator Officer Edwin Gaffud at 415-215-5315 or at [edwin.gaffud@sfgov.org](mailto:edwin.gaffud@sfgov.org) regarding the schedule and number of officers required at least 4 calendar days in advance of the scheduled date. The minimum time to cancel is 24 hours; if less notice is given the Contractor will be billed a minimum of 4 hours per scheduled officer.

### **10.5 Furnishing Permits to Officers**

Each day the Contractor shall furnish each officer a copy of the STP (if one is issued) before beginning work at the site to ensure that the officers are familiar with the conditions on the permit. Failure to furnish all officers copies of the permit may result in the officers canceling the job, thereby placing the contractor in violation of the permit.

### **10.6 Officer Reassignment**

SFMTA and SFPD reserve the right to re-assign officers to other duties, in case of emergencies. SFMTA and SFPD may adjust the number of officers at a site based on site conditions.

## **Section 11: DETECTORS IN CITY STREETS**

### **11.1 Vehicle Detectors in the Work Area**

The SFMTA maintains vehicular detector loops at certain signalized intersections. Detector loops are usually marked with rectangular or circular saw-cuts in the pavement, just before the crosswalk line. The loops are usually located within the first four (4) inches of the roadway surface. The Contractor is responsible for making sure that these facilities are not damaged. If these loops are within the work area and could be damaged or affected, the Contractor should follow the procedure below:

- The Contractor shall notify SFMTA Signal Shop at 415.401.3700, 48 hours *before* starting work.
- The Contractor shall obtain a copy of the loop detector plan from SFMTA by emailing [trafficpermits@sfmta.com](mailto:trafficpermits@sfmta.com)
- At the Contractor's expense, the SFMTA Signal Shop will disconnect wired vehicle detectors prior to the Contractor starting work
- The Contractor shall repair and restore the wired loops, at the Contractor's expense, within seven days of roadway restoration at the site.
- The Contractor shall notify the SFMTA Signal Shop as soon as the wired loop is re-installed for inspection.

### **11.2 Vehicle Sensors in the Work Area**

The SFMTA maintains wireless vehicular sensors at certain signalized intersections. Sensors are shown on the pavement by circular black epoxy dots. The Contractor is responsible for making sure that these facilities are not damaged. If these sensors are within the work area and could be damaged or affected, the Contractor should follow the procedure below:

- The Contractor shall notify SFMTA Signal Shop at 415.401.3700, 48 hours before starting work.
- The Contractor shall obtain a copy of the wireless/loop detector plan from SFMTA by emailing [trafficpermits@sfmta.com](mailto:trafficpermits@sfmta.com).
- At the Contractor's expense, the SFMTA Signal Shop will remove wireless vehicle detectors prior to the Contractor starting work and re-install the detectors after work is completed.

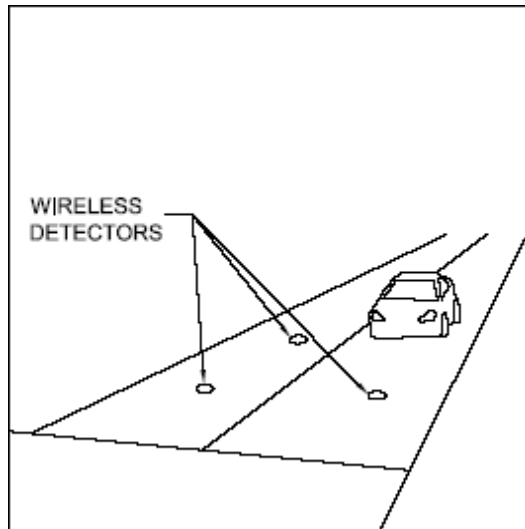

**Figure 2:** Wireless Detector Schematic

In the field, detectors look like black epoxy dots, approximately four (4) inches in diameter. The Contractor shall notify the SFMTA Signal Shop if it is suspected a detector could be within the work area.

### 11.3 Bicycle Counter Detectors in the Work Area

SFMTA maintains automatic bicycle counter loops on certain streets. These loops are marked with diamond saw-cuts in the pavement and are in bike lanes at mid-block and intersection locations. The wired loop counters are installed one (1) to three (3) inches below the road surface.

If these detectors are located within the work area and could be subjected to damage by construction, the Contractor is responsible for coordinating their removal with SFMTA. The Contractor should follow the procedure below:

- A. The Contractor shall notify SFMTA via email at [bikecounters@sfmta.com](mailto:bikecounters@sfmta.com), two (2) working days before starting work.
- B. The Contractor shall deliver one set of the excavation plans to the San Francisco Municipal Transportation Agency at 1 South Van Ness Avenue, 7<sup>th</sup> Floor at least two (2) working days before starting work.
- C. The SFMTA shall send an estimate of the cost of restoring the bike detectors to the Contractor. The Contractor shall send a check for the estimated cost to the SFMTA within 15 working days.
- D. The Contractor shall send confirmation to the SFMTA Livable Streets when the paving has been accepted by the SFPW-BSM Inspector.

### 11.4 Working Around Parking Stall or Roadway Sensors

- If parking stall or roadway sensors are located within the work area and

could be damaged or affected, the Contractor is responsible for the removal and safe handling of these decommissioned sensors. The Contractor shall contact Steve Counts ([Stephen.Counts@sfmta.com](mailto:Stephen.Counts@sfmta.com), 415-550-2779) to coordinate the drop-off of the sensors at the SFMTA Meter Shop at 1508 Bancroft Avenue, San Francisco, CA 94124.

- Wireless detectors shall never be punctured, cut, ground, or removed from solid core. These actions may result in leakage or release of battery contents, explosion, or fire.

### **11.5 Other Traffic-Related Devices in the Work Area**

In addition to having vehicle loop detectors for signals, some intersections in the City have red light cameras or in-pavement flashing devices. The Contractor should follow the procedures described in Section 11.1 “Vehicle Detectors in the Work Area” when encountering these conditions

## Section 12: EMERGENCY PROCEDURE and CONSTRUCTION ZONE STANDARDS

### 12.1 Emergency Procedure

If an emergency arises such as a sewer collapse, essential service interruption or a water main break, the Contractor may deviate from the regulations in this manual. When the Contractor suddenly and unexpectedly finds it necessary to close lanes or walkways to access facilities to preserve life or property or to restore interrupted essential services, the Contractor may begin work before obtaining the necessary permit(s). This may require working through the peak traffic hours in the street. The Contractor may also be required to pay for Police Officers and/or Parking Control Officers in order to maintain any emergency road closure(s).

If the emergency happens during normal business hours the Contractor shall immediately notify the City Agencies listed below and apply for the necessary permit(s) and a Special Traffic Permit within four (4) hours. If the emergency happens outside of normal business hours the Contractor shall immediately notify the City Agencies listed below, and apply for the necessary permit(s) and a Special Traffic Permit within 4 hours after City offices next open if the work will continue into the next business day.

**IN CASE OF EMERGENCY, CONTRACTOR SHALL  
IMMEDIATELY NOTIFY ALL OF THE FOLLOWING CITY  
AGENCIES:**

<b>Agency</b>	<b>Phone Number/Email</b>
<b>SFMTA</b>	
Parking Enforcement Dispatch	415.553.1200
Transportation Engineering	<a href="mailto:trafficpermits@sfmta.com">trafficpermits@sfmta.com</a>
SFMTA/MUNI – Transit Management Center	415.565.3116
<b>San Francisco Public Works (SFPW)</b>	
Bureau of Street-Use and Mapping (BSM)	628.271.2000
<b>San Francisco Police Department</b>	
SFPD Dispatch Center	415.553.0123

### 12.2 Construction Zone Standards

Contractor is responsible for maintaining a safe work area at all times, including after working hours.

#### 12.2.1 Tow-Away Lanes

Contractor is responsible for keeping “Tow-Away No Stopping” traffic lanes clear

during the effective hours posted.

### 12.2.2 Metal Plating

Any temporary metal plating and metal bridging must be coated with a non-skid and rust inhibitive product. Examples of non-skid metal plating are surfaces with waffle- patterns or right angle undulations. Plating must be installed with no edges or corners sticking up and with no bouncing or shifting. Plates must be secured against shifting by tack welding, or fasteners. Any non-skid product must have a friction factor of 0.35 or greater as measured by the California Department of Transportation Test 342. Refer to section 2.4.53 of the San Francisco Public Works Code for further requirements.

### 12.2.3 Transitioning (Ramping)

Whenever the grade difference between the existing pavement and the excavated area is greater than  $\frac{3}{4}$  inch, Contractor must provide longitudinal and transverse transitions prior to opening the lanes to traffic. The maximum slope on these transitions must be 1:18. Transitions must be installed with hot asphalt concrete. This section applies to newly constructed roadway base, manholes, metal plating, bridging, back-filled trenches, etc.

### 12.2.4 Cyclone Fences

Bases of temporary cyclone fences must not extend over any adjacent traffic, bicycle lane, or pedestrian path of travel.

### 12.2.5 Placement of Message and Arrow Boards, and Other Devices

On conventional highways with curbs, typically in urban conditions, a minimum horizontal clearance of 1 foot 6 inches should be provided between an obstruction and the edge of travel way (traffic lane). Whenever a CMS or arrow board is not being used, it must be turned off, placed or stored outside of the clear recovery zone or behind a protective barrier. A clear recovery zone is an unobstructed, traversable roadside area that allows a driver to stop safely or regain control of a vehicle that has left the roadway.

#### Clear Recovery Area

[https://safety.fhwa.dot.gov/roadway\\_dept/countermeasures/safe\\_recovery/clear\\_zones/](https://safety.fhwa.dot.gov/roadway_dept/countermeasures/safe_recovery/clear_zones/)

#### Clearances (Topic 309)

<https://dot.ca.gov/-/media/dot-media/programs/design/documents/chp0300-a11y.pdf>

Caltrans Changeable Message Signs (CMS) Guidelines may be found at:

<https://dot.ca.gov/-/media/dot-media/programs/traffic-operations/documents/mobility/cms-guidelines-april-2021.pdf>





## **Section 13: PENALTIES, CITATIONS AND ADMINISTRATIVE REVIEW**

### **13.1 Safe Paths of Travel (SPOT) Citations**

Penalties may be assessed for violation of the terms of the Special Traffic Permit (STP) and/or the regulations described in this manual, including working without an STP when one is required by this manual or the transportation code. Each hour during which the violation continues shall constitute a separate offense.

### **13.2 Types of Citations**

Any person who violates the regulations described in this manual may be subject to the issuance of a citation and imposition of an administrative penalty. The designated officer or employee may issue a warning (admonishment) or direct corrective action in lieu of the issuance of a citation.

Any person and/or business entity with four or more violations within one year may be deemed guilty of a misdemeanor and upon conviction thereof shall be punished by a fine of at least \$1,000, or imprisonment in the county jail not exceeding six months, or both. Administrative penalties shall not exceed \$1,000 for each offense, with a maximum cumulative penalty not to exceed \$5,000 per day, per violator.-

### **13.3 Payments for Citations**

Citation penalties are due and payable to the SFMTA within 15 business days from the date of the notice, if not contested within the time period specified.

### **13.4 Hearings and Administrative Review for Citations**

A person or entity that has been issued a citation may request administrative review in order to contest the citation issued. Administrative review shall be initiated by filing a request for administrative review with the SFMTA Hearing Division within 15 business days from the date of the citation. To schedule a hearing e-mail [hearingsgeneral@sfmta.com](mailto:hearingsgeneral@sfmta.com).

Whenever administrative review is requested, the SFMTA Hearing Section shall, within fifteen business days of receipt of the request, notify the requestor of the date, time, and place of the administrative hearing. Such hearing shall be held no later than 30 calendar days after the SFMTA Hearing Section receives the request, unless time is extended by mutual agreement of the affected parties.

## REFERENCES

“California Manual on Uniform Traffic Control Devices (CA MUTCD),” State of California, Department of Transportation  
<https://dot.ca.gov/programs/safety-programs/camutcd>

The San Francisco Public Works, Bureau of Street-Use and Mapping, Street Construction Coordination Center, 49 South Van Ness Ave, San Francisco CA 94103  
<https://www.sfpublishworks.org/>

The San Francisco Traffic Code, Division I and II. Relevant sections can be found at [www.sfmta.com/bluebook](http://www.sfmta.com/bluebook) and selecting the link “San Francisco Traffic Code Sections”.

**APPENDIX A: SECTION REMOVED**  
**APPENDIX B: SECTION REMOVED**



**APPENDIX C: STREETS OF MAJOR TRAFFIC IMPORTANCE**



**TABLE 1  
STREETS OF MAJOR IMPORTANCE**

**NO WORK RESULTING IN SHIFTING OR CLOSING TRAFFIC LANES IS ALLOWED ON THE FOLLOWING STREETS DURING THE SPECIFIED HOURS.** Contractor is not allowed to leave any hole, debris, or material/equipment in the traffic lanes, including tow-away lanes, during these hours. **Effective days are Monday thru Friday (unless noted).**

STREETS (Limits)	NORTHBOUND	SOUTHBOUND	EASTBOUND	WESTBOUND	ADDITIONAL RESTRICTIONS SEE APPENDIX D MAPS
1ST ST (Market - Harrison)	--	7am - 9am 3pm - 7pm	--	--	
2ND ST (Folsom - King)	7am - 9am 3pm - 7pm	7am - 9am 3pm - 7pm	--	--	Map 3
3RD ST (Market - King)	7am - 7pm Everyday	--	--	--	Maps 2 & 3
3RD ST (King - Jerrold)	7am - 7pm Everyday	7am - 7pm Everyday	--	--	Map 3
3RD ST (Jerrold - Thornton)	24 HOURS Everyday	24 HOURS Everyday	--	--	
3RD ST (Thornton - Jamestown)	7am - 7pm Everyday	7am - 7pm Everyday	--	--	
4TH ST (Market - Bryant)	--	7am - 7pm Everyday	--	--	Maps 2 & 3
4TH ST (Bryant - Townsend)	--	7am - 9am 3pm - 7pm	--	--	Map 3
4TH ST (Townsend - Channel)	7am - 9am 3pm - 7pm	7am - 9am 3pm - 7pm	--	--	Map 3
5TH ST (Market - Brannan)	7am - 7pm Everyday	7am - 7pm Everyday	--	--	
6TH ST (Market - Brannan)	7am - 7pm Everyday	7am - 7pm Everyday	--	--	
7TH AVE (Laguna Honda - Lincoln)	7am - 9am 3pm - 7pm	7am - 9am 3pm - 7pm	--	--	Map 3
7TH ST (16th - Brannan)	7am - 9am 3pm - 7pm	7am - 9am 3pm - 7pm	--	--	
7TH ST (Brannan - Market)	7am - 9am 3pm - 7pm	--	--	--	
7TH ST (Market - McAllister)	7am - 9am 3pm - 7pm	7am - 9am 3pm - 7pm	--	--	
8TH ST (Market - Brannan)	--	7am - 9am 3pm - 7pm	--	--	
8TH ST (Brannan – 125' South)	7am - 9am 3pm - 7pm	7am - 9am 3pm - 7pm	--	--	
9TH ST (Division - Brannan)	7am - 9am 3pm - 7pm	7am - 9am 3pm - 7pm	--	--	
9TH ST (Brannan - Bryant)	7am - 9am 3pm - 7pm	--	--	--	
9TH ST (Bryant - Market)	7am - 7pm Everyday	--	--	--	
10TH ST (Market - Brannan)	--	7am - 7pm Everyday	--	--	
11TH ST (Mission – 13th)	7am - 9am 3pm - 7pm	7am - 9am 3pm - 7pm	--	--	
13TH ST (Mission - So. Van Ness)	--	--	7am - 7pm Everyday	7am - 7pm Everyday	
13TH ST (So. Van Ness - Potrero)	--	--	7am - 9am 3pm - 7pm	7am - 9am 3pm - 7pm	
14TH ST (Castro - Folsom)	--	--	7am - 9am 3pm - 7pm	--	

STREETS (Limits)	NORTHBOUND	SOUTHBOUND	EASTBOUND	WESTBOUND	ADDITIONAL RESTRICTIONS SEE APPENDIX D MAPS
16TH ST (Market - Church)	--	--	7am - 9am	4pm - 6pm	
16TH ST (Church - 3rd)	--	--	7am - 9am 4pm - 7pm	4pm - 7pm	Map 3
17TH ST (Church - Noe)	--	--	--	4pm - 6pm	
17TH ST (Noe - Diamond)	--	--	7am - 9am	4pm - 6pm	
17TH ST (Roosevelt - Stanyan)	--	--	7am - 9am	4pm - 6pm	
18TH ST (Market - Harrison)	--	--	7am - 9am	4pm - 6pm	
19TH AVE (Lincoln - J. Serra)	7am - 7pm Everyday	7am - 7pm Everyday	--	--	Caltrans Jurisdiction
25TH AVE (Clement - Anza)	7am - 9am 4pm - 6pm	7am - 9am 4pm - 6pm	--	--	
25TH AVE (Cabrillo - Fulton)	--	4pm - 7pm	--	--	
36TH AVE (Irving - Lincoln)	4pm - 7pm	--	--	--	
37TH AVE (Lincoln - Irving)	--	4pm - 7pm	--	--	
Alemany Blvd (Ocean - Bayshore)	--	--	4pm - 7pm	4pm - 7pm	Caltrans Juris. (under US101)
Balboa St (Arguello - 14th Ave)	--	--	7am - 9am 4pm - 7pm	4pm - 6pm 4pm - 7pm	
Battery St (Market - Broadway)	--	7am - 7pm Everyday	--	--	
Battery St (Broadway - Embarcadero)	--	7am - 9am 3pm - 7pm	--	--	
Bay St (Embarcadero - Kearny)	--	--	7am - 9am	4pm - 6pm	
Bay St (Kearny - Powell)	--	--	7am - 9am 4pm - 7pm	4pm - 6pm	
Bay St (Powell - Laguna)	--	--	7am - 9am	4pm - 6pm	
Bayshore Blvd (Cesar Chavez - Silver)	7am - 9am 4pm - 7pm	4pm - 7pm	--	--	
Bayshore Blvd (Silver - Fitzgerald)	7am - 9am 4pm - 6pm	4pm - 6pm	--	--	
Bayshore Blvd. (Fitzgerald – Hester On-Ramp)	7am - 9am	4pm - 6pm	--	--	
Bayshore Blvd. (Hester On-Ramp - Arleta)	7am - 9am 4pm - 7pm	4pm - 6pm	--	--	
Bayshore Blvd. (Arleta - County Line)	7am - 9am 4pm - 7pm	4pm - 7pm	--	--	
Beach St (Laguna - Buchanan)	7am - 9am 4pm - 6pm	7am - 9am 4pm - 6pm	--	--	
Beach St (Jones - Embarcadero)	4pm - 7pm	4pm - 7pm	--	--	
Beale St (Market - Folsom)	--	7am - 9am 3pm - 7pm	--	--	
Beale St (Folsom - Bryant)	7am - 9am 3pm - 7pm	7am - 9am 3pm - 7pm	--	--	
Bosworth St (Congo – Arlington)	--	--	4pm - 7pm	4pm - 7pm	

STREETS (Limits)	NORTHBOUND	SOUTHBOUND	EASTBOUND	WESTBOUND	ADDITIONAL RESTRICTIONS SEE APPENDIX D MAPS
<b>Brannan St</b> (Embarcadero - 10th St)	--	--	7am - 9am 3pm - 7pm	7am - 9am 3pm - 7pm	
<b>Broadway</b> (Embarcadero - Powell)	--	--	7am - 9am 3pm - 7pm (Mon-Fri) 2pm - 7pm (Sat-Sun)	7am - 9am 3pm - 7pm (Mon-Fri) 2pm - 7pm (Sat-Sun)	
<b>Broadway Tunnel</b> (Powell - Larkin)	--	--	7am - 7pm Mon-Sat	7am - 7pm Mon-Sat	
<b>Broadway</b> (Larkin - Gough)	--	--	7am - 9am 3pm - 7pm	7am - 9am 3pm - 7pm	
<b>Brotherhood Way</b> (Lake Merced - Alemany)	--	--	7am - 9am 3pm - 7pm	7am - 9am 3pm - 7pm	
<b>Bryant St</b> (11th St – Sterling)	--	--	--	7am - 9am 3pm - 7pm	Map 3
<b>Bryant St</b> (Sterling - Embarcadero)	--	--	7am - 9am 3pm - 7pm	7am - 9am 3pm - 7pm	
<b>Bush St</b> (Presidio - Gough)	--	--	7am - 10am	--	
<b>Bush St</b> (Gough - Taylor)	--	--	7am - 10am 3pm - 7pm	--	
<b>Bush St</b> (Taylor - Battery)	--	--	7am - 7pm Everyday	--	
<b>California St</b> (Market - 2nd Av.)	--	--	7am - 9am 3pm - 7pm	7am - 9am 3pm - 7pm	
<b>California St</b> (12th Av.- 14th Av.)	--	--	7am - 9am 4pm - 7pm	7am - 9am 4pm - 7pm	
<b>Castro St</b> (Waller - Market)	7am - 9am 4pm - 7pm	7am - 9am 4pm - 7pm	--	--	
<b>Castro St</b> (17th St - 18th St)	7am - 6pm	7am - 6pm	--	--	
<b>Cesar Chavez</b> (3rd St - Dolores)	--	--	7am - 9am 3pm - 7pm	7am - 9am 3pm - 7pm	Map 3
<b>Chestnut St</b> (Fillmore - Broderick)	--	--	4pm - 6pm	4pm - 6pm	
<b>Church St</b> (Duboce - 18th St)	7am - 9am 4pm - 7pm	4pm - 7pm	--	--	
<b>Church St</b> (22nd St - 30th St)	4pm - 7pm	4pm - 7pm	--	--	
<b>Clay St</b> (Drumm - Sansome)	--	--	7am - 9am 3pm - 7pm	--	
<b>Clay St</b> (Sansome - Kearny)	--	--	7am - 7pm	--	
<b>Clay St</b> (Kearny - Van Ness)	--	--	7am - 9am 3pm - 7pm	--	
<b>Clay St</b> (Van Ness - Gough)	--	--	7am - 9am 3pm - 7pm	7am - 9am 3pm - 7pm	
<b>Clayton St</b> (Twin Peaks - Ashbury)	7am - 9am	4pm - 6pm	--	--	
<b>Clipper St</b> (Portola – Grand View)	--	--	4pm - 7pm	4pm - 7pm	
<b>Columbus Ave</b> (Montgomery - Vallejo)	--	--	7am - 9am 3pm - 7pm	7am - 9am 3pm - 7pm	
<b>Columbus Ave</b> (Vallejo - North Point)	--	--	7am - 9am 4pm - 7pm	4pm - 7pm	
<b>Crossover Drive</b> (Lincoln - Park Presidio Bypass)	7am - 7pm Everyday	7am - 7pm Everyday	--	--	Caltrans Jurisdiction



STREETS (Limits)	NORTHBOUND	SOUTHBOUND	EASTBOUND	WESTBOUND	ADDITIONAL RESTRICTIONS SEE APPENDIX D MAPS
<b>Crossover</b> (Park Presidio Bypass – Fulton / 25th)	--	--	4pm - 7pm	--	
<b>Cyril Magnin St</b> (Market - Eddy)	7am - 9am 3pm - 7pm	7am - 9am 3pm - 7pm	--	--	
<b>Cyril Magnin St</b> (Eddy - Ellis)	7am - 9am 3pm - 7pm	--	--	--	
<b>Davis St</b> (Market - Washington)	--	7am - 9am 3pm - 7pm	--	--	
<b>Dewey Blvd.</b> (Taraval - Laguna Honda)	--	--	7am - 9am	4pm - 6pm	
<b>Diamond St</b> (Bosworth - Monterey)	7am - 9am 4pm - 6pm	7am - 9am 4pm - 6pm	--	--	
<b>Divisadero St</b> (Waller - California)	7am - 9am 4pm - 7pm	4pm - 7pm	--	--	
<b>Divisadero St</b> (California - Sacramento)	4pm - 7pm	4pm - 7pm	--	--	
<b>Division St</b> (11th St - Potrero)	--	--	7am - 9am 3pm - 7pm	7am - 9am 3pm - 7pm	
<b>Division St</b> (Potrero - De Haro)	--	--	--	7am - 9am 3pm - 7pm	
<b>Dolores St</b> (Market - San Jose)	7am - 9am	3 pm - 7pm	--	--	
<b>Dr. Carlton B. Goodlet Pl.</b> (Grove – McAllister)	See Polk St.	See Polk St.	--	--	
<b>Drumm St</b> (Market - Washington)	7am - 9am 3pm - 7pm	7am - 9am 3pm - 7pm	--	--	
<b>Duboce Ave</b> (Church - Noe)	--	--	4pm - 7pm	4pm - 7pm	
<b>Duboce Ave</b> (Mission - Market)	--	--	7am - 9am 3pm - 7pm	7am - 9am 3pm - 7pm	
<b>Eddy St</b> (Leavenworth - Mason)	--	--	7am - 9am 3pm - 7pm	4pm - 7pm	
<b>Eddy St</b> (Mason – Cyril Magnin)	--	--	7am - 9am 3pm - 7pm	--	
<b>Ellis St</b> (Gough – Polk)	--	--	--	7am - 9am 3pm - 7pm	
<b>Ellis St</b> (Polk – Larkin)	--	--	7am - 9am 3pm - 7pm	7am - 9am 3pm - 7pm	
<b>Ellis St</b> (Jones – Stockton)	--	--	--	7am - 9am 3pm - 7pm	
<b>Embarcadero</b> (King - North Point)	7am - 7pm Everyday	7am - 7pm Everyday	--	--	Port Jurisdiction
<b>Embarcadero</b> (North Point - Taylor)	--	--	7am - 7pm Everyday	7am - 7pm Everyday	Port Jurisdiction
<b>Essex St</b> (Folsom - Harrison)	--	7am - 9am 3pm - 7pm	--	--	
<b>Euclid Ave</b> (Presidio - Masonic)	--	--	7am - 9am	--	
<b>Evans Ave</b> (Cesar Chavez - Jennings)	--	--	4pm – 7pm	4pm – 7pm	
<b>Fell St</b> (Polk - Van Ness)	--	--	7am - 7pm Everyday	--	
<b>Fell St</b> (Van Ness - Gough)	--	--	7am - 7pm Everyday	7am - 7pm Everyday	
<b>Fell St</b> (Gough - Stanyan)	--	--	--	7am - 7pm Everyday	

STREETS (Limits)	NORTHBOUND	SOUTHBOUND	EASTBOUND	WESTBOUND	ADDITIONAL RESTRICTIONS SEE APPENDIX D MAPS
<b>Fillmore St</b> (Chestnut - Lombard)	4pm - 6pm	4pm - 7pm	--	--	
<b>Folsom St</b> (Cesar Chavez - 15th St)	7am - 9am	4pm - 6pm	--	--	
<b>Folsom St</b> (15th St - 13th St)	7am - 9am 4pm - 7pm	4pm - 6pm	--	--	
<b>Folsom St</b> (13th St - 11th St)	--	--	7am - 9am 3pm - 7pm	7am - 9am 3pm - 7pm	
<b>Folsom St</b> (11th St - 2nd St)	--	--	7am - 9am 3pm - 7pm	--	Map 2
<b>Folsom St</b> (2nd St - Embarcadero)	--	--	7am - 9am 3pm - 7pm	7am - 9am 3pm - 7pm	
<b>Franklin St</b> (Market - California)	7am - 7pm Everyday	--	--	--	
<b>Franklin St</b> (California - Lombard)	7am - 9am 3pm - 7pm	--	--	--	
<b>Fremont St</b> (Market - I-80 Folsom Off-Ramp)	7am - 9am 3pm - 7pm	--	--	--	
<b>Fremont St</b> (I-80 Folsom Off-Ramp - Harrison)	7am - 9am 3pm - 7pm	7am - 9am 3pm - 7pm	--	--	
<b>Frida Khalo Way</b> (Ocean – Phelan Loop)	4pm - 7pm	4pm - 7pm	--	--	
<b>Front St</b> (Market - Clay)	7am - 9am 3pm - 7pm	--	--	--	
<b>Front St</b> (Jackson - Broadway)	7am - 9am 3pm - 7pm	7am - 9am 3pm - 7pm	--	--	
<b>Fulton St</b> (Hyde - Gough)	--	--	7am - 9am 3pm - 7pm	7am - 9am 3pm - 7pm	
<b>Fulton St</b> (Gough - Shrader)	--	--	7am - 9am	4pm - 6pm	
<b>Fulton St</b> (Shrader – 25th Ave)	--	--	7am - 9am 4pm - 7pm	4pm - 7pm	
<b>Fulton St</b> (25th Ave – La Playa)	--	--	4pm - 7pm	4pm - 7pm	
<b>Geary St</b> (Market - Taylor)	--	--	--	7am - 7pm Everyday	
<b>Geary St</b> (Taylor - Gough)	--	--	--	7am - 9am 3pm - 7pm	
<b>Geary Blvd.</b> (Gough - Webster)	--	--	7am - 9am 3pm - 7pm	3pm - 7pm	
<b>Geary Blvd. Underpass</b> (Webster - Steiner)	--	--	7am - 7pm	7am - 7pm	
<b>Geary Blvd. Surface Road</b> (Webster - Steiner)	--	--	4pm - 7pm	4pm - 7pm	
<b>Geary Blvd.</b> (Steiner - Lyon)	--	--	7am - 9am 3pm - 7pm	3pm - 7pm	
<b>Geary Blvd. Underpass</b> (Lyon - Wood)	--	--	7am - 7pm	7am - 7pm	
<b>Geary Blvd. Surface Road</b> (Presidio - Masonic)	--	--	3pm - 7pm	3pm - 7pm	
<b>Geary Blvd.</b> (Wood - 25th Ave)	--	--	7am - 7pm	7am - 7pm	
<b>Geary Blvd.</b> (25th Ave - 41st Ave)	--	--	4pm - 7pm	4pm - 7pm	
<b>Geneva Ave</b> (Schwerin - Santos)	--	--	4pm - 7pm	4pm - 7pm	Daly City Jurisdiction

STREETS (Limits)	NORTHBOUND	SOUTHBOUND	EASTBOUND	WESTBOUND	ADDITIONAL RESTRICTIONS SEE APPENDIX D MAPS
<b>Geneva Ave</b> (Santos - Paris)	--	--	4pm - 7pm	4pm - 7pm	
<b>Geneva Ave</b> (Paris - Ocean)	--	--	7am - 9am 4pm - 7pm	7am - 9am 4pm - 7pm	
<b>Gilman St</b> (3 <sup>RD</sup> St – Giants Drive)	--	--	4pm - 7pm	4pm - 7pm	
<b>Golden Gate Ave</b> (Divisadero - Market)	--	--	7am - 9am 3pm - 7pm	--	
<b>Gough St</b> (Lombard - Clay)	--	7am - 9am 3pm - 7pm	--	--	
<b>Gough St</b> (Clay - Sacramento)	7am - 9am 3pm - 7pm	7am - 9am 3pm - 7pm	--	--	
<b>Gough St</b> (Sacramento - Grove)	--	7am - 9am 3pm - 7pm	--	--	
<b>Gough St</b> (Grove - Market)	--	7am - 7pm Everyday	--	--	
<b>Gough St</b> (Market - Otis)	--	7am - 9am 3pm - 7pm	--	--	
<b>Grant Ave</b> (Market - Geary)	7am - 7pm Mon-Sat	--	--	--	
<b>Grant Ave</b> (Geary - Bush)	7am - 7pm Mon-Sat	7am - 7pm Mon-Sat	--	--	
<b>Grant Ave</b> (Bush - Broadway)	7am - 7pm Mon-Sat	--	--	--	
<b>Grove St</b> (Hyde - Polk)	--	--	--	7am - 9am 3pm - 7pm	
<b>Grove St</b> (Polk - Gough)	--	--	7am - 9am 3pm - 7pm	7am - 9am 3pm - 7pm	
<b>Guerrero St</b> (Market - Duboce)	7am - 9am 3pm - 7pm	7am - 9am 3pm - 7pm	--	--	
<b>Guerrero St</b> (Duboce - Cesar Chavez)	7am - 9am	4pm - 6pm	--	--	
<b>Guerrero St</b> (Cesar Chavez - San Jose)	7am - 9am 4pm - 6pm	7am - 9am 4pm - 6pm	--	--	
<b>Haight St</b> (Stanyan - Central)	--	--	7am - 9am 4pm - 6pm	4pm - 6pm	
<b>Haight St</b> (Buchanan - Gough)	--	--	4pm - 7pm	4pm - 7pm	
<b>Harrison St</b> (Embarcadero - 3rd St)	--	--	7am - 9am 3pm - 7pm	7am - 9am 3pm - 7pm	
<b>Harrison St</b> (3 <sup>rd</sup> St - 10th St)	--	--	--	7am - 9am 3pm - 7pm	Map 2
<b>Harrison St</b> (10 <sup>th</sup> St - 13th St)	--	--	7am - 9am 3pm - 7pm	7am - 9am 3pm - 7pm	
<b>Harrison St</b> (13th St - 16th St)	4pm - 6pm	4pm - 6pm	--	--	
<b>Hawthorne St</b> (Howard - Harrison)	--	7am - 9am 3pm - 7pm	--	--	
<b>Hayes St</b> (Market - Van Ness)	--	--	--	7am - 7pm Everyday	
<b>Hayes St</b> (Van Ness - Gough)	--	--	7am - 7pm Everyday	7am - 7pm Everyday	
<b>Howard St</b> (Beale - 11th St)	--	--	--	7am - 9am 3pm - 7pm	Map 2
<b>Howard St</b> (11th St - 12th St)	--	--	7am - 9am 3pm - 7pm	7am - 9am 3pm - 7pm	

STREETS (Limits)	NORTHBOUND	SOUTHBOUND	EASTBOUND	WESTBOUND	ADDITIONAL RESTRICTIONS SEE APPENDIX D MAPS
Hyde St (Broadway - California)	7am - 9am 3pm - 7pm	7am - 9am 3pm - 7pm	--	--	
Hyde St (California - Market)	--	7am - 9am 3pm - 7pm	--	--	
Industrial St (Bayshore – Palou)	--	--	4pm - 7pm	4pm - 7pm	
Jackson St (Gough - Van Ness)	--	--	--	4pm - 7pm	
Jackson St (Van Ness - Larkin)	--	--	--	7am - 9am 3pm - 7pm	
Jefferson St (Embarcadero - Hyde)	--	--	11am - 7pm Everyday	11am - 7pm Everyday	
Jones St (Jefferson – Beach)	--	--	4pm - 7pm	4pm - 7pm	
Jones St (California – Golden Gate)	--	--	--	7am - 9am 3pm - 7pm	
Judah St (3rd Ave - 9th Ave)	--	--	7am - 9am 4pm - 6pm	7am - 9am 4pm - 6pm	
Judah St (9th Ave - 19th Ave)	--	--	7am - 9am 4pm - 7pm	7am - 9am 4pm - 7pm	
Judah St (19th Ave – Lower Great Highway)	--	--	4pm - 7pm	4pm - 7pm	
Junipero Serra (St Francis - Ocean)	7am - 7pm	7am - 7pm	--	--	
Junipero Serra (Ocean – 19th Ave)	7am - 9am 4pm - 7pm	7am - 9am 4pm - 7pm	--	--	
Junipero Serra (19th Ave - I-280)	7am - 7pm Everyday	7am - 7pm Everyday	--	--	Caltrans Jurisdiction
Kearny St (Market - California)	7am - 7pm Everyday	--	--	--	
Kearny St (California - Columbus)	7am - 9am 3pm - 7pm	--	--	--	
Kearny St (Columbus - Broadway)	7am - 9am 3pm - 7pm	7am - 9am 3pm - 7pm	--	--	
Kezar Dr. (Stanyan - Lincoln Wy)	7am - 7pm Everyday	7am - 7pm Everyday	--	--	
King St (Embarcadero - 5th St)	--	--	7am - 9am 3pm - 7pm	7am - 9am 3pm - 7pm	Map 3
Laguna St (Bay - Marina)	4pm - 7pm	7am - 9am 4pm - 7pm	--	--	
Laguna Honda (7th Ave - Dewey)	7am - 9am 4pm - 7pm	7am - 9am 4pm - 7pm	--	--	
Laguna Honda (Dewey - Merced)	4pm - 7pm	7am - 9am 4pm - 7pm	--	--	
Lake Merced Blvd. (Sunset - John Muir)	7am - 9am 3pm - 7pm	7am - 9am 3pm - 7pm	--	--	
Larkin St (Market - Grove)	7am - 7pm	--	--	--	
Larkin St (Grove - McAllister)	7am - 7pm	7am - 7pm	--	--	
Larkin St (McAllister - Turk)	7am - 7pm	--	--	--	
Larkin St (Turk - California)	7am - 9am 3pm - 7pm	--	--	--	
Larkin St (California - Broadway)	7am - 9am 3pm - 7pm	7am - 9am 3pm - 7pm	--	--	

STREETS (Limits)	NORTHBOUND	SOUTHBOUND	EASTBOUND	WESTBOUND	ADDITIONAL RESTRICTIONS SEE APPENDIX D MAPS
<b>Laurel St</b> (California - Mayfair)	4pm - 6pm	--	--	--	
<b>Leavenworth St</b> (McAllister - California)	7am - 9am 3pm - 7pm	--	--	--	
<b>Leavenworth St</b> (California - Broadway)	7am - 9am 3pm - 7pm	7am - 9am 3pm - 7pm	--	--	
<b>Lincoln Way</b> (3rd Ave - 20th Ave)	--	--	7am - 7pm Everyday	7am - 7pm Everyday	
<b>Lincoln Way</b> (20th Ave - 38th Ave)	--	--	7am - 9am 4pm - 7pm	7am - 9am 4pm - 7pm	
<b>Lombard St</b> (Broderick - Van Ness)	--	--	7am - 9am 3pm - 7pm	7am - 9am 3pm - 7pm	Caltrans Jurisdiction
<b>Lyell St</b> (Cayuga - Alemany)	--	4pm - 7pm	--	--	
<b>Main St</b> (Market - Folsom)	7am - 9am 3pm - 7pm	--	--	--	
<b>Main St</b> (Folsom - Bryant)	7am - 9am 3pm - 7pm	7am - 9am 3pm - 7pm	--	--	
<b>Marina Blvd.</b> (Broderick - Divisadero)	--	--	4pm - 7pm	4pm - 7pm	
<b>Marina Blvd.</b> (Buchanan - Laguna)	--	--	4pm - 7pm	4pm - 7pm	
<b>Market St</b> (Steuart - Duboce)	--	--	6am - 7pm	6am - 7pm	Maps 2 & 3
<b>Market St</b> (Duboce - Noe)	--	--	7am - 9am 4pm - 7pm	4pm - 7pm	
<b>Market St</b> (Noe - Castro)	--	--	7am - 9am 4pm - 7pm	4pm - 6pm	
<b>Market St</b> (Castro - Corbett)	--	--	7am - 9am	4pm - 6pm	
<b>Mason St</b> (California - Market)	--	7am - 9am 3pm - 7pm	--	--	
<b>Masonic Ave</b> (Waller - Oak)	7am - 9am 4pm - 7pm	4pm - 7pm	--	--	
<b>Masonic Ave</b> (Oak - Presidio)	7am - 7pm Everyday	7am - 7pm Everyday	--	--	
<b>McAllister St</b> (Market - Gough)	--	--	7am - 9am 3pm - 7pm	7am - 9am 3pm - 7pm	
<b>McAllister St</b> (Gough - Octavia)	--	--	4pm - 6pm	4pm - 6pm	
<b>Mission St</b> (Embarcadero - Beale)	--	--	7am - 9am 3pm - 7pm	7am - 9am 3pm - 7pm	
<b>Mission St</b> (Beale - 1st. St)	--	--	7am - 7pm	7am - 7pm	
<b>Mission St</b> (1st St - 11th St)	--	--	7am - 7pm Everyday	7am - 7pm Everyday	Map 2
<b>Mission St</b> (11th St - So. Van Ness)	--	--	7am - 9am 3pm - 7pm	7am - 9am 3pm - 7pm	
<b>Mission St</b> (So. Van Ness - 13th St)	7am - 9am 3pm - 7pm	--	--	--	Caltrans Jurisdiction
<b>Mission St</b> (13th St - Rolph)	7am - 9am 4pm - 7pm	4pm - 7pm	--	--	
<b>Mission St</b> (Rolph – Huron / County Line)	4pm - 7pm	4pm - 7pm	--	--	
<b>Monterey Blvd</b> (Plymouth - Genessee)	--	--	4pm - 7pm	4pm - 7pm	

STREETS (Limits)	NORTHBOUND	SOUTHBOUND	EASTBOUND	WESTBOUND	ADDITIONAL RESTRICTIONS SEE APPENDIX D MAPS
<b>Monterey Blvd</b> (Genessee - Foerster)	--	--	--	4pm - 7pm	
<b>Montgomery St</b> (Market - Washington)	--	7am - 7pm Everyday	--	--	
<b>New Montgomery</b> (Market - Howard)	--	7am - 7pm Everyday	--	--	
<b>North Point St</b> (Columbus - Van Ness)	--	--	7am - 9am	4pm - 6pm	
<b>Oak St</b> (Franklin - Baker)	--	--	7am - 7pm Everyday	--	
<b>Oak St</b> (Baker - Stanyan)	--	--	7am - 10am	--	
<b>Ocean Ave</b> (San Jose - Phelan)	--	--	4pm - 7pm	4pm - 7pm	
<b>Ocean Ave</b> (Phelan - San Fernando)	--	--	7am - 9am 4pm - 7pm	4pm - 7pm	
<b>Ocean Ave</b> (San Fernando – Junipero Serra)	--	--	4pm - 7pm	4pm - 7pm	
<b>Ocean Ave</b> (Junipero Serra - 19th Ave)	--	--	4pm - 6pm	4pm - 6pm	
<b>Octavia Blvd. Main Roadway</b> (Market - Fell)	7am - 10pm Everyday	7am - 10pm Everyday	--	--	
<b>O'Farrell St</b> (Gough - Taylor)	--	--	7am - 9am 3pm - 7pm	--	
<b>O'Farrell St</b> (Taylor - Market)	--	--	7am - 7pm Mon-Sat	--	
<b>O'Shaughnessy Blvd</b> (Portola – 500' South)	4pm - 7pm	4pm - 7pm	--	--	
<b>Otis St</b> (So. Van Ness - McCoppin)	--	--	--	7am - 9am 3pm - 7pm	
<b>Otis St</b> (McCoppin - Duboce)	--	7am - 7pm Everyday	--	--	
<b>Pacific Ave</b> (Front - Powell)	--	--	--	7am - 9am 3pm - 7pm	
<b>Pacific Ave</b> (Powell - Gough)	--	--	7am - 9am 3pm - 7pm	7am - 9am 3pm - 7pm	
<b>Palou St</b> (Newhall - Keith)	--	--	4pm - 7pm	4pm - 7pm	
<b>Park Presidio Blvd.</b> (Fulton - Lake)	7am - 7pm Everyday	7am - 7pm Everyday	--	--	Caltrans Jurisdiction
<b>Park Presidio Bypass</b> (Crossover - Fulton)	7am - 7pm Everyday	7am - 7pm Everyday	--	--	Caltrans Jurisdiction
<b>Parnassus Ave</b> (5th Ave - Hillway)	--	--	4pm - 6pm	4pm - 6pm	
<b>Paul Ave</b> (San Bruno - 3rd St)	--	--	7am - 9am	4pm - 6pm	
<b>Pine St</b> (Market - Sansome)	--	--	--	7am - 9am 3pm - 7pm	
<b>Pine St</b> (Sansome - Kearny)	--	--	--	7am - 7pm	
<b>Pine St</b> (Kearny - Gough)	--	--	--	7am - 9am 3pm - 7pm	
<b>Pine St</b> (Gough - Presidio)	--	--	--	4pm - 7pm	
<b>Polk St</b> (Market - Grove)	--	7am - 7pm Everyday	--	--	

STREETS (Limits)	NORTHBOUND	SOUTHBOUND	EASTBOUND	WESTBOUND	ADDITIONAL RESTRICTIONS SEE APPENDIX D MAPS
<b>Polk St / Dr. Carlton B. Goodlett Pl.</b> (Grove – McAllister)	--	7am - 9am 3pm - 7pm	--	--	
<b>Portola Dr.</b> (Corbett – Clipper / Burnett)	--	--	7am - 9am	4pm - 6pm	
<b>Portola Dr.</b> (Clipper / Burnett - Vicente)	--	--	7am - 9am 4pm - 7pm	4pm - 7pm	
<b>Portola Dr.</b> (Vicente - Junipero Serra)	--	--	7am - 9am	4pm - 6pm	
<b>Post St</b> (Divisadero - Laguna)	--	--	7am - 9am	--	
<b>Post St</b> (Laguna - Gough)	--	--	7am - 9am 4pm - 7pm	4pm - 7pm	
<b>Post St</b> (Gough - Mason)	--	--	7am - 9am 3pm - 7pm	--	
<b>Post St</b> (Mason - Montgomery)	--	--	7am - 7pm	--	
<b>Potrero Ave</b> (Cesar Chavez - Division)	7am - 9am 3pm - 7pm	7am - 9am 3pm - 7pm	--	--	
<b>Powell St</b> (Ellis - Broadway)	7am - 9am 3pm - 7pm	7am - 9am 3pm - 7pm	--	--	
<b>Presidio Ave</b> (Sacramento - Geary)	4pm - 7pm	4pm - 7pm	--	--	
<b>Quintara St</b> (18th Ave - 20th Ave)	--	--	4pm - 7pm	4pm - 7pm	
<b>Richardson Ave</b> (Lyon - Broderick)	7am - 9am 3pm - 7pm	7am - 9am 3pm - 7pm	--	--	Caltrans Jurisdiction
<b>Sacramento St</b> (Drumm - Sansome)	--	--	--	7am - 9am 3pm - 7pm	
<b>Sacramento St</b> (Sansome - Kearny)	--	--	--	7am - 7pm	
<b>Sacramento St</b> (Kearny - Gough)	--	--	--	7am - 9am 3pm - 7pm	
<b>San Bruno Ave</b> (Mansell - Paul)	4pm - 7pm	--	--	--	
<b>San Jose Ave</b> (Guerrero - Mt. Vernon)	7am - 9am 4pm - 7pm	7am - 9am 4pm - 7pm	--	--	
<b>San Jose Ave</b> (Mt. Vernon - Broad)	4pm - 7pm	4pm - 7pm	--	--	
<b>San Jose Ave</b> (Sadowa - County Line)	7am - 9am 4pm - 7pm	4pm - 6pm 4pm - 7pm	--	--	Caltrans Jurisdiction
<b>Sansome St</b> (Sutter - Washington)	7am - 7pm	7am - 7pm	--	--	
<b>Sansome St</b> (Washington- Embarcadero)	7am - 9am 3pm - 7pm	7am - 9am 3pm - 7pm	--	--	
<b>Silver Ave</b> (Elmira – Charter Oak)	--	--	7am - 9am	4pm - 6pm	
<b>Silver Ave</b> (Charter Oak – San Bruno)	--	--	7am - 9am 4pm - 7pm	4pm - 7pm	
<b>Silver Ave</b> (San Bruno - Girard)	--	--	7am - 9am	4pm - 6pm	
<b>Skyline Blvd.</b> (Sloat - County Line)	--	--	--	--	Caltrans Jurisdiction
<b>So. Van Ness</b> (Market - Mission)	7am - 7pm Everyday	7am - 7pm Everyday	--	--	Caltrans Jurisdiction
<b>So. Van Ness</b> (Mission - 13th St)	7am - 9am 3pm - 7pm	7am - 7pm Everyday	--	--	Caltrans Southbound

STREETS (Limits)	NORTHBOUND	SOUTHBOUND	EASTBOUND	WESTBOUND	ADDITIONAL RESTRICTIONS SEE APPENDIX D MAPS
<b>So. Van Ness</b> (13th St - Cesar Chavez)	7am - 9am	4pm - 6pm	--	--	
<b>Spear St</b> (Mission - Harrison)	--	7am - 9am 3pm - 7pm	--	--	
<b>Stanyan St</b> (Frederick - Haight)	7am - 9am 4pm - 7pm	4pm - 7pm	--	--	
<b>Stanyan St</b> (Haight - Fulton)	7am - 7pm Everyday	7am - 7pm Everyday	--	--	
<b>Starr King Way</b> (Gough - Franklin)	--	--	7am - 9am 3pm - 7pm	--	
<b>Sterling St</b> (Harrison - Bryant)	7am - 9am 3pm - 7pm	--	--	--	
<b>Steuart St</b> (Market - Mission)	7am - 9am 3pm - 7pm	7am - 9am 3pm - 7pm	--	--	
<b>Steuart St</b> (Mission - Howard)	--	7am - 9am 3pm - 7pm	--	--	
<b>Stockton St</b> (Columbus - Sutter)	7am - 7pm Everyday	7am - 7pm Everyday	--	--	
<b>Stockton St</b> (Sutter - Market)	--	7am - 7pm Everyday	--	--	
<b>Sunset Blvd</b> (Irving – Lake Merced)	4pm - 7pm	4pm - 7pm	--	--	
<b>Sutter St</b> (Market - Kearny)	--	--	--	7am - 7pm	
<b>Sutter St</b> (Kearny - Mason)	--	--	--	7am - 7pm (Mon-Sat)	
<b>Sutter St</b> (Mason - Gough)	--	--	--	7am - 9am 3pm - 7pm	
<b>Sutter St</b> (Gough - Fillmore)	--	--	4pm - 7pm	4pm - 7pm	
<b>Sutter St</b> (Fillmore - Divisadero)	--	--	--	4pm - 6pm	
<b>Taraval St</b> (15th Ave - 20th Ave)	--	--	7am - 9am 4pm - 7pm	4pm - 7pm	
<b>Taraval St</b> (20th Ave - 46th Ave)	--	--	4pm - 7pm	4pm - 7pm	
<b>Taylor St</b> (Market - California)	7am - 9am 3pm - 7pm	--	--	--	
<b>Taylor St</b> (California - Broadway)	7am - 9am 3pm - 7pm	7am - 9am 3pm - 7pm	--	--	
<b>Townsend St</b> (Embarcadero – 8th St)	--	--	7am - 9am 3pm - 7pm	7am - 9am 3pm - 7pm	Map 3
<b>Turk St</b> (Mason - Gough)	--	--	--	7am - 9am 3pm - 7pm	
<b>Turk St</b> (Gough - Divisadero)	--	--	--	4pm - 7pm	
<b>Turk St</b> (Divisadero - Arguello)	--	--	4pm - 7pm	3pm - 7pm	
<b>Union St</b> (Powell - Stockton)	--	--	4pm - 6pm	4pm - 6pm	
<b>Union St</b> (Octavia - Polk)	--	--	7am - 9am	4pm - 6pm	
<b>Valencia St</b> (Market - McCoppin)	7am - 9am 3pm - 7pm	--	--	--	
<b>Valencia St</b> (McCoppin - Mission)	7am - 9am	4pm - 6pm	--	--	



<b>STREETS (Limits)</b>	<b>NORTHBOUND</b>	<b>SOUTHBOUND</b>	<b>EASTBOUND</b>	<b>WESTBOUND</b>	<b>ADDITIONAL RESTRICTIONS SEE APPENDIX D MAPS</b>
<b>Van Ness Ave</b> (Market - Lombard)	7am - 7pm Everyday	7am - 7pm Everyday	--	--	Caltrans Jurisdiction
<b>Van Ness Ave</b> (Lombard - North Point)	7am - 9am 3pm - 7pm	7am - 9am 3pm - 7pm	--	--	
<b>Washington St</b> (Embarcadero- Drumm)	--	--	7am - 9am 3pm - 7pm	7am - 9am 3pm - 7pm	
<b>Washington St</b> (Drumm- Grant)	--	--	--	7am - 9am 3pm - 7pm	
<b>Washington St</b> (Larkin- Gough)	--	--	--	7am - 9am 3pm - 7pm	
<b>West Portal Ave</b> (Sloat - Ulloa)	--	--	4pm - 7pm	4pm - 7pm	
<b>Winston Dr</b> (Buckingham – 19th Ave)	--	--	4pm - 7pm	4pm - 7pm	
<b>Woodside St</b> (Laguna Honda - Portola)	--	--	7am - 9am 4pm - 7pm	4pm - 7pm	

**TABLE 2**  
**MOSCONE CONVENTION CENTER (SEE MAP 2)**

NO CONSTRUCTION ACITIVITY IS PERMITTED ON THESE STREETS FROM ONE HOUR BEFORE TO ONE HOUR AFTER MAJOR EVENTS AT THE MOSCONE CONVENTION CENTER. CONTRACTOR IS NOT ALLOWED TO LEAVE ANY HOLES, DEBRIS, AND MATERIAL/EQUIPMENT IN THE TRAFFIC LANES, INCLUDING TOW-AWAY LANES, DURING THESE HOURS.

	<b>Street</b>	<b>Limits</b>
1.	Mission Street	2 <sup>nd</sup> Street to 5 <sup>th</sup> Street
2.	Howard Street	3 <sup>rd</sup> Street to 5 <sup>th</sup> Street
3.	Folsom Street	3 <sup>rd</sup> Street to 4 <sup>th</sup> Street
4.	3 <sup>rd</sup> Street	Market Street to Harrison Street
5.	4 <sup>th</sup> Street	Market Street to Harrison Street
6.	5 <sup>th</sup> Street	Mission Street to Howard Street

For event information, see the Moscone Convention Center website:  
<https://www.moscone.com/events>

**TABLE 3  
ORACLE PARK and CHASE CENTER (SEE MAP 3)**

	<b>Street</b>	<b>Limits</b>
1	16 <sup>th</sup> Street	Potrero Avenue to 3 <sup>rd</sup> Street
2	25 <sup>th</sup> Street	Illinois Street to 3 <sup>rd</sup> Street
3	2 <sup>nd</sup> Street	Market Street to The Embarcadero
4	3 <sup>rd</sup> Street	Market Street to Cesar Chavez Street
5	4 <sup>th</sup> Street	Market Street to 3 <sup>rd</sup> Street
6	5 <sup>th</sup> Street	Berry Street to King Street
7	6 <sup>th</sup> Street	Channel Street to Owens Street
8	7 <sup>th</sup> Street	Townsend Street to 16 <sup>th</sup> Street
9	Berry Street	3 <sup>rd</sup> Street to 5 <sup>th</sup> Street
10	Bryant Street	2 <sup>nd</sup> Street to 3 <sup>rd</sup> Street
11	Cesar Chavez Street	Pennsylvania Avenue to Illinois Street
12	Channel Street	3 <sup>rd</sup> Street to 4 <sup>th</sup> Street
13	Harrison Street	The Embarcadero to 3 <sup>rd</sup> Street
14	Illinois Street	Cesar Chavez Street to Mariposa Street
15	King Street	2 <sup>nd</sup> Street to 5 <sup>th</sup> Street
16	Mariposa Street	Pennsylvania Avenue to Illinois Street
17	Mariposa Street	Terry Francois Boulevard to Mississippi Street
18	Market Street	2 <sup>nd</sup> Street to 4 <sup>th</sup> Street
19	Mission Rock Street	3 <sup>rd</sup> Street to Terry Francois Boulevard
21	Owens Street	6 <sup>th</sup> Street to 16 <sup>th</sup> Street
22	Pennsylvania Avenue	I 280 SB onramp to Cesar Chavez Street
23	Terry Francois Blvd	3 <sup>rd</sup> Street to Mariposa Street
24	The Embarcadero	Market Street to King Street
25	Townsend Street	2 <sup>nd</sup> Street to 7 <sup>th</sup> Street

Restrictions apply for all events at Oracle Park. For event information, see the Giants website at:

<https://www.mlb.com/giants>

**APPENDIX D: MAPS**



# MAP 1 Streets of Major Traffic Importance



## Notes:

This map does not show all the restricted streets clearly. Check Table 1 in Appendix C for the detailed list and applicable restrictions.

## MAP 1A Area of Important Streets (Downtown)

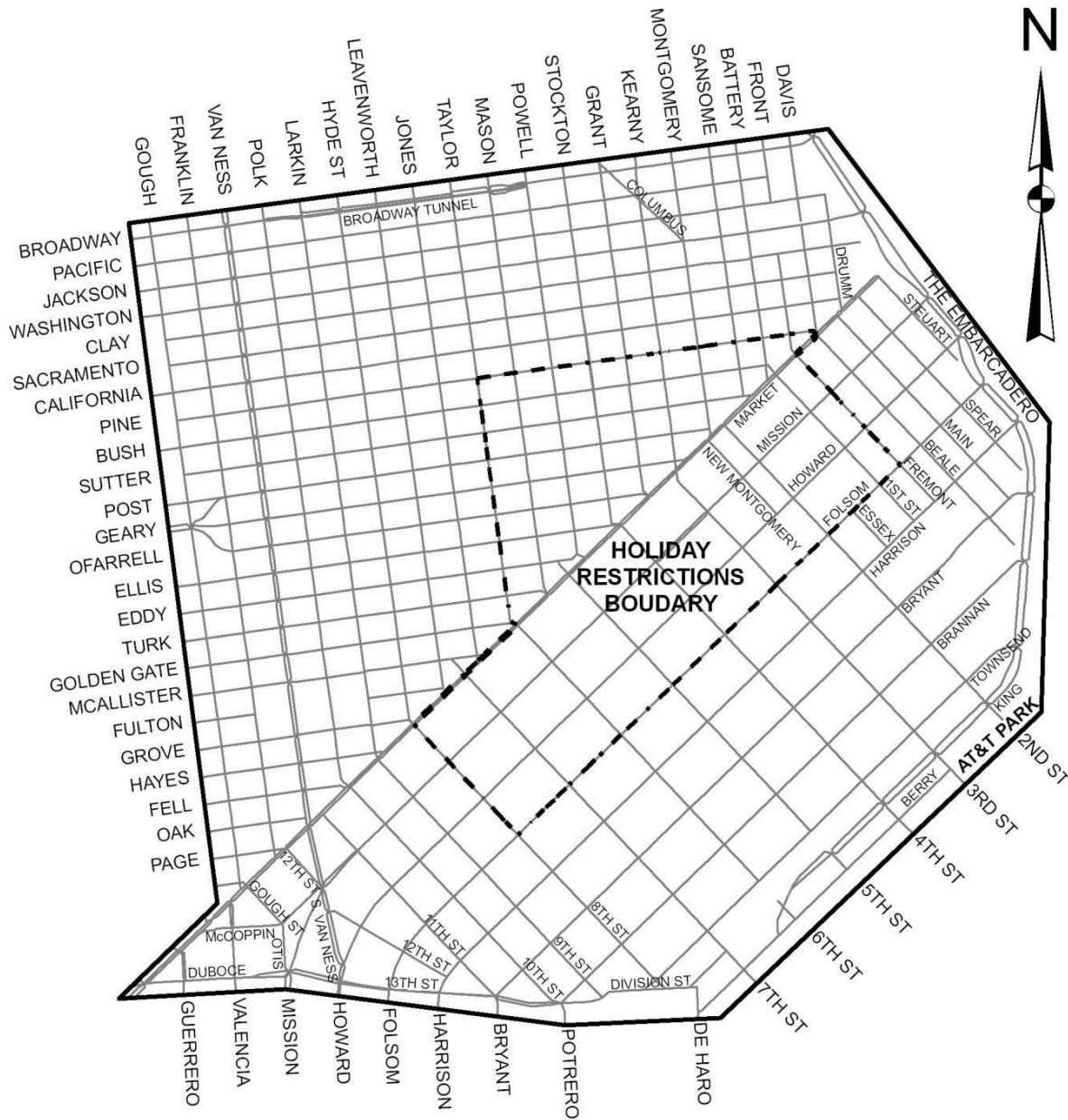

**Notes:**

1. The solid bounded area outlines the downtown area.
2. Within the bounded area construction activity is limited on certain street segments from 7 a.m. to 9 a.m., and 3 p.m. to 7 p.m., Monday to Friday. Refer to Appendix C, Table 1 for specific street segments with these hours restrictions, and other segments that are further restricted.

## MAP 2

### Restrictions for Streets Around Moscone Convention Center During Major Events

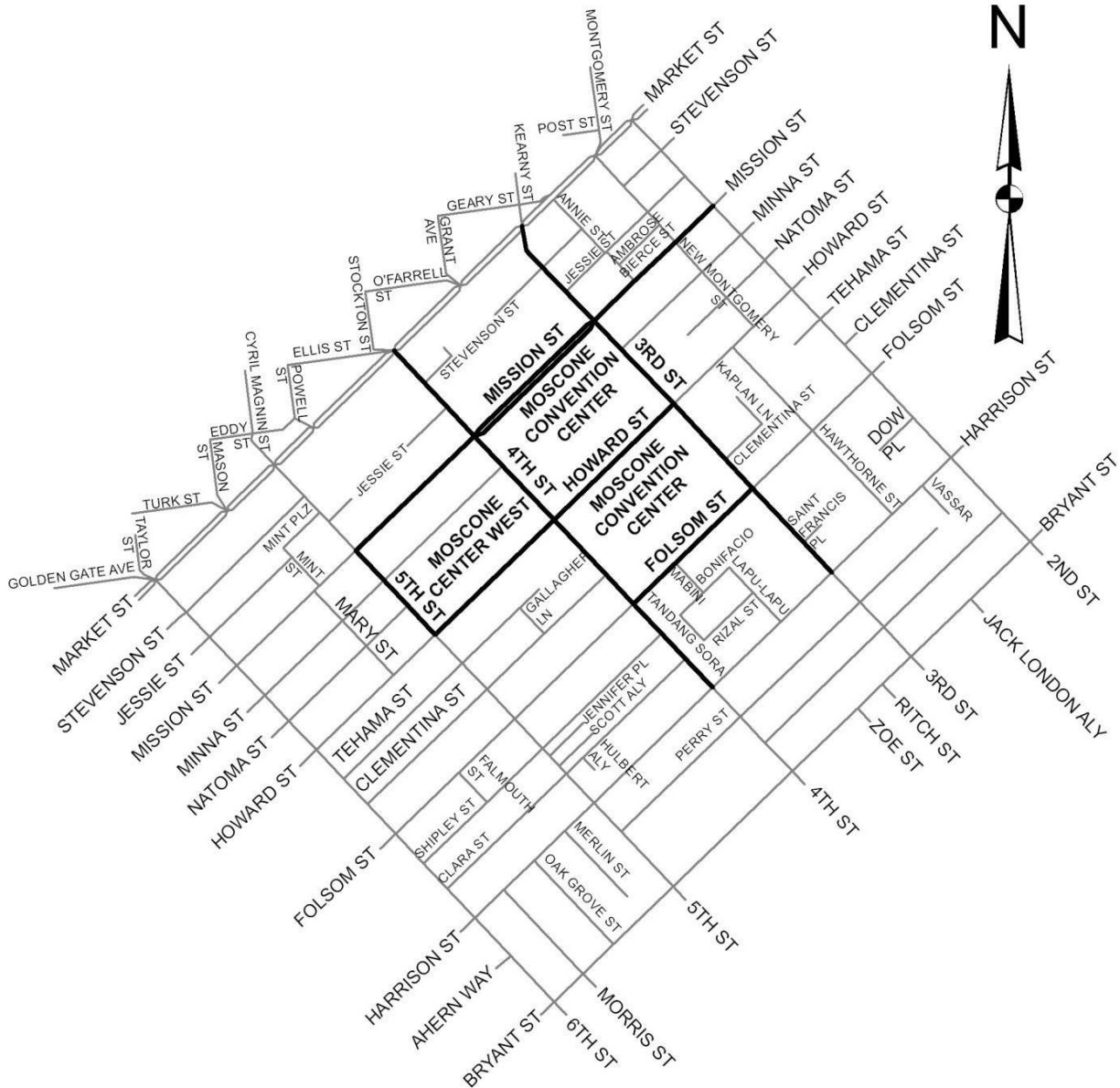

**Notes:**

1. No construction activity is permitted on highlighted streets from one (1) hour before until one (1) hour after major events in the Moscone Center.
2. For information regarding event schedules, see Moscone Center website at <https://www.moscone.com/events> or contact the convention center management at 415.974.4073.

## MAP 3 Ball Park Restrictions

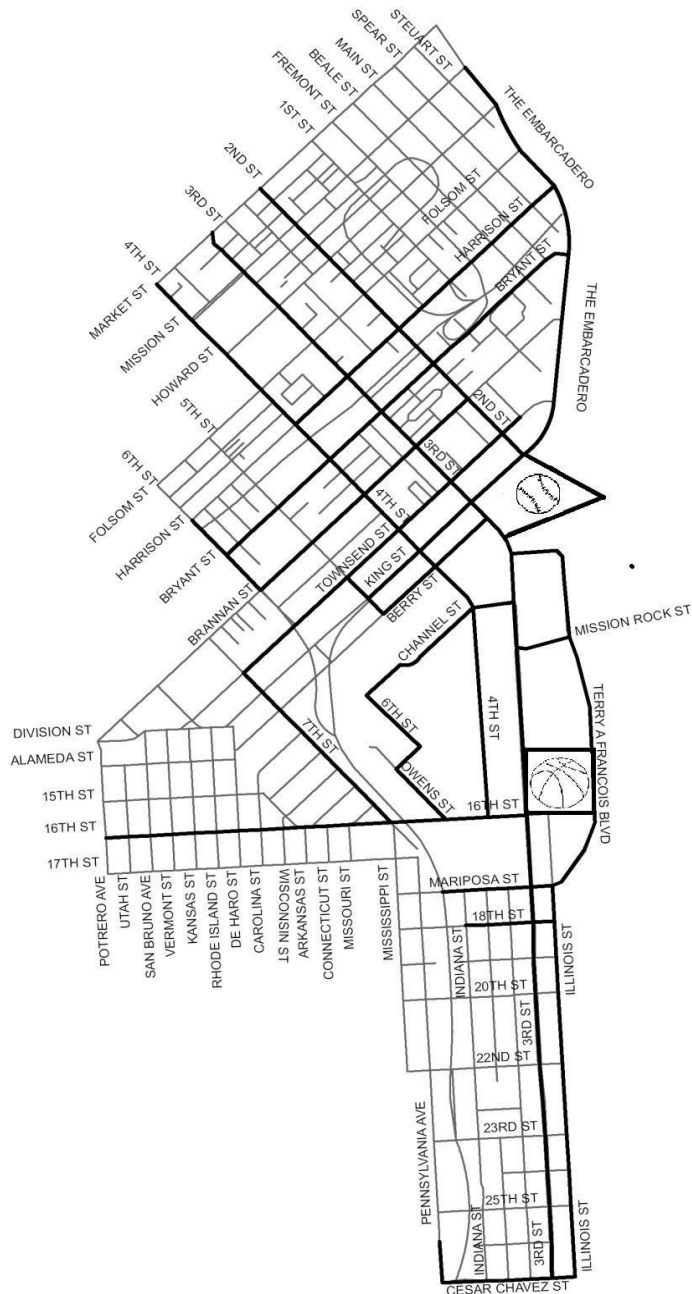

**Notes:**

1. No construction activity is permitted on highlighted streets from two (2) hours before until two (2) hours after events.
2. Call Giants Enterprises at 415.972.1800 for event schedules or check out the Giants website at <https://www.mlb.com/giants>.
3. For Chase Center please visit [www.chasecenter.com/home](http://www.chasecenter.com/home) for event schedules.





**MAP 5**  
**San Francisco Police Department (SFPD) District Construction Coordinators**

**San Francisco Police**  
**District Construction Contacts**

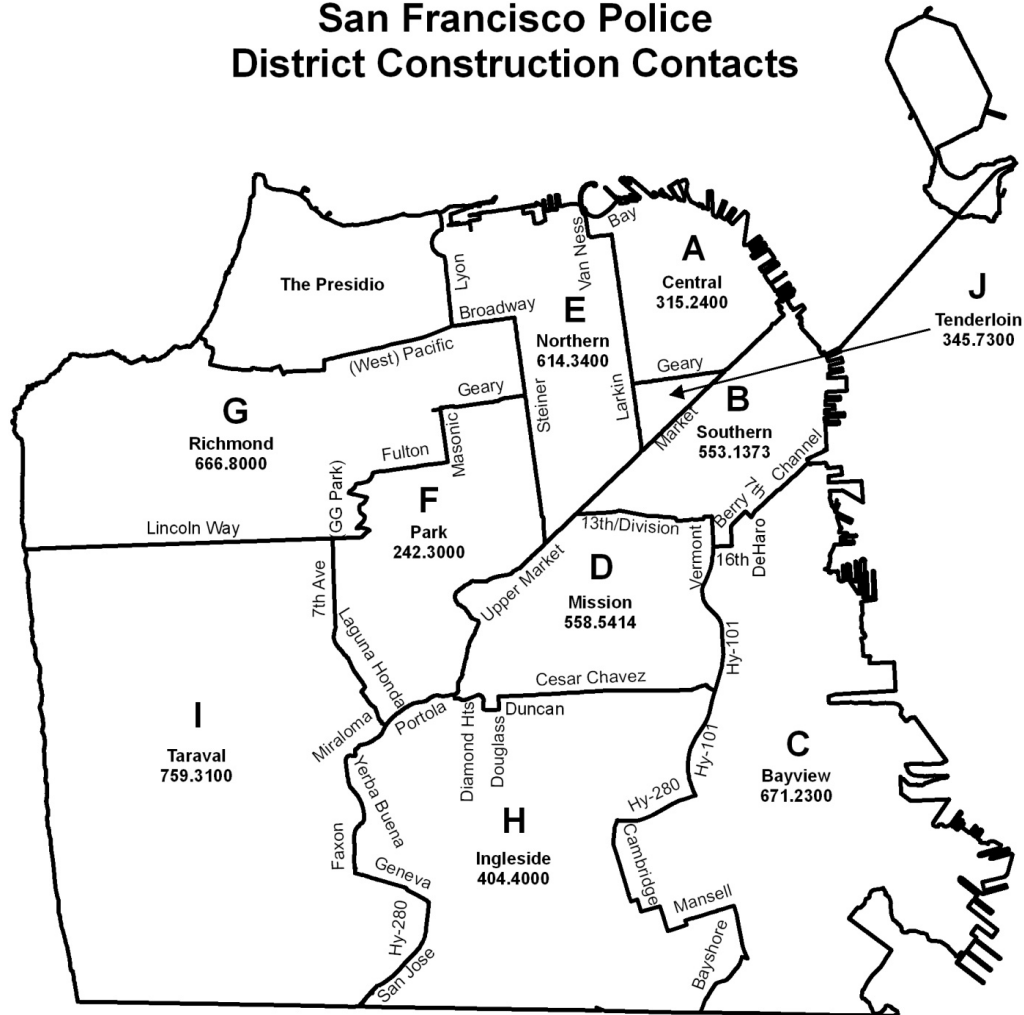

**10B CONSTRUCTION CONTACTS**

	<b>STATION</b>	<b>WORK PHONE</b>	<b>STATION FAX</b>
<b>A</b>	Central	415.315.2400	415.315.2450
<b>B</b>	Southern	415.553.1373	415.553.1073
<b>C</b>	Bayview	415.671.2300	415.671.2345
<b>D</b>	Mission	415.558.5414	415.558.5447
<b>E</b>	Northern	415.614.3400	415.614.3434
<b>F</b>	Park	415.242.3000	415.242.3005
<b>G</b>	Richmond	415.666.8000	415.666.8060
<b>H</b>	Ingleside	415.404.4000	415.404.4008
<b>I</b>	Taraval	415.759.3100	415.753.7220
<b>J</b>	Tenderloin	415.345.7300	415.345.7370

## APPENDIX E: SIGN CHARTS



# California Sign Chart

## Sheet 1 of 12 - Federal Regulatory Signs

California Department of Transportation  
Signs and Work Zones Branch  
January 2010



The chart contains commonly used signs in California, and is not meant to be used as a comprehensive sign chart. California codes are designated by (CA). Otherwise Federal codes are shown. For a complete directory of signs, visit [www.dot.ca.gov/hq/traffops/signtech/signdel/index.htm](http://www.dot.ca.gov/hq/traffops/signtech/signdel/index.htm).

# California Sign Chart

## Sheet 2 of 12 - California Regulatory Signs

This chart contains commonly used signs in California, and is not meant to be used as a comprehensive sign chart.

California codes are designated by (CA). Otherwise Federal codes are shown. For a complete directory of signs, visit [www.dot.ca.gov/hq/traffops/signtech/signdel/index.htm](http://www.dot.ca.gov/hq/traffops/signtech/signdel/index.htm).

California Department of Transportation  
Signs and Work Zones Branch  
January 2010



 R2-4 (CA)	 R3 (CA)	 R6-3 (CA)	 R6-3A (CA)	 R6-4 (CA)	 R6-4A (CA)	 R13A (CA)	 R13B (CA)	 R18A (CA)	 R18A (CA)	
 R18B (CA)	 R20A (CA)	 R20D-1 (CA)	 R20D-2 (CA)	 R20D-3 (CA)	 R20D-4 (CA)	 R20H (CA)	 R20-1 (CA)	 R20-1A (CA)	 R21 (CA)	 R22 (CA)
 R23 (CA)	 R24 (CA)	 R24A (CA)	 R24B (CA)	 R24C (CA)	 R24D (CA)	 R24E (CA)	 R25 (CA)	 R25A (CA)	 R25B (CA)	
 R25C (CA)	 R25D (CA)	 R25E (CA)	 R25F (CA)	 R25H (CA)	 R25J (CA)	 R26 (CA)	 R26A (CA)	 R26A(S) (CA)	 R26F (CA)	
 R26K (CA)	 R26L (CA)	 R26(S) (CA)	 R27 (CA)	 R27A (CA)	 R28 (CA)	 R28(S) (CA)	 R28A (CA)	 R28A(S) (CA)	 R28C (CA)	
 R28D (CA)	 R28D(S) (CA)	 R28E (CA)	 R28F (CA)	 R29 (CA)	 R30 (CA)	 R30A (CA)	 R30B (CA)	 R30C (CA)	 R30D (CA)	
 R30E (CA)	 R30F (CA)	 R31 (CA)	 R31(S) (CA)	 R32 (CA)	 R32B (CA)	 R32C (CA)	 R32D (CA)	 R32E (CA)	 R32F (CA)	
 R33 (CA)	 R33A (CA)	 R33B (CA)	 R33C (CA)	 R36 (CA)	 R37 (CA)	 R38 (CA)	 R38(S) (CA)	 R38A (CA)	 R39 (CA)	
 R39-1 (CA)	 R39-2 (CA)	 R40 (CA)	 R44A (CA)	 R44B (CA)	 R44C (CA)	 R47 (CA)	 R47A (CA)	 R48 (CA)	 R48-1 (CA)	
 R48-2 (CA)	 R51 (CA)	 R50 (CA)	 R52 (CA)	 R52A (CA)	 R53A (CA)	 R53B (CA)	 R53D (CA)	 R53E (CA)	 R55 (CA)	

# California Sign Chart

## Sheet 3 of 12 - California Regulatory Signs

This chart contains commonly used signs in California, and is not meant to be used as a comprehensive sign chart. California codes are designated by (CA). Otherwise Federal codes are shown. For a complete directory of signs, visit [www.dot.ca.gov/hq/traffops/signtech/signdel/index.htm](http://www.dot.ca.gov/hq/traffops/signtech/signdel/index.htm).

California Department of Transportation  
Signs and Work Zones Branch  
January 2010



R87 (CA)	R88 (CA)	R60B (CA)	R81-1 (CA)	R81-3 (CA)	R81-5 (CA)	R81-7 (CA)	R81-9 (CA)	R81-11 (CA)	R81-13 (CA)
R81-15 (CA)	R81-17 (CA)	R81-19 (CA)	R81-22 (CA)	R81-24 (CA)	R81-26 (CA)	R81-28 (CA)	R81-30 (CA)	R81-32 (CA)	R81-34 (CA)
R81-36 (CA)	R82C (CA)	R62E (CA)	R70 (CA)	R73-1 (CA)	R73-2 (CA)	R73-3 (CA)	R73-4 (CA)	R73-5 (CA)	R73-6 (CA)
R73-8 (CA)	R73-9 (CA)	R74 (CA)	R75 (CA)	R76 (CA)	R76-1 (CA)	R77 (CA)	R78 (CA)	R79 (CA)	R80-1 (CA)
R81 (CA)	R81A (CA)	R81B (CA)	R82A (CA)	R82B (CA)	R82-1 (CA)	R84-1 (CA)	R84-2 (CA)	R86 (CA)	R86-2 (CA)
R86-3 (CA)	R87-1 (CA)	R87-2 (CA)	R88 (CA)	R88-1 (CA)	R88-2 (CA)	R89-1 (CA)	R89-2 (CA)	R89-3 (CA)	R89-4 (CA)
R91-3 (CA)	R91B (CA)	R92 (CA)	R93A (CA)	R93-2 (CA)	R94 (CA)	R99 (CA)	R99B (CA)	R99C (CA)	R100A (CA)
R100B (CA)	R101 (CA)	R102 (CA)	R102A (CA)	R103 (CA)	R103A (CA)	R104 (CA)	R104A (CA)	R105 (CA)	R105A (CA)
S3-1 (CA)	S8 (CA)	S20 (CA)	S21 (CA)	S22 (CA)	S22-1 (CA)	S23 (CA)	S24 (CA)	S30-1 (CA)	S30-2 (CA)
S30-3 (CA)	S30-4 (CA)	S30-5 (CA)	S33 (CA)	S34 (CA)	SR2 (CA)	SR5-1 (CA)	SR6-1 (CA)	SR7-1 (CA)	SR8-1 (CA)

# California Sign Chart

## Sheet 5 of 12 - Federal Warning Signs

California Department of Transportation  
Signs and Work Zones Branch  
January 2010



This chart contains commonly used signs in California, and is not meant to be used as a comprehensive sign chart. California codes are designated by (CA). Otherwise Federal codes are shown. For a complete directory of signs, visit [www.dot.ca.gov/hq/traffops/signtech/signdel/index.htm](http://www.dot.ca.gov/hq/traffops/signtech/signdel/index.htm).

W1-1	W1-1a	W1-2	W1-2a	W1-3	W1-4	W1-5	W1-6	W1-7	W1-8
W1-10	W1-13	W1-15	W2-1	W2-2	W2-4	W2-5	W3-1	W3-2	W3-3
W3-3a	W4-1	W4-2	W4-3	W4-4p	W4-7	W5-1	W5-2	W5-3	W6-1
W6-2	W6-3	W7-1b	W7-2b	W7-3	W7-3a	W7-3b	W7-4	W7-4b	W8-1
W8-2	W8-3	W8-4	W8-5	W8-8	W8-1	W10-1	W10-1a	W10-2	W10-12
W11-1	W11-2	W11-3	W11-4	W11-5	W11-7	W12-1	W12-2	W12-2p	W13-1
W13-2	W13-3	W14-1	W14-2	W14-3	W15-1	W16-1	W16-2	W16-2a	W16-7p
W16-8p	S1-1	S3-1	S4-3	S4-5	S4-5a				

# California Sign Chart

## Sheet 6 of 12 - California Warning Signs

California Department of Transportation  
Signs and Work Zones Branch  
January 2010



This chart contains commonly used signs in California, and is not meant to be used as a comprehensive sign chart. California codes are designated by (CA). Otherwise Federal codes are shown. For a complete directory of signs, visit [www.dot.ca.gov/hq/traffops/signtech/signdel/index.htm](http://www.dot.ca.gov/hq/traffops/signtech/signdel/index.htm).

W4-1 (CA)	W4-10 (CA)	W4-14 (CA)	W4-18 (CA)	W4-22 (CA)	W11-1 (CA)	W20 (CA)	W20A (CA)	W20A (CA)	W30B (CA)	W30C (CA)
W31 (CA)	W31A (CA)	W34A (CA)	W34C (CA)	W38 (CA)	W43 (CA)	W44A (CA)	W46A (CA)	W48 (CA)	W49 (CA)	
W50 (CA)	W50-1 (CA)	W51 (CA)	W55 (CA)	W55B (CA)	W59-1 (CA)	W61A (CA)	W61B (CA)	W61C (CA)	W61E (CA)	W61D (CA)
W61F (CA)	W61G (CA)	W61H (CA)	W66B (CA)	W69 (CA)	W70 (CA)	W72B (CA)	W73 (CA)	W73A (CA)	W74-1 (CA)	W75-1 (CA)
W82 (CA)	W82-1 (CA)	W83 (CA)	SW4-1 (CA)	SW17-1 (CA)	SW22-1 (CA)	SW22-1A (CA)	SW26 (CA)	SW28 (CA)	SW32 (CA)	
SW35 (CA)	SW36 (CA)	SW37 (CA)	SW38 (CA)	SW41 (CA)	SW44 (CA)	SW45 (CA)	SW46 (CA)	SW47 (CA)	SW48 (CA)	
SW48-1 (CA)	SW49 (CA)	SW50 (CA)	SW52 (CA)	SW54 (CA)	SW54-1 (CA)	SW54A (CA)	SW54B (CA)	SW54C (CA)	SW58 (CA)	
SW59 (CA)	SW60 (CA)	Type R (CA)	Type P (CA)	Type N (CA)	Type L (CA)	Type K (CA)	Type Q (CA)			



# California Sign Chart

## Sheet 11 of 12 - Federal Temporary Traffic Control Signs

California Department of Transportation  
Signs and Work Zones Branch  
January 2010



This chart contains commonly used signs in California, and is not meant to be used as a comprehensive sign chart. California codes are designated by (CA). Otherwise Federal codes are shown. For a complete directory of signs, visit [www.dot.ca.gov/hq/traffops/signtech/signel/index.htm](http://www.dot.ca.gov/hq/traffops/signtech/signel/index.htm).

E5-2	E5-2a	G20-1	G20-2	G20-4	G20-5aP	M4-8	M4-8a	M4-9a	M4-10	
R2-12	R3-1	R4-1	R8-11a	R11-2	R11-2 (Alternates)	R11-3a	R11-4	W1-4	W1-6	
W1-8	W3-3	W3-4	W3-5	W3-5a	W4-1	W4-2	W8-6	W8-7	W8-9	
W8-3	W8-12	W12-1	W12-2	W14-3	W16-2	W20-1	W20-1 (Alternate)	W20-2	W20-3	
W20-3 (Alternate)	W20-4	W20-5	W20-5a	W21-1	W21-1a	W21-2	W21-3	W21-5	W21-5b	
W21-6	W21-7	W22-1	W22-2	W22-3	W23-1	Paddle	Paddle			

# California Sign Chart

## Sheet 12 of 12 - California Temporary Traffic Control Signs

This chart contains commonly used signs in California, and is not meant to be used as a comprehensive sign chart.

California codes are designated by (CA). Otherwise Federal codes are shown. For a complete directory of signs, visit [www.dot.ca.gov/hq/traffops/signtech/signdel/index.htm](http://www.dot.ca.gov/hq/traffops/signtech/signdel/index.htm).

California Department of Transportation  
Signs and Work Zones Branch  
January 2010



C8A (CA)	C12 (CA)	Front C17 (CA)	Back C17 (CA)	C20 (CA)	C20A (CA)	C20B (CA)	C23B (CA)	C24 (CA)	C27 (CA)	C29 (CA)
C30 (CA)	C30A (CA)	C31A (CA)	C37 (CA)	C37 (CA)	C38 (CA)	C40 (CA)	C40A (CA)	C43 (CA)	C44 (CA)	
SC3 (CA)	SC5 (CA)	SC6-3 (CA)	SC6-4 (CA)	SC6A (CA)	SC6B (CA)	SC7 (CA)	SC8 (CA)	SC9 (CA)	SC10 (CA)	
SC11 (CA)	SC13 (CA)	SC15 (CA)	SC18 (CA)	SC19 (CA)	SC20 (CA)	SC21 (CA)	Type R (CA)	Type P (CA)	Type N (CA)	
Type II Barricade	Cone, Tubular Marker, Channelizer	Plastic Drum								

## ADDITIONAL PEDESTRIAN SIGNS (CAMUTCD 2006)



R9-9



R9-10

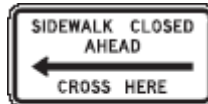

R9-11



R9-11a

## TEMPORARY "TOW-AWAY NO STOPPING" SIGNS

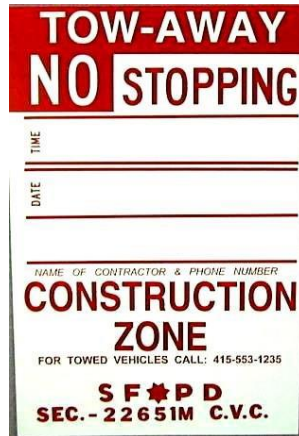

Regular Tow-Away Sign

(Must be posted continuously for and registered 72 hours in advance of effective date and time.)

## BICYCLE SIGNS



(CAMUTCD 2010)

**Muni TEMPORARY BUS STOP SIGNS**

All signs are 12" x 24", black on orange. Unauthorized use of these signs is a violation of this manual and is subject to fines of up to \$5,000.

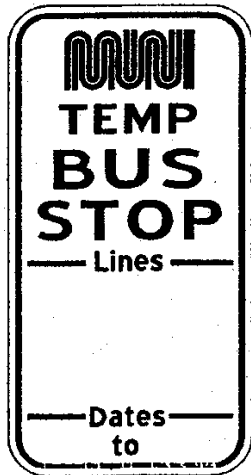
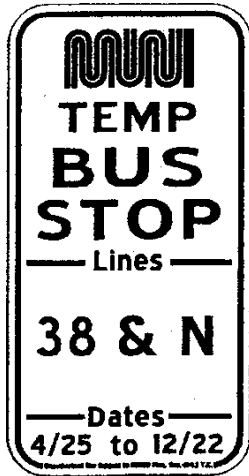

3" Logo  
 1.5" UC  
 2" UC  
 1" UC/.75" LC  
 1" UC/.75" LC  
 0.5" UC/.35" LC



3" Logo  
 2" UC  
 1.5" UC  
 1" UC/.75" LC  
 0.5" UC/.35" LC

## CHANNELIZING DEVICES

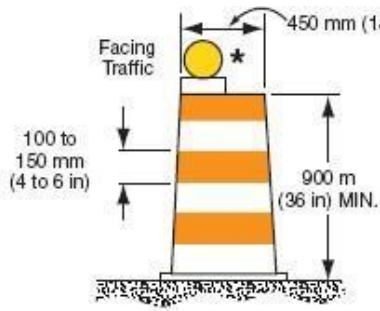

**DRUM**

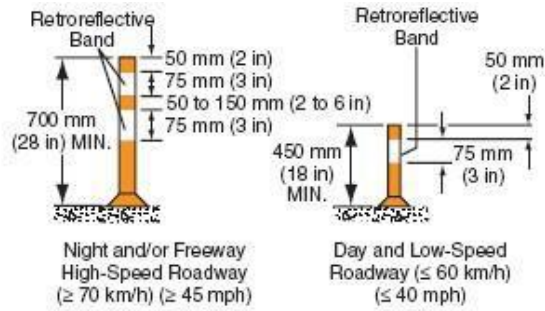

**TUBULAR MARKERS**

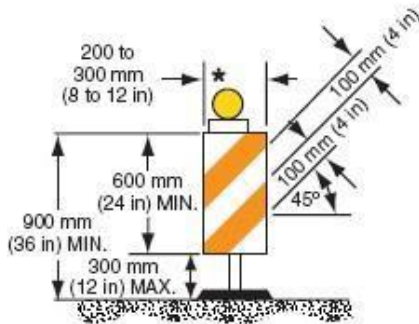

**VERTICAL PANEL**

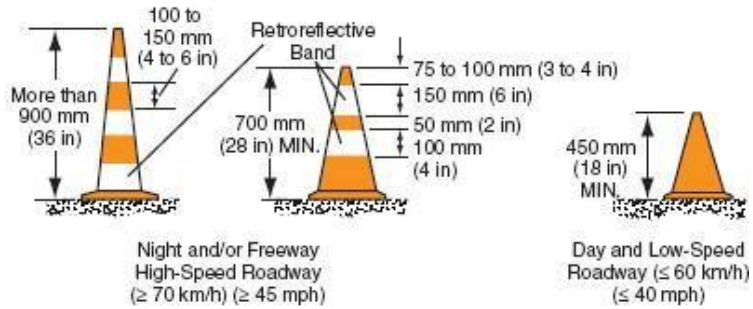

**CONES**

\* Warning lights (optional)

Note: If drums, cones, or tubular markers are used to channelize pedestrians, they shall be located such that there are no gaps between the bases of the devices, in order to create a continuous bottom, and the height of each individual drum, cone, or tubular marker shall be no less than 900 mm (36 in) to be detectable to users of long canes.

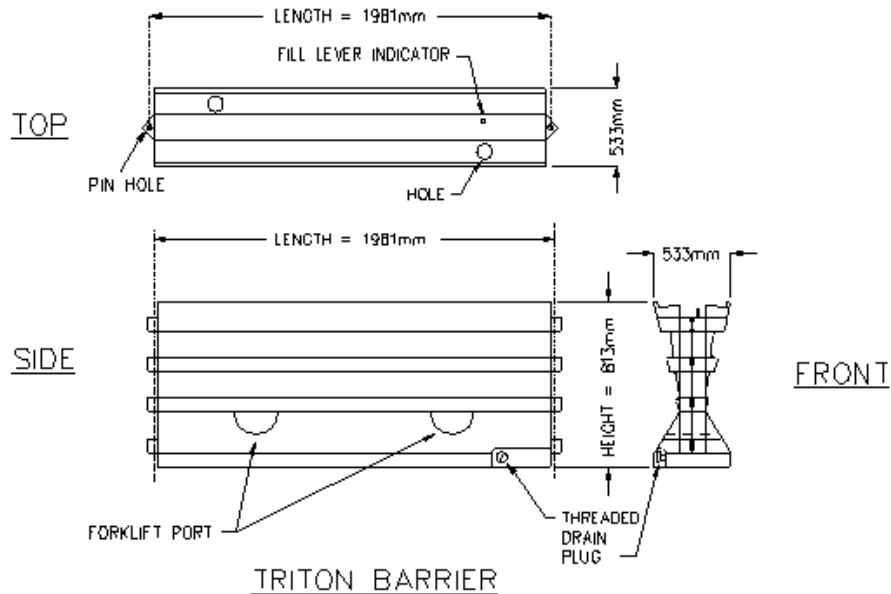

**TRITON BARRIER**

## CHANNELIZING DEVICES (cont'd)

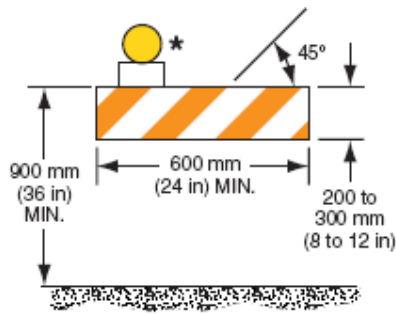

**TYPE I BARRICADE \*\***

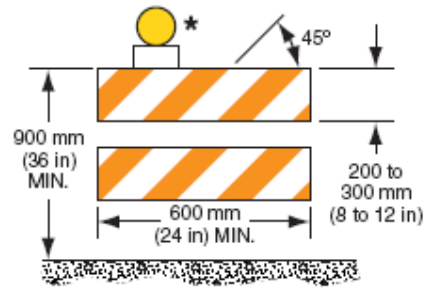

**TYPE II BARRICADE \*\***

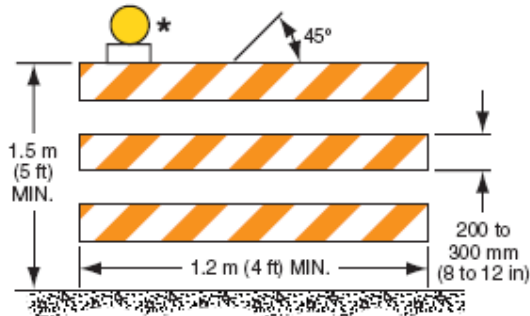

**TYPE III BARRICADE \*\***

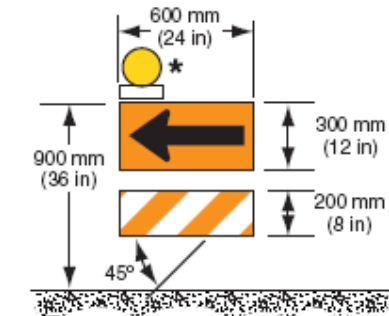

**DIRECTION INDICATOR BARRICADE \*\***

- \* Warning lights (optional)
- \*\* Rail stripe widths shall be 150 mm (6 in), except that 100 mm (4 in) wide stripes may be used if rail lengths are less than 900 mm (36 in). The sides of barricades facing traffic shall have retroreflective rail faces.





















Note: If barricades are used to channelize pedestrians, there shall be continuous detectable bottom and top rails with no gaps between individual barricades to be detectable to users of long canes. The bottom of the bottom rail shall be no higher than 150 mm (6 in) above the ground surface. The top of the top rail shall be no lower than 900 mm (36 in) above the ground surface.

## APPENDIX F: TYPICAL LANE CLOSURE PLANS



The following Lane Closure Plans and accompanying Tables are examples taken or adapted from the California MUTCD issued by Caltrans. They are included here for demonstrative purposes only. Prior to the implementation of any closure the Contractor shall consult these references for details and additional information regarding use, placement and policy. In addition, all closures are subject to the review and approval of the SFMTA and may require a Special Traffic Permit.

**Table 6H-2. Meaning of Symbols on Typical Application Diagrams**

Arrow panel	
Arrow panel support or trailer (shown facing down)	
Changeable message sign or support trailer	
Channelizing device	
Crash Cushion	
Direction of temporary traffic detour	
Direction of traffic	
Flagger	
High level warning device (Flag tree)	
Luminaire	
Pavement markings that should be removed for a long term project	
Sign (shown facing left)	
Surveyor	
Temporary barrier	
Temporary barrier with warning lights	
Traffic or Pedestrian signal	
Truck mounted attenuator	
Type III Barricade	
Warning lights	
Work space	
Work vehicle	



**Table 6H-3: Meaning of Letter Codes on Typical Application Diagrams  
Distance Between Signs\*\***

<b>Road Type</b>	<b>A</b>	<b>B</b>	<b>C</b>
Urban (low speed)*	30 m (100 ft)	30 m (100 ft)	30 m (100 ft)
Urban (high speed)*	100 m (350 ft)	100 m (350 ft)	100 m (350 ft)
Rural	150 m (500 ft)	150 m (500 ft)	150 m (500 ft)
Expressway / Freeway	300 m (1,000 ft)	450 m (1,500 ft)	800 m (2,640 ft)

\* Speed category to be determined by highway agency.

\*\* Distances are shown in meters (feet). The column headings A, B, and C correspond to the dimensions shown in the Figures. The A dimension is the distance from the transition or point of restriction to the first sign. The B dimension is the distance between the first and second signs. The C dimension is the distance between the second and third signs. (The third sign is the first one in a three-sign series encountered by a driver approaching a TTC zone.) 1 ft = 0.3048 m.

**Table 6H-4: Formulas for Determining Taper Lengths**

<b>Speed Limit (S)</b>	<b>Taper Length (L)</b>	<b>Speed Limit (S)</b>	<b>Taper Length (L)</b>
60 km/h or less	$L = \frac{WS^2}{155}$	40 mph or less	$L = \frac{WS^2}{60}$
70 km/h or more	$L = \frac{WS}{1.6}$	45 mph or more	$L = WS$

Where:

L = taper length in meters (feet)

W = width of offset in meters (feet)

S = posted speed limit, or off-peak 85th-percentile speed prior to work starting, or the anticipated operating speed in km/h (mph).

1 mph = 1.609344 km/h.



Figure 6H-6. Shoulder Work with Minor Encroachment (TA-6)

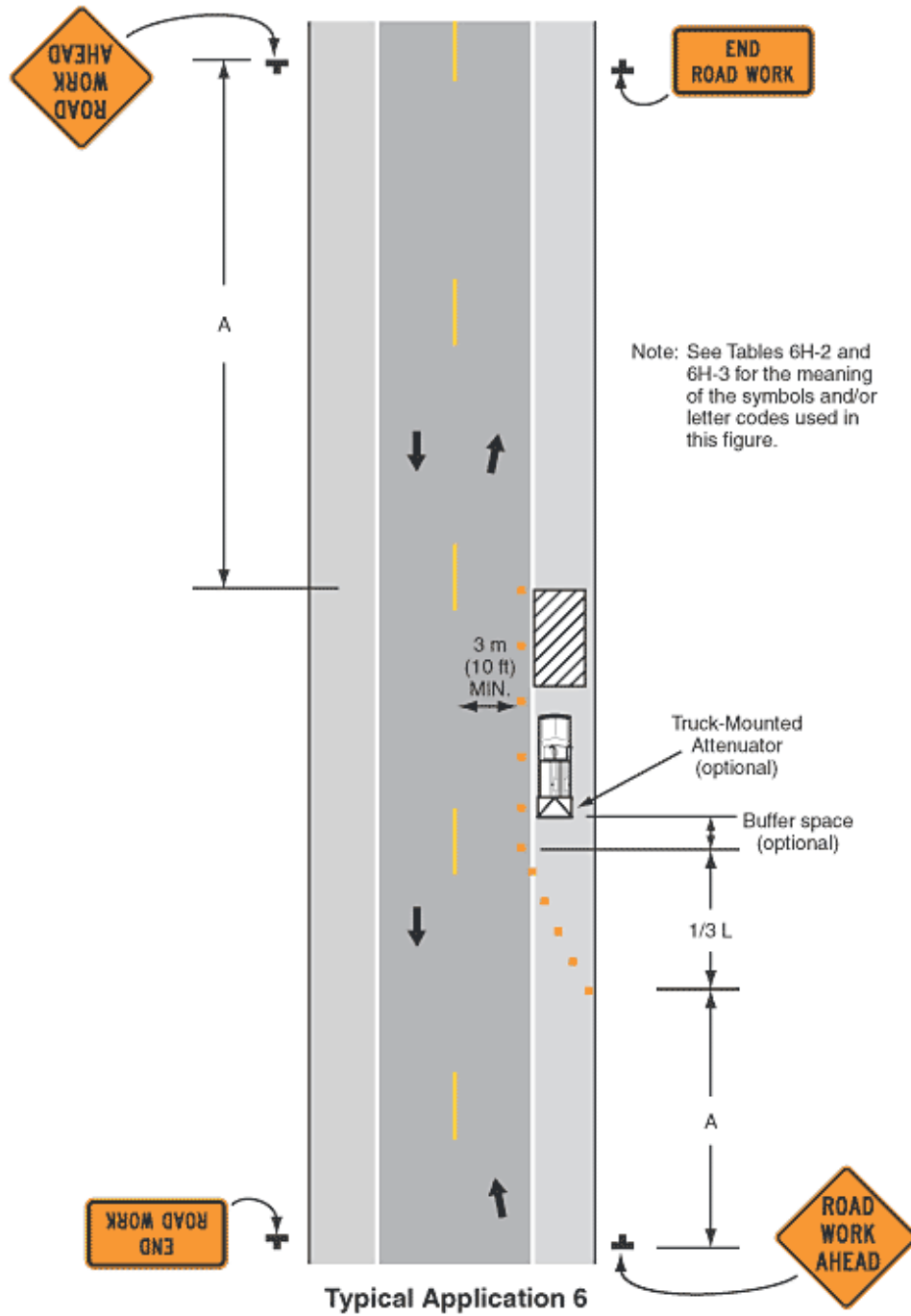

Figure 6H-10 (CA). Lane Closure on Two-Lane Road Using Flaggers (TA-10)

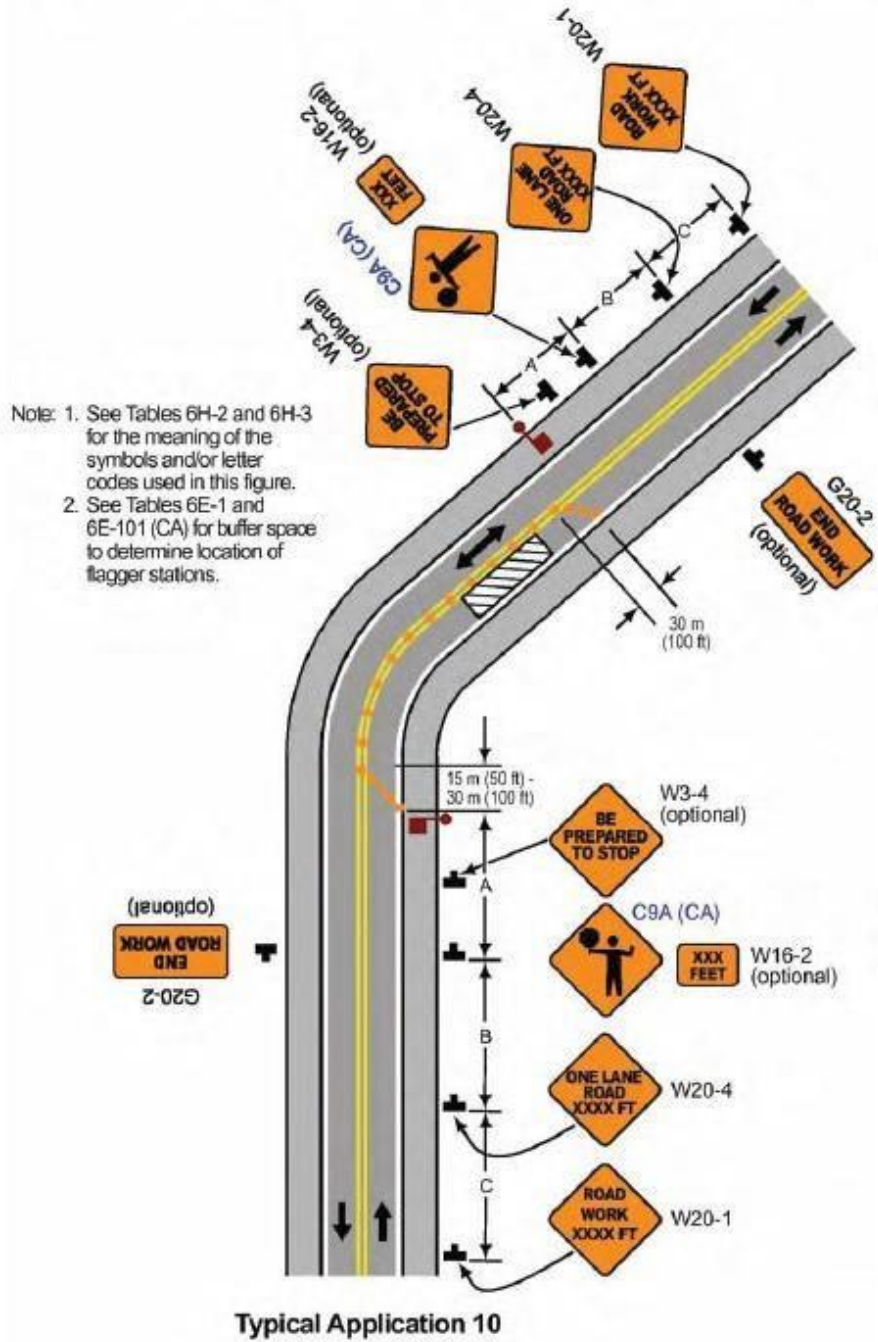



Figure 6H-15. Work in Center of Road with Low Traffic Volumes (TA-15)

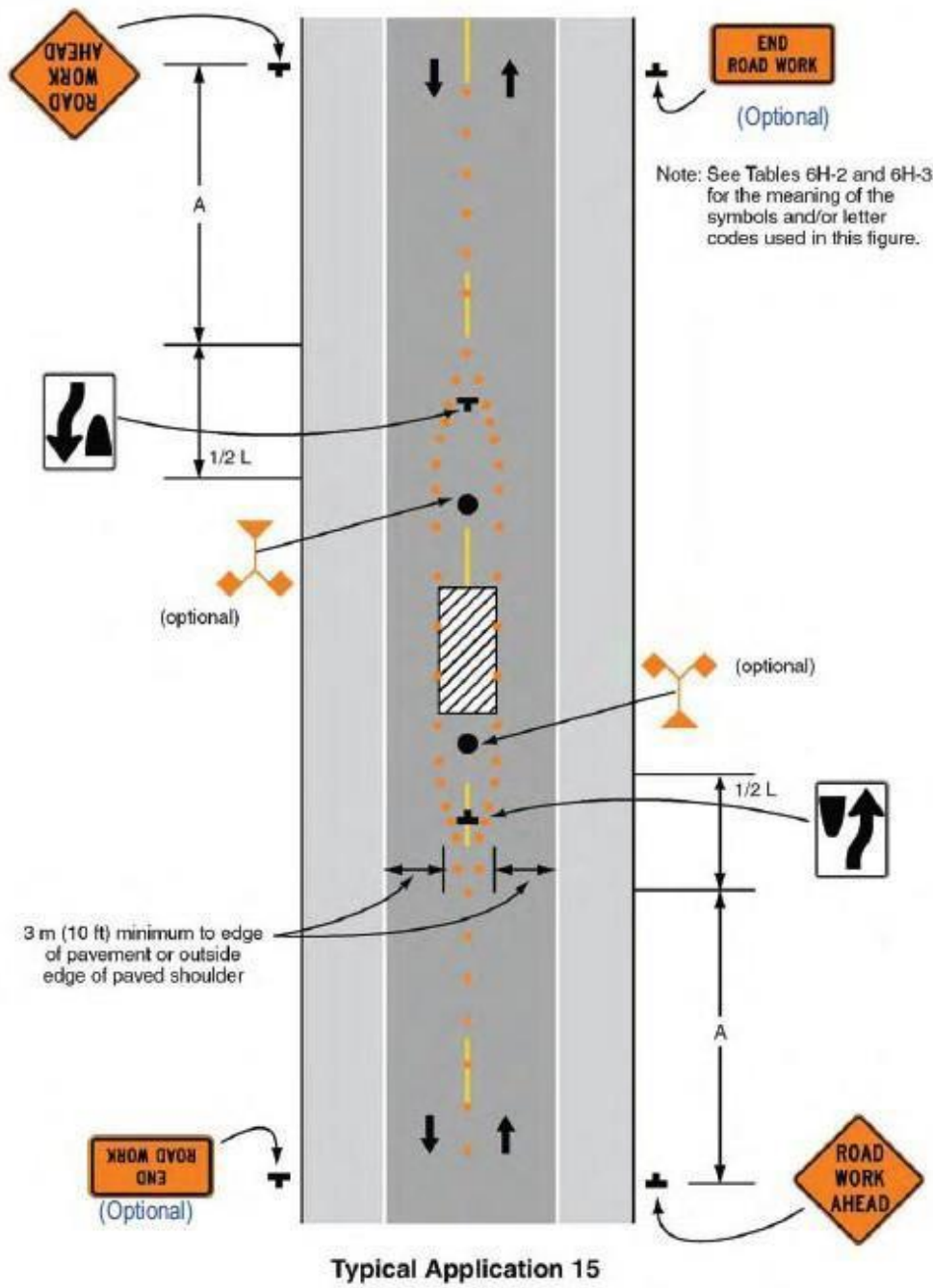

Figure 6H-21. Lane Closure on Near Side of Intersection (TA-21)

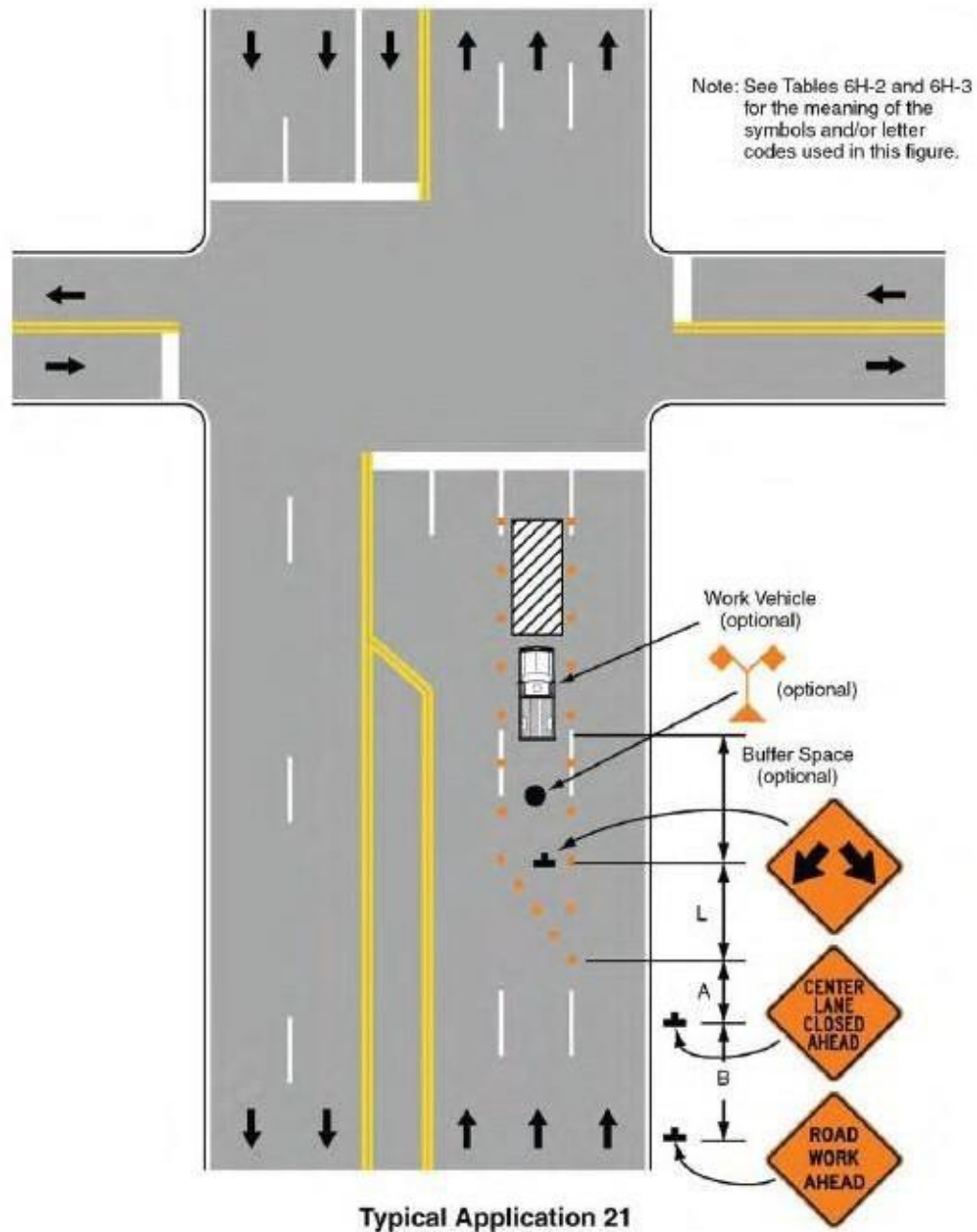

Figure 6H-22. Right Lane Closure on Far Side of Intersection (TA-22)

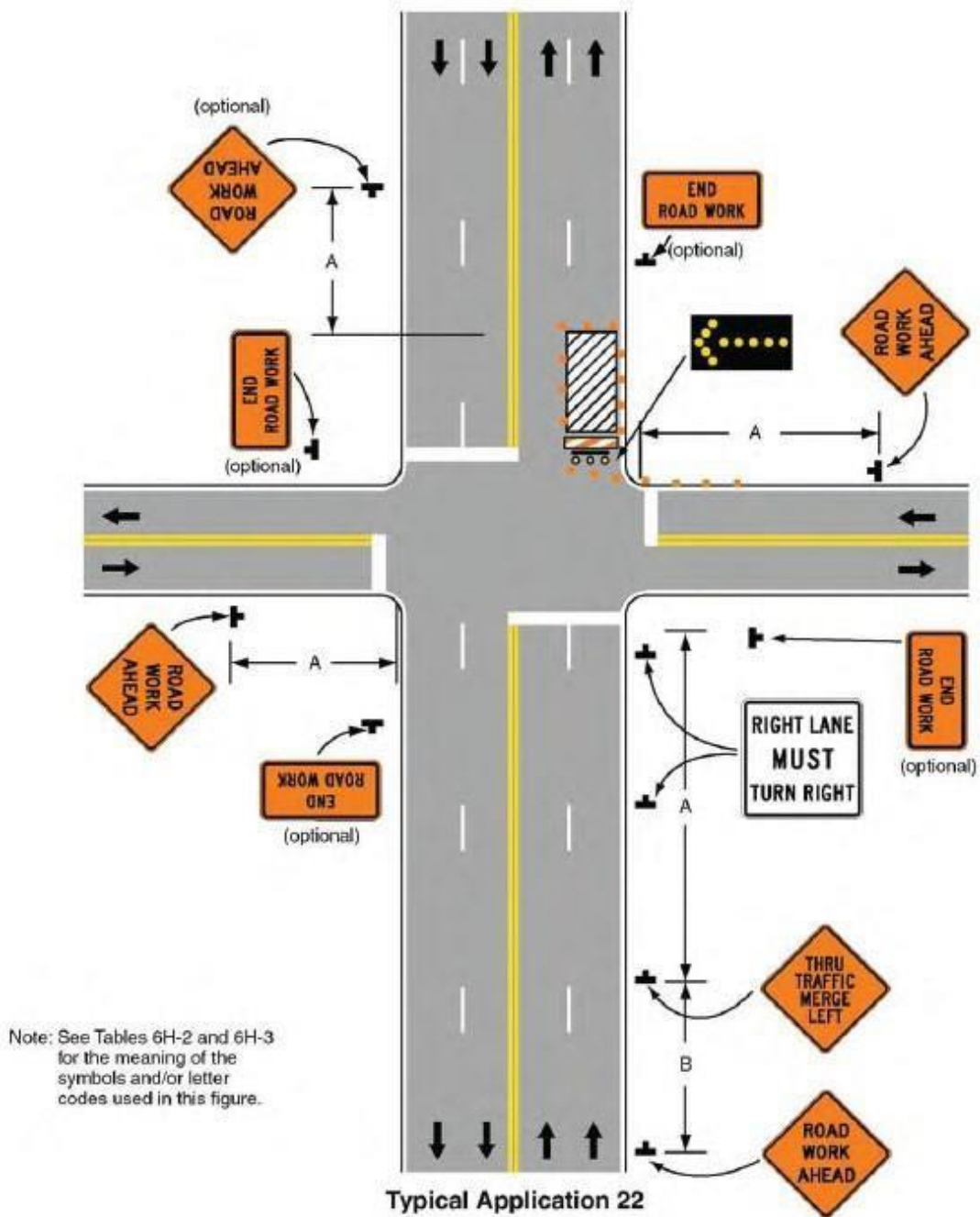



Figure 6H-23. Left Lane Closure on Far Side of Intersection (TA-23)

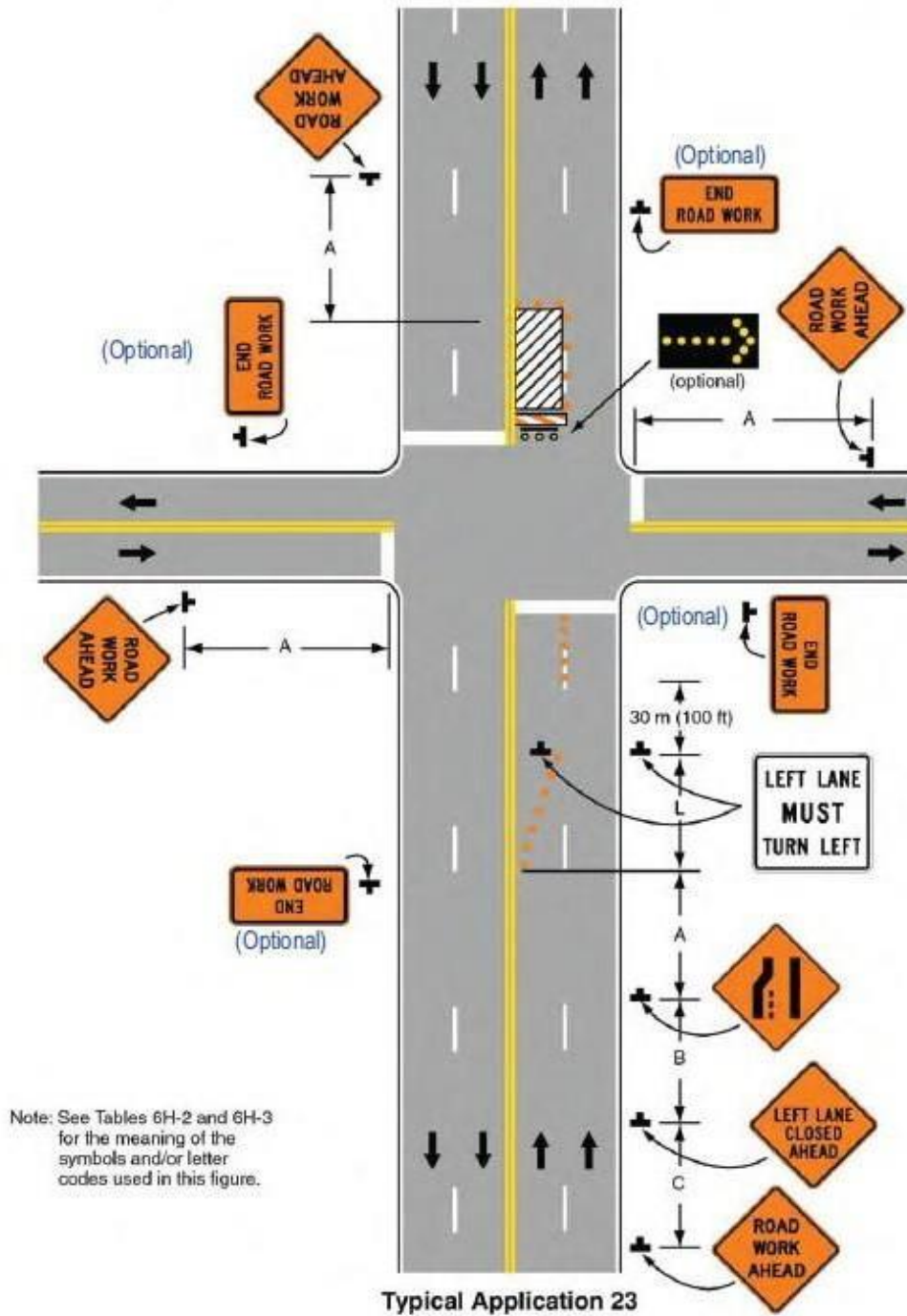

Figure 6H-24. Half Road Closure on Far Side of Intersection (TA-24)

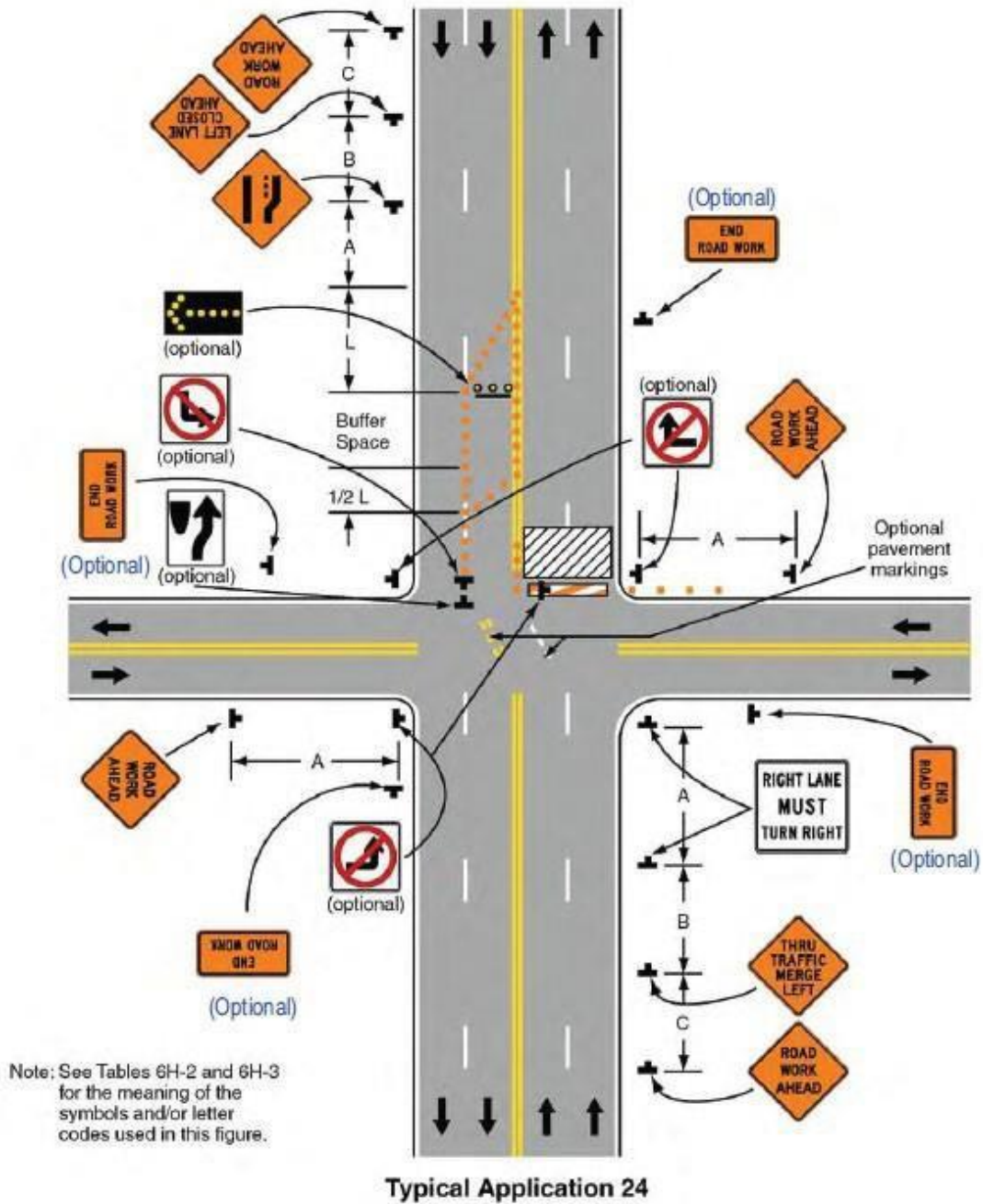

Figure 6H-25. Multiple Lane Closures at Intersection (TA-25)

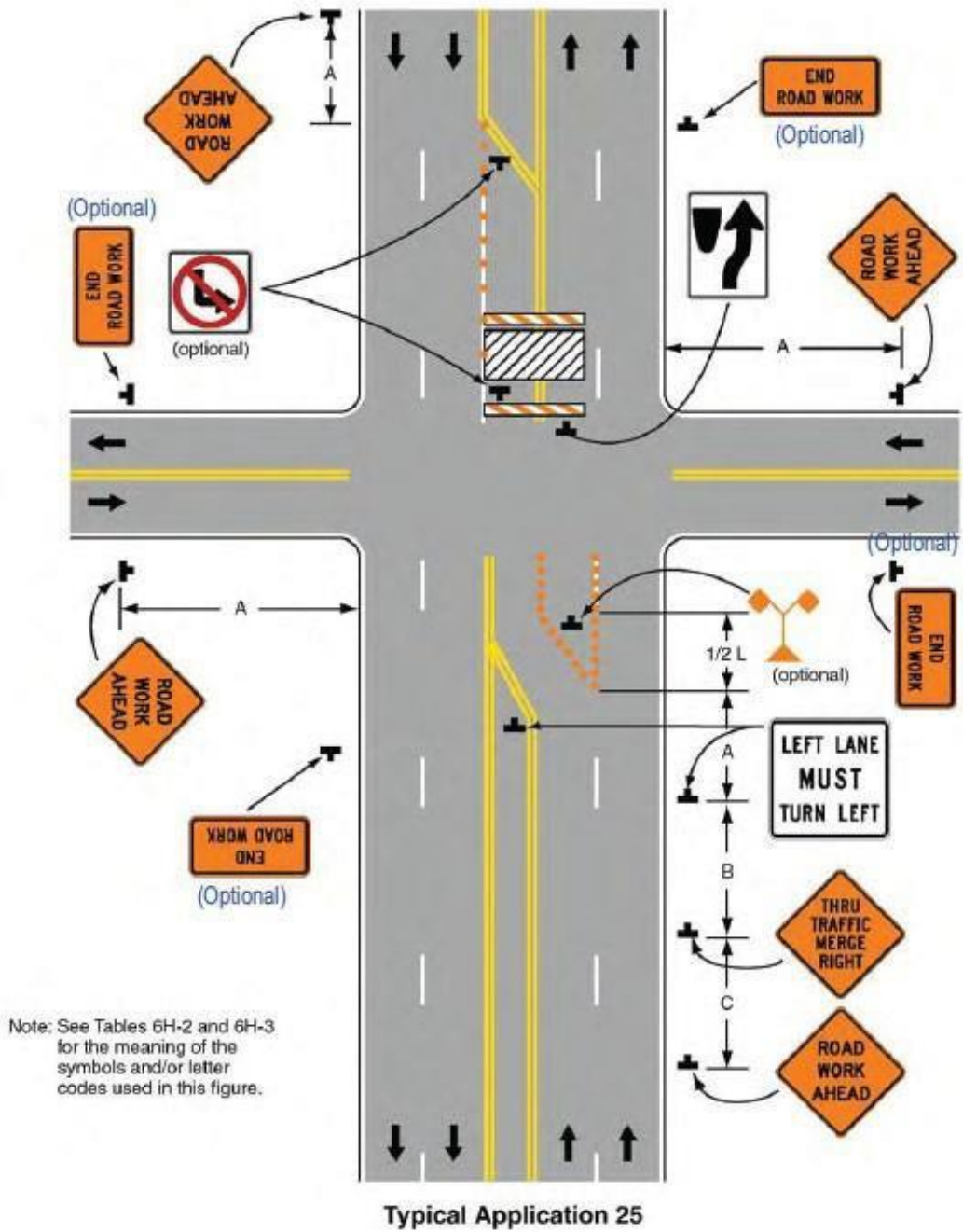

Figure 6H-26. Closure in Center of Intersection (TA-26)

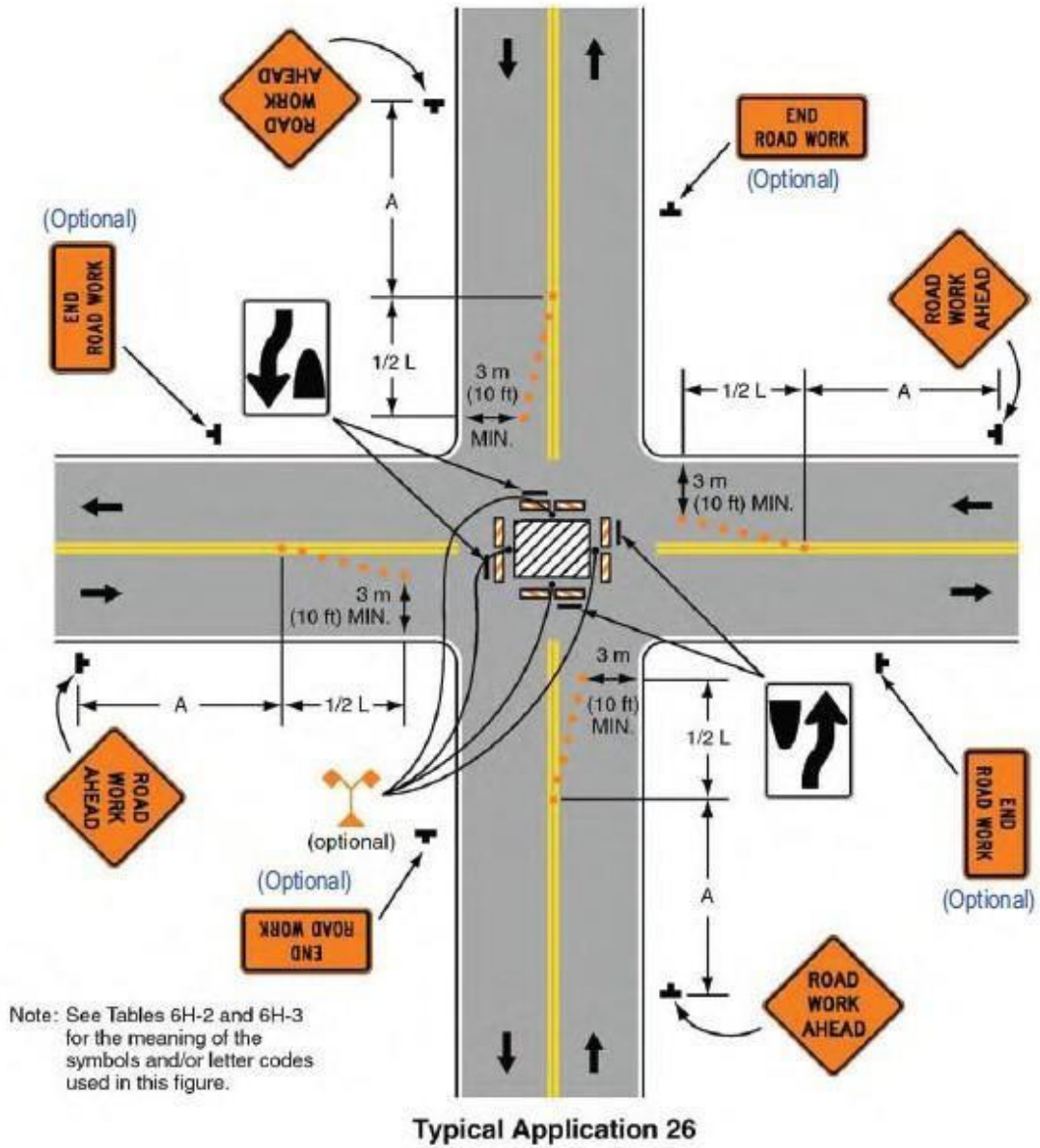

Figure 6H-27. Closure at Side of Intersection (TA-27)

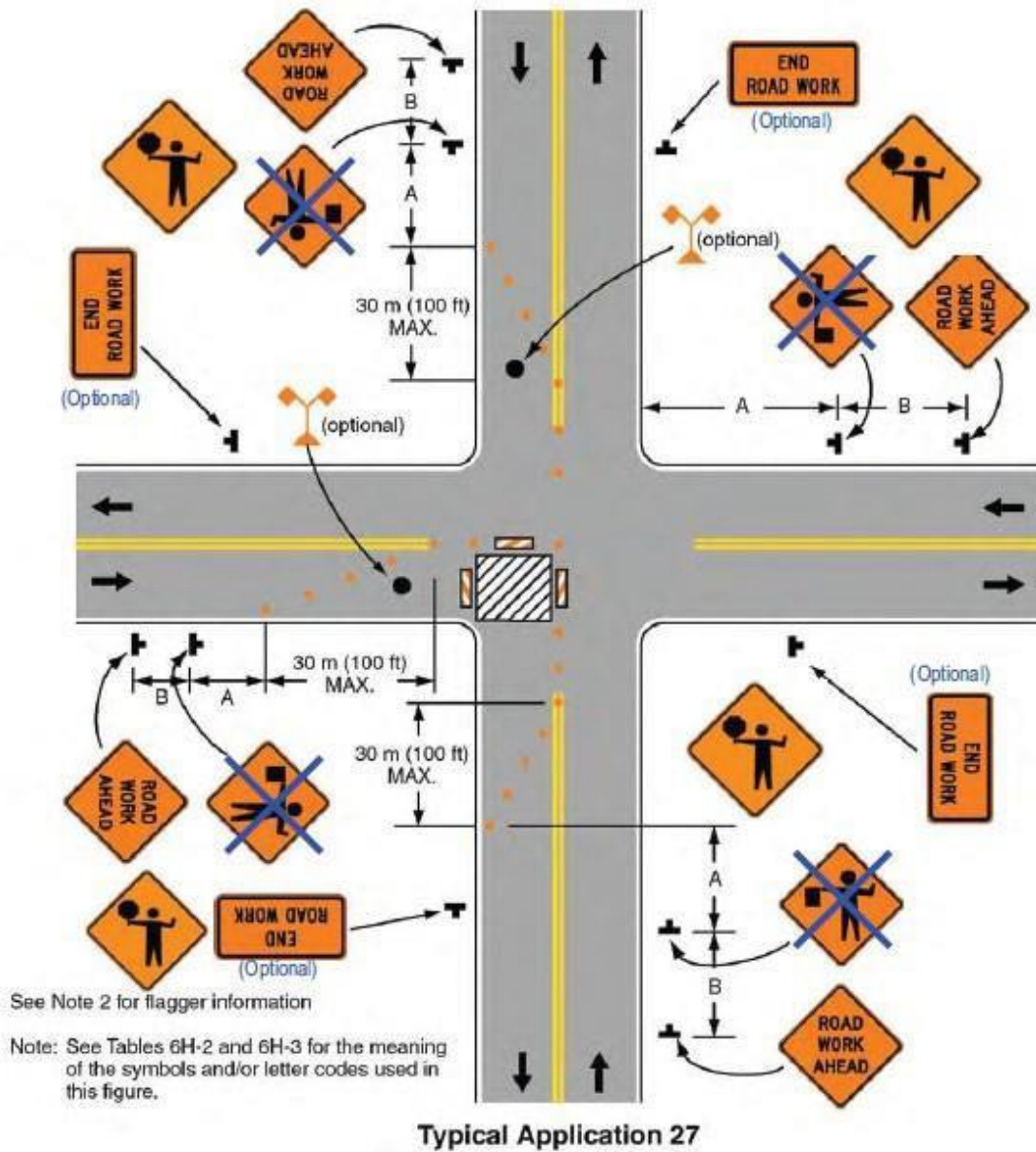

Figure 6H-30. Interior Lane Closure on Multi-lane Street (TA-30)

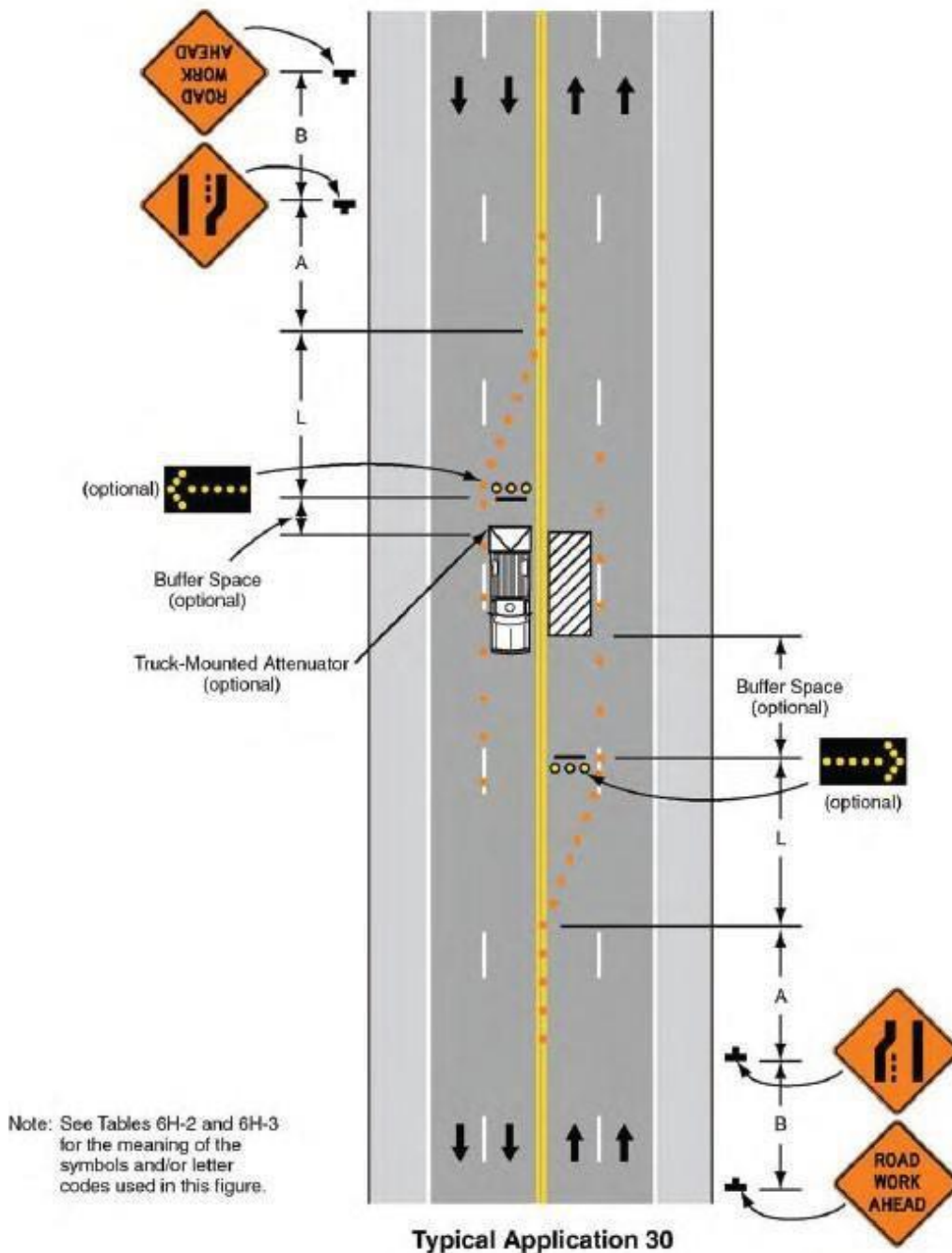
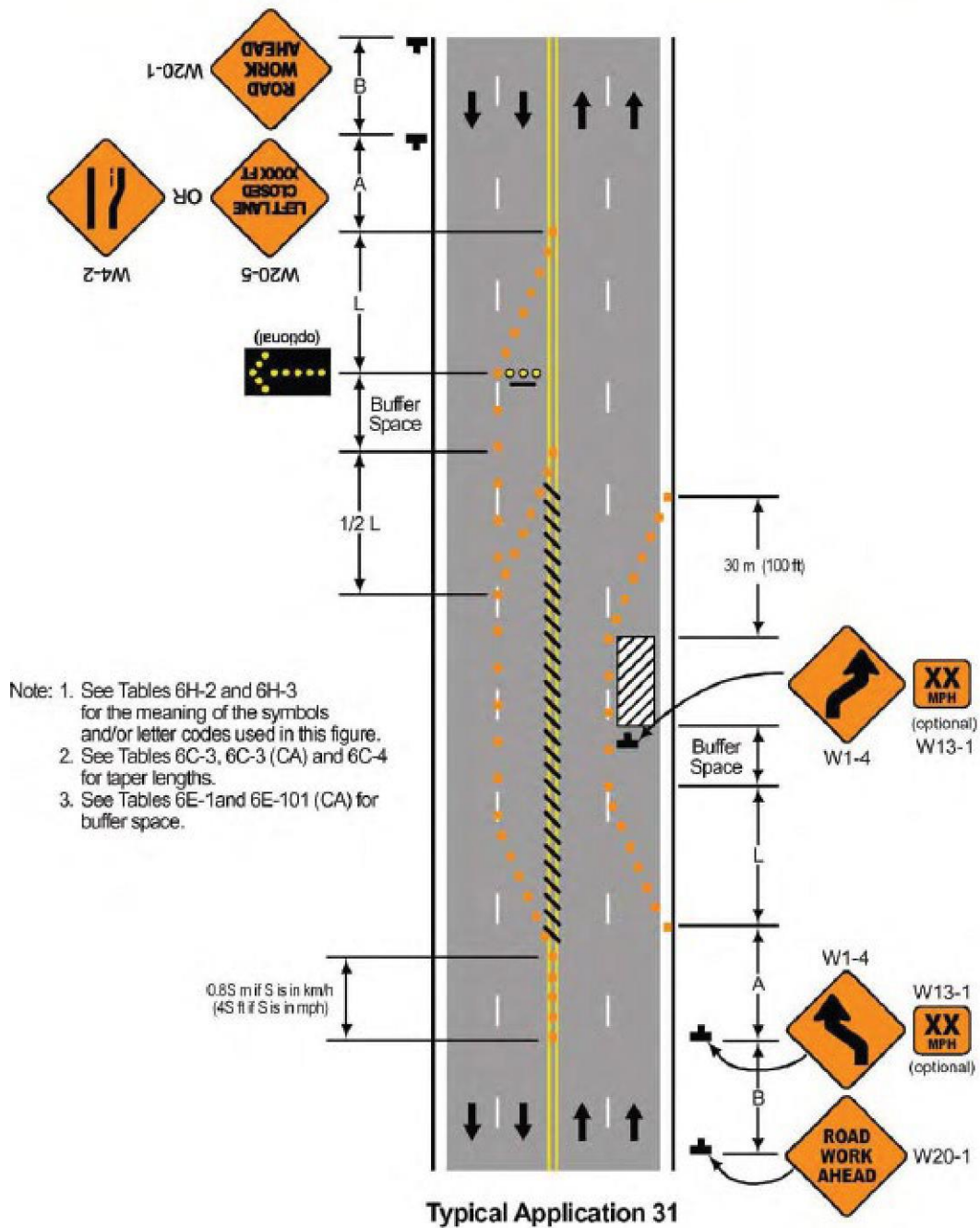

Figure 6H-31 (CA). Lane Closures on Street with Uneven Directional Volumes (TA-31)







# SIDEWALK / WALKWAY CLOSURES

Special Traffic Permits are REQUIRED for all sidewalk and walkway closures

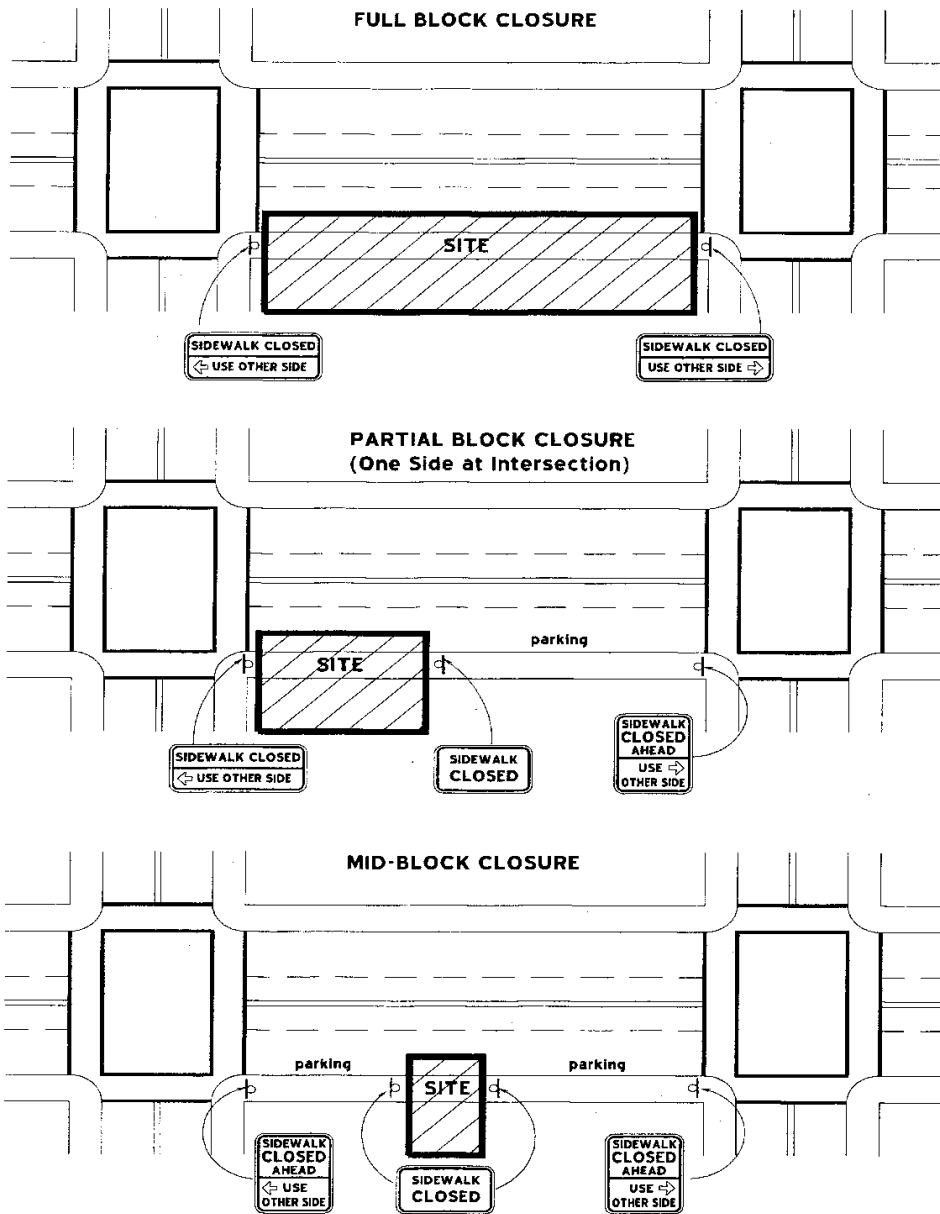

A "Block" is defined as between two major streets (alleys do not define the end of a block)  
Do Not direct pedestrians to cross the street at alleyway intersections

Figure 6H-28. Sidewalk Detour or Diversion (TA-28)

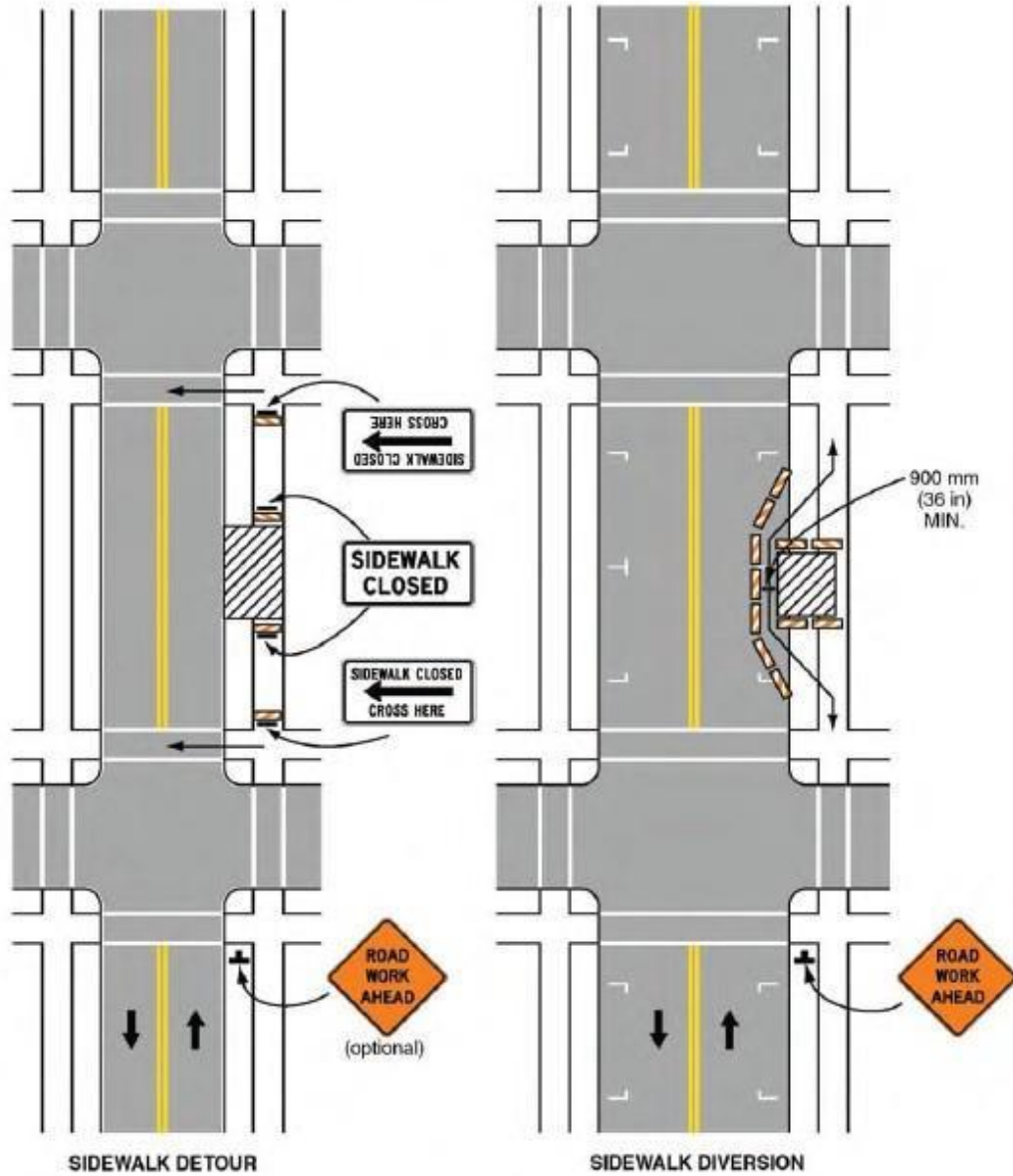

Typical Application 28

Note: See Tables 6H-2 and 6H-3 for the meaning of the symbols and/or letter codes used in this figure.

Figure 6H-29. Crosswalk Closures and Pedestrian Detours (TA-29)

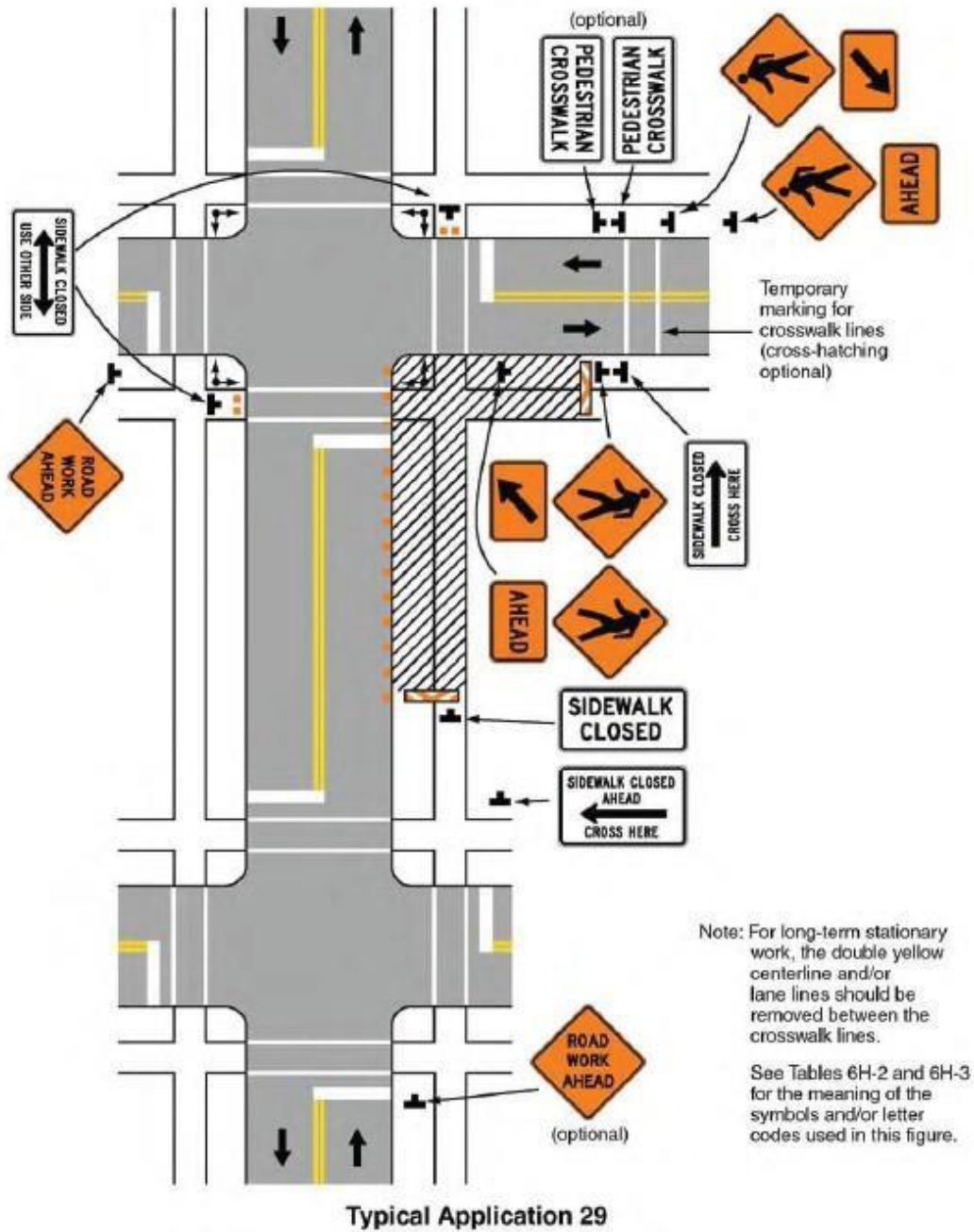

**APPENDIX G: CONTACT INFORMATION**  
**ADDRESSES AND PHONE NUMBERS**



## **CONTACT INFORMATION**

### **SAN FRANCISCO MUNICIPAL TRANSPORTATION AGENCY (SFMTA)**

<https://www.sfmta.com/>

1 South Van Ness Avenue, 7th Floor  
San Francisco, CA 94103-5417

Special Traffic Permit  
[trafficpermits@sfmta.com](mailto:trafficpermits@sfmta.com)

Register Construction Tow Away Zones      Dial 311  
<https://www.sfmta.com/permits/construction-tow-away-zones>

Parking Enforcement	415.553.1200
SFMTA Paint Shop	415.401.3771
SFMTA Sign Shop	415.401.3765
SFMTA Meter Shop	415.401.3788
SFMTA Meter/Sign/Paint FAX	415.822.2346
SFMTA Signal Shop	415.401.3700
SFMTA Signal FAX	415.334.1017
SFMTA Temp Sign Shop	415.401.3781

SFMTA Special Operations  
[constructionrequest@sfmta.com](mailto:constructionrequest@sfmta.com)

Transit Management Center	415.565.3116
Paint Shop MUNI	415.401.3164

### **SAN FRANCISCO PUBLIC WORKS (SFPW)**

<https://www.sfpw.org/>

Bureau of Street-Use & Mapping 49 South Van Ness Avenue, Suite 300 San Francisco, CA 94103	628.271.2000
--	--------------

SFPW Construction Service Counter 1660 Mission Street San Francisco, CA 94103	628.652.3200
---	--------------

Permits:  
Excavation  
Temporary Occupancy  
Street Space  
Tree Trimming

### **SAN FRANCISCO RECREATION AND PARK DEPARTMENT (RPD)**

<https://sfrecpark.org/>

McLaren Lodge & Annex 501 Stanyan Street San Francisco, CA 94117	415.831.2700
--	--------------

### **TRANSIT (MUNI)** <https://www.sfmta.com/>

General Information	415.673.6864
---------------------	--------------

### **SAN FRANCISCO POLICE DEPARTMENT (SFPD)**

Dispatch Center	415.553.0123
Police Coordinators	See Map 5 (Appendix D)

### **CITY SERVICES AND QUESTIONS**

Dial 311

**APPENDIX H: FORMS**





# HOLIDAY MORATORIUM



City and County of San Francisco

## BUSINESS BLOCK SURVEY

Submit **ONE** sheet per block. Requests must be emailed to [trafficpermits@sfmta.com](mailto:trafficpermits@sfmta.com).

This form must be complete and legible.

**Use this form to** A. Request a "Conditional Approval" to work (on or in blocks outside the map area and under 75% business frontage)

**OR if "Conditional Approval to Work" is denied then follow steps B and C:**

**B. Determine if a block is a "business block"**

**C. Request a SFMTA waiver of the moratorium restrictions (you MUST also apply for a Special Traffic Permit)**

*Special Traffic Permit Required to work on blocks that are 50% or more business frontage in addition to conditional approvals and/or waivers*

1. Contact Person: \_\_\_\_\_ Email: \_\_\_\_\_

Name of Company: \_\_\_\_\_ Phone (site): \_\_\_\_\_

2. Streets (Main St, From St, To Street, no minor streets or alleys)

Main Street: \_\_\_\_\_

From Cross Street A: \_\_\_\_\_ To Cross Street B: \_\_\_\_\_

3. Moratorium map: Sketches **MUST** include the following (incomplete submittals may be rejected):

- a. **Property Lines:** Show **all** property lines on **both sides** of the street for the entire block (between major cross streets (alleys do not define the end of any block for this purpose).
- b. **Street Names:** Indicate street names for the major streets (draw alleys in the middle of the block and label).
- c. **Name of Business:** Show the name of each street level business or entity for each property on the diagram.
- d. **Type of Business:** Indicate the type of business for each property (i.e. retail / hotel / restaurant / bar / service / residential / vacant / construction site / etc.).
- e. **Hours and Days of Operation (or hours OPEN)** for each business (property).
- f. **Dimensions:** Show the linear dimension for each property as measured along the street.

4. Work date(s): \_\_\_\_\_  Everyday  Mon-Fri  Other Work Hours: \_\_\_\_\_ to \_\_\_\_\_

5. Attach a completed Special Traffic Permit application and drawing(s) that best represent the work expected

### The Holiday Moratorium

The Holiday Moratorium restricts work in the streets and sidewalks in the City of San Francisco from the day after Thanksgiving through January 1 between the hours of 7AM and 10PM. No work is allowed in the streets or sidewalks 1) in the area outlined in the "Holiday Restrictions Boundary" map in the Regulations for Working in San Francisco Streets ("Blue Book"); or 2) on any business block. A "business block" is defined as a block in which at least 50% of the linear frontage is devoted to business and applies to blocks outside the map area. *(Alleys are not included in the Holiday Moratorium restriction unless they meet the criteria of a "business block." Alleys are defined as streets under 25' wide from curb to curb).* Establishments in this protected category are retail stores, bars, restaurants, service type businesses, non-residence type hotels, or others as determined by the Director of Streets Division, for which the building includes a public entry on the subject street. Applicants may apply for "**Conditional Approval**" to work on any street that has up to 75% business and is not in the map area by filling out this form. If granted, applicant may work as long as no valid objection is received at SFMTA. Following any valid objection, Conditional Approval may be revoked and work ceased until the applicant receives a standard Holiday Moratorium waiver using items B and C above.

#### **For SFMTA Use Only:**

Applicant is granted Conditional Approval to work on this block:  Yes  No; Date: \_\_\_\_\_ Engineer: \_\_\_\_\_

Conditional Approval REVOKED (objection received): Date: \_\_\_\_\_ Engineer: \_\_\_\_\_

This block is under Moratorium (defined by survey): \_\_\_\_\_ % Business;  Yes  No; Date: \_\_\_\_\_ Engineer: \_\_\_\_\_

Applicant is granted a WAIVER to work on this block:  Yes  No; Date: \_\_\_\_\_ Engineer: \_\_\_\_\_

Comment(s): \_\_\_\_\_



SFMTA

# Special Traffic Permit Application

Minimum 2 working days for processing  
Minimum 2 months notice for complex permits (Tower Crane, Foundation Pour, etc.)



Transportation Engineering  
Sustainable Streets  
City and County of San Francisco

Email to: [trafficpermits@sfmta.com](mailto:trafficpermits@sfmta.com)  
Please print. All items **MUST** be completed.  
Renewals: edit and send us your old permit

Fee subject to change

- Your SFPW Permit Number: \_\_\_\_\_  
Type of permit:  Street Space  Excavation  Temporary Occupancy  City Contract  Other (indicate)
- Contact Person: \_\_\_\_\_ Email: \_\_\_\_\_  
Name of Company: \_\_\_\_\_ Phone: \_\_\_\_\_
- Describe type of work to be performed: \_\_\_\_\_
- Location of work and nearest cross streets: \_\_\_\_\_
- Work date(s): \_\_\_\_\_  Everyday  Mon-Fri  Other Work hours: \_\_\_\_\_ to \_\_\_\_\_
- Sketch of work area. **We recommend using SFMTA Striping Drawings as a base.** Striping drawings for streets with painted lane lines are generally available from the following link: <https://www.sfmta.com/reports/striping-drawings>. If SFMTA does not have a striping plan for your location, use the space below to draw a sketch. Sketches (hand drawn or on striping plans) **MUST** include the following (incomplete submittals may be rejected):
  - Drawing** (8½ x11 or 11x17) of the full width of all streets adjacent to the site. Include the entire block in which your work is located for every street that is adjacent to your site. Add attachments as required.
  - Street names**, direction of one-way streets and North arrow.
  - Roadway striping** (the lane lines and any pavement arrows for turn lanes) on each street.
  - Work area** (area you plan to use), number and width of open lanes, and sidewalk / walkways (if open / closed).
  - Dimensions** of street widths (curb to curb), sidewalk widths, lane widths, distances to the next major street in each direction, the proposed work area, existing street space features (temporary walkways or other semi-permanent construction site features), and outdoor dining facilities/parklets occupying the parking lanes.

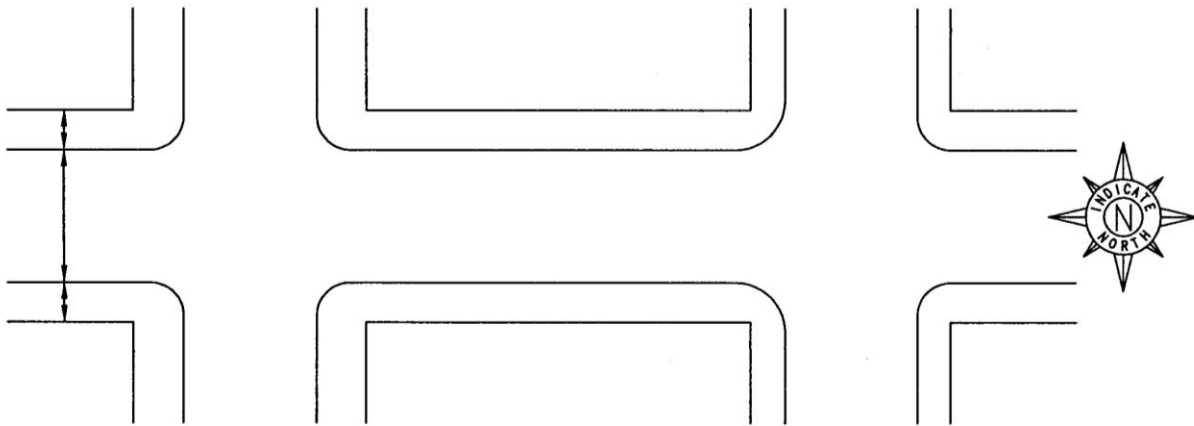

7. Indicate existing parking restrictions adjacent to work area, using the symbols below.

North side: \_\_\_\_\_  
South side: \_\_\_\_\_  
East side: \_\_\_\_\_  
West side: \_\_\_\_\_

Symbols: NP = No Parking (hours)	PP = Permit Parking
NS = No Stopping (hours)	KC = Keep Clear
TA = Tow Away (hours)	BS = Bus Stop
TL = Time Limit (hours)	

To register contractors' Construction Zones "Tow-Away No Stopping" visit [www.sfmta.com/constructiontow](http://www.sfmta.com/constructiontow) and complete the online form at least 72 hours in advance of the desired effective date and time.